

## 承认书

Approval Sheet

客户 (Customer): /

客户料号 (Cus .P/N): /

华联威料号 (HLW P/N): SD5211-110-G68

品名规格 (PronameSpec): MICRO 1.8H SIM 掀盖式 6PIN 卡座

送样日期 (Delivery Date): 2022/08/06

承认日期 (Acknowledge Date): 2022/08/06

Approved No:		客 户 Customer	
采 购 部 Purchasing Dept	品 质 部 QC Dept	工 程 部 Engineering Dept	确 认 Approved By
深 圳 市 华 联 威 电 子 科 技 有 限 公 司 SHEN ZHEN SHI HUA LIAN WEI ELECTRONICS TECHNOLOGY CO; LTD.			
业 务 部 Sales Dept	品 管 部 QC Dept	工 程 部 Engineering Dept	核 准 Checked By
陈虹熹	欠必锋	杨桂锋	唐竹君

地址: 深圳市龙华区观澜街道桂香社区观澜桂花路 307 号

TEL: 0755-28888886 28888866

邮箱: hua@hlwconn.com

[Http://www.hlwconn.com](http://www.hlwconn.com)

# 目 录

## Contents

图纸.....	Page03
产品规格书.....	Page04-09
产品检测报告.....	Page10-11
尺寸测试报告.....	Page12
电镀报告.....	Page13-14
盐雾报告.....	Page15
材质证明.....	Page16-18
SGS.....	Page19-56

REV.	ECN.NO.	APPD.
A	/	/

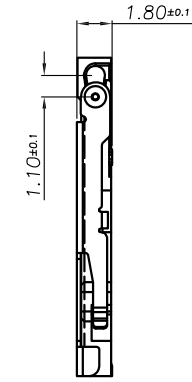
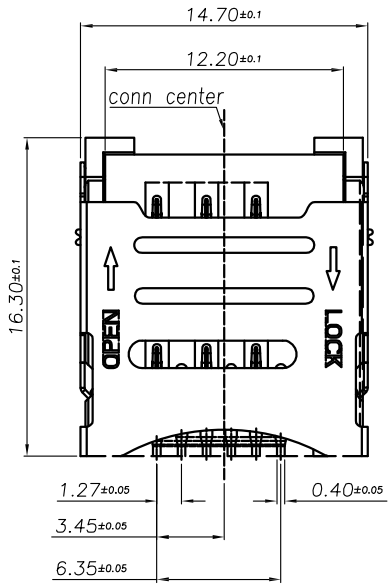

LOCK CARD TATUS

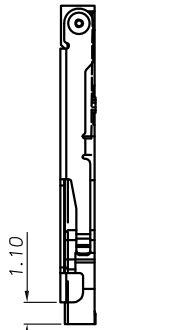

OPEN CARD TATUS

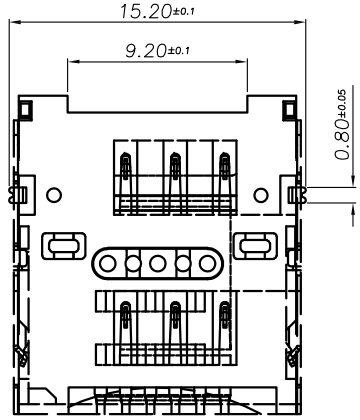

\*Electrical Characteristics:  
 Contact Current Rating:0.5 Amperes.  
 Dielectric Withstanding Voltage:AC500V r.m.s.  
 Insulation Resistance:1000 MΩ Minimum.  
 Contact Resistance:100 mΩ Maximum.  
 \*Environmental:  
 Operating Temperature:-25°C~+90°C.  
 \*Environmental:  
 Mating Cycles:5000~10,000 Insertions.  
 \*Mechanical Characteristics:  
 Card Push Insertion/Out Force:1.4kgf. MAX  
 Contact Separation Force:0.20kgf Minimum.  
 \*Material:  
 Insulator:HI-Temp Plastic UL 94V-0 Rated.  
 Contact:Copper Alloy(t=0.15mm).  
 Shell:Stainless Steel(t=0.20mm).  
 Spring:SWP.

SD5211-110-G68  
 G:半金G/Fu 6:LCP黑色

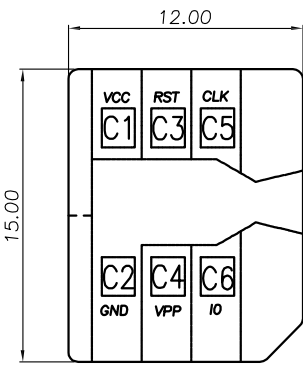
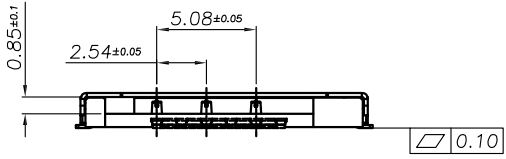

MICRO SIM

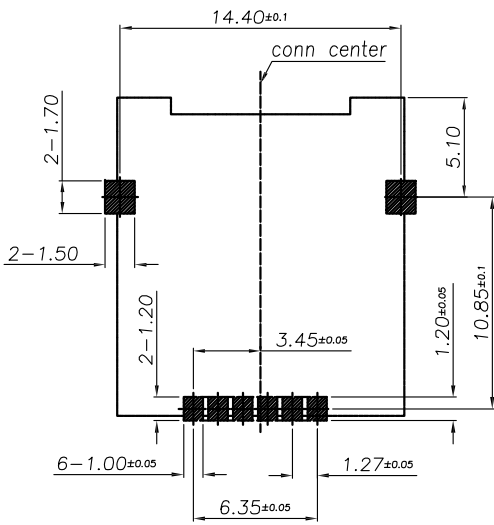
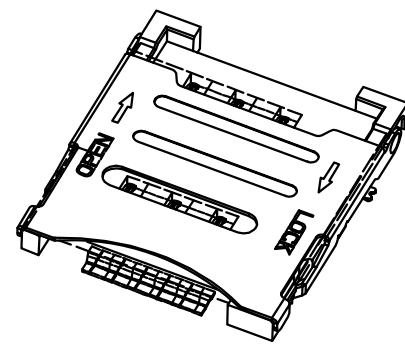

RECOMMENDED PCB LAYOUT(Top View)  
 GENERAL TOLERANCE ±0.05

PIN NO.	NAME	PIN NO.	NAME
C1	VCC	C4	VPP
C2	GND	C5	CLK
C3	RST	C6	IO

TOLERANCE UNLESS OTHERWISE SPECIFIED	
.XXX ±0.10	.X' ±3'
.XX ±0.20	.XX' ±2'
.X ±0.30	

**FLW** 深圳市华联威电子科技有限公司  
 HUA LIAN WEI TECHNOLOGY ELECTRONICS CO;LTD.

APPROVED		PART NAME:	MICRO 1.8H SIM 掀盖式6PIN卡座			
CHECKED		PART No:	SD5211-110-G68	C		
DRAWN	chenyiting	PROJECTION:	UNIT:	SCALE:	SHEET:	REV.
DATE	2023.04.19		mm	1:1	10F1	A



深圳市华联威电子科技有限公司

HUA LIAN WEI TECHNOLOGY ELECTRONICS CO., LTD

## 1. 一般规格 General Specification

### 1.1 额定电流 Current Rating

0.5A Max. AC(rms)/DC /Contact

### 1.2 额定电压 Voltage Rating

100V Max. AC(rms)/DC /Contact

1.3 工作环境 Operating Environment 温度 Temperature: -55 °C~+85 °C 湿度 Humidity: 90~95% maximum

1.4 储存环境 Storage Environment 温度 Temperature: -25C~+80C 湿度 Humidity: 70% maximum

### 1.5 测试环境 Test Environment

温度 Temperature: +10C ~+30C 湿度 Humidity: 45%~75% 大气压 Atmospheric Pressure: 86-106KPA

## 2. 材料及尺寸 Material and dimensions

### 2.1 产品材料 Product Material:

塑胶主体 housing: 耐高温,热塑性材料,阻燃等级 UL94V-0, 颜色: 黑色 High temperature, Thermo-plastic, Color Black, UL94V-0.

端子 contact: 铜合金 Copper Alloy 外壳 shell: 不锈钢 stainless steel

2.2 产品尺寸及电镀 Product dimensions and plating: 请参考所附客户图或物料编码原则 please refer to the attached drawing or product numbering code

3.3 产品有害物质符合厂内 ROHS 有关规定.

The harmful material should be compliance to requirement about ROHS.

### 3. 产品外观 PRODUCT APPEARANCE

项目 ITEM	描述 Description	测试方法 Test Methods	测试规格 Test Specification
3-1	产品外观 Examination of Product	依据 IEC512-2 测试 1a&1b 肉眼观察，产品外形必须符合图纸要求。	产品外观良好，无外观不良情形，产品结构及尺寸亦须符合图纸设计要求。
		IEC512-2 method 1a and 1b Shall be confirmed with eyes in accordance with each drawing.	Outward appearance shall be good without such injurious problem and structure shall be meet the design and dimension requirement of drawing
3-2	电镀膜厚测试 Plating Thickness Measurement	肉眼观察电镀层外观并使用适当的仪器设备进行膜厚测试	电镀层须良好无外观不良情况，电镀膜厚测试须满足设计或图纸需求
		Shall be confirmed with eyes in accordance with each drawing. Shall be confirmed by using proper measuring instruments	Outward appearance shall be good without such injurious problem and thickness shall be meet the design requirement of drawing

### 4. 机械性能 MECHANICAL PERFORMANCE

项目 ITEM	描述 Description	测试方法 Test Methods	测试规格 Test Specification
6-1	耐插拔 Durability	插拔 5000 次，插拔速度 10 次/分钟。 IEC512-5 方法 9a	1. 产品外观符合需求，无破损及外形损伤。 2. 试验后接触电阻最大:50mq
		When mate /un-mate up to 5000 cycles repeatedly at a rate of 5cycles/min. IEC512-5 method 9a.	1. Shall meet visual requirement, show no physical damage. 2. After test: 50mq Max.
6-2	插入力 Insertion force	插入的速度为 25mm/分钟 EIA-364-13B	最大 40N
			40N MAX
6-3	拔出力 Pull out force	拔出的速度为 25mm/分钟 EIA-364-13B	最小 1.0N
			1.0N MIN

## 5. 电气特性 ELECTRICAL PERFORMANCE

项目 ITEM	描述 Description	测试方法 Test Methods	测试规格 Test Specification
5-1	绝缘阻抗 Insulation Resistance	加 500V DC 的电压于相邻两端子之间 1 分钟. IEC512-2 测试 3a 方法 B	1000 兆欧姆最小
		Mated connectors, Apply DC 500V for one minute between adjacent terminal.	1000 M Ohm MIN.
5-2	接触电阻 Contact Resistance	一组对插好的连接器; 测试开路电压:20mV max.; 测试短路电流: 10m A max. IEC512-2 测试 2a	100 毫欧姆最大
		Mated connectors, measure by dry circuit: 20m V Max. 10m A Max. IEC512-2 Test 2a	100 m Ohm Max.
5-3	耐电压 Dielectric withstanding Voltage	加 500V AC 的电压于相邻两端子之间 1 分钟. IEC512-2, 测试 4a	不能有损坏或跳火漏电电流低于 0.5mA
		Mated connectors, Apply AC 500V for one minute between adjacent terminal. IEC512-2 Test 4a	There should be no damage or spark leakage current less than 0.5mA

## 6. 环境特性 ENVIROMENT PERFORMANCE

项目 ITEM	描述 Description	测试方法 Test Methods	测试规格 Test Specification
6-1	耐热性 Thermal Aging	先在温度为 $85 \pm 2^\circ\text{C}$ 环境中放置 96 小 时, 取出于常湿常温中放置 1~2 小时后 测试 接触阻抗.(MIL-STD 202 method 108)	试验后接触电阻最大: 50mq 外观应无损伤
		Mated connectors and expose to $85 \pm 2^\circ\text{C}$ for 96 hours, Upon completion of the exposure period, the test specimens shall be conditioned at ambient room conditions for 1 to 2 hours, after which the specified measurements shall be performed.(MIL-STD 202 method 108)	After test: 50mq Max. Appearance: No damage.

6-2	耐寒性 Cold Aging	先在温度为 $-55 \pm 3^{\circ} \text{C}$ 环境中放置 96 小时,取出于常湿常温中放置 1~2 小时后 测试接触阻抗	试验后接触电阻最大:50mq 外观应无损伤
		Mated connectors and expose to $-55 \pm 3 \text{C}$ for 96 hours, Upon completion of the exposure period, the test specimens shall be conditioned at ambient room conditions for 1 to 2 hours, after which the specified measurements shall be performed.	After test: 50mq Max. Appearance: no damage.
6-3	耐湿性 Humidity	在温度为 $60 \pm 2\text{C}$ ,湿度为 $90 \square 95\%$ 环境 中 放置 96 小时后,常温常湿中放置 $1 \square 2$ 小时后测定 . (MIL-STD-202 method 103)	试验后接触电阻最大:50mq 绝缘电阻: 1000 Mq MIN. 耐压测试: 500V AC, 1 分钟 外观应无损伤
		$60 \pm 2\text{C}$ ,Humidity $90 \square 95\%$ Duration: 96 hours upon completion of the exposure period ,the test specimens shall be conditioned At ambient room conditions for 1 to 2 Hours, after which the specified Measurements shall be performed. (MIL-STD-202 method 103)	After test: 50mq Max. Insulation Resistance: 1000Mq Min. Dielectric strength: 500V AC Appearance: No damage.
6-4	温度循环 Temperature cycling	在 $-55+0/-3\text{C}$ 中放置 30 分钟, 然后在常 温 $25 \text{C}$ 中放置最多 5 分钟,接着在 $85+3/-0\text{C}$ 中 放置 30 分钟, 最后在常温 中放置最多 5 分钟,如此循环五次后,常 温常湿中放置 $1 \square 2$ 小时后测定. IEC512 测试 13d.	试验后接触电阻最大: 50mq 外观应无损伤
		Mated connectors and subject to the Following conditions for 5 cycles. upon Completion of the exposure period, the Test specimens shall be conditoned at Ambient room conditions for 1 to 2 Hours, after which the specified Measurements shall be performed.	After test: 50mq Max. Appearance: No damage

6-5	焊接性 Solder ability	将产品 Tail 端浸入 260±5 °C 的溶锡中 3±0.5 秒,本体底部浸入深度 0.5mm IEC512-6 测试 12a	沾锡面积 95%以上, 无针孔。
		Dip solder-tails into the molten solder (held at 260±5°C ) up to 0.5mm from The bottom of the housing for 3±0.5sec. IEC512-6 test 12a	More than 95% of immersed area must show no voids, pin holes.
6-6	耐回流焊热 Resistance to Reflow Soldering Heat		外观应无损伤（端子不应松动，塑胶不应变形） No damage.
6-7	盐雾测试 Salt spray	对插产品测试环境: 温度: 35±2C, 盐 水浓度:重量比 5±1%, 时间: 24 小时. 测试后常温水洗,干燥. EIA-364-26B	外观: 无损伤; 试验后接触电阻最大:50mq
		Mated connectors and expose to the following salt mist conditions. Upon Completion of the exposure period, salt deposits shall be removed by a gentle Wash or dip in running water, after which the specified measurement shall Be performed. NaCl solution: Concentration: 5±1% Spray time:24 hours ambient Temperature: 35±2C EIA-364-26B	Appearance: no damage. After test: 50mq Max.



## 7. 产品信赖性测试顺序 TEST SEQUECCE

	1	2	3	4	5	6	7	8		
Examination of product	1,8	1,7	1,9	1	1,5	1,5	1	1		
Contact Resistance	2,4,6,7	2,6	2,8		2,4	2,4				
Insulation Resistance			3,7							
Dielectric Withstanding Voltage			4,6							
Insertion Force		3								
Withdrawal Force		4								
Retention Force				2						
Durability		5								
Humidity			5							
Temperature cycling	3									
Salt spray					3					
Thermal Aging	5									
Cold aging						3				
Solder ability							2			
Resistance to Solder heat								2		
Test samples/group	2	2	2	2		2	2	2		

核准：唐竹君

制作人：覃裕华



# 測試報告

TEST REPORT

產品名稱 Part	MICRO 1.8H SIM 掀盖式 6PIN卡座	測試日期 Date of Testing	2022.08.06- 2022.08.06	報告編號 Report NO.	MD2022080612
產品型號 Part	SD5211-110-G68	樣品數量 Quantity	5PCS	測試環境 Date of Testing	濕度 Temp:18~21℃ 相 對濕度 R.H.:49%~57%

## 一. 電性測試 ELECTRICAL TEST

序號 NO	測試項目 Testing Item	測試條件 Testing Conditions	測試設備 Testing Equipments	規格 SPEC	測試記錄Testing Result					判定 Judge	
					1	2	3	4	5	OK	NG
1	接觸阻抗	100 m Ohm	直流低電阻測試儀	100 m Ohm Max	90.2m Ohm Ω	89.8m Ohm Ω	91.5m Ohm Ω	92.0m Ohm Ω	98.53m Ohm Ω	V	
2	絕緣阻抗	1000 M Ohm VDC	絕緣電阻測試儀	1000 M Ohm Min	Pass	Pass	Pass	Pass	Pass	V	
3	耐壓測試	500V AC / 0.5 mA 1分钟	耐壓測試儀	No damaged	OK	OK	OK	OK	OK	V	

## 二. 机械特性測試 MECHANICAL TEST

序號 NO	測試項目 Testing Item	測試條件 Testing Conditions	測試設備 Testing Equipments	規格 SPEC	測試記錄Testing Result					判定 Judge	
					1	2	3	4	5	OK	NG
4	插入力	每分钟25±3mm 的速度	插拔力計	40 Max.	36N	35N	32N	30N	29N	V	
5	拔出力	每分钟25±3mm 的速度	插拔力計	1N Min	1.2N	1.4N	1.5N	1.1N	1.3N	V	
6	耐久性	测试速度：每分 钟5个 循环，测试次 数：5000次循 环最少	插拔力計	不得发生物理 损坏。	OK	OK	OK	OK	OK	V	

## 三. 环境特性测试 ENVIRONMENTAL TEST

序號 NO	測試項目 Testing Item	測試條件 Testing Conditions	測試設備 Testing Equipments	規格 SPEC	測試記錄Testing Result					判定 Judge	
					1	2	3	4	5	OK	NG
7	冷热冲击	55+/-3℃ (30 分 钟), +85+/- 2℃ (30 分 钟) 为一个中期的环 境中, 重复 10 个周期	高低温试 验箱	不得发生物理 损坏。	OK	OK	OK	OK	OK	V	

8	湿温循环	温度25~65℃， 湿90~95%，持 续时间:4qw	湿温循环 机	最大接触阻抗 30mΩ	OK	OK	OK	OK	OK	V	
9	盐雾试验	温度:35±2℃ 24小时	盐雾试验 箱	最大接触阻抗 50mΩ	OK	OK	OK	OK	OK	V	
10	可焊性	焊锡温度: 260±5℃	熔锡炉	沾锡面积达 90%以上	OK	OK	OK	OK	OK	V	
11	焊接耐热试 验	260±5℃ 10秒	工业烘烤 箱	不得发生物理 损坏	OK	OK	OK	OK	OK	V	
综合判定TEST JUDGMENT		<input checked="" type="checkbox"/> 合格 (Acceptable) <input type="checkbox"/> 不合格 (Reject)									

核准 (Approver): 欠必锋

测试 (Tester): 但芬

# 深圳市华联威电子科技有限公司

## 檢驗報告

首件檢驗
 入庫檢驗
 出貨檢驗
 客退檢驗
 退料檢驗
 其他
 2022年08月06日 版次:A1

料號	SD5211-110-G68	制令單號	/		送檢單位	工程	首件製作者	裝配					
品名	MICRO 1.8H SIM 掀蓋式 6PIN卡座	客戶代號	/		批 量	/	送檢時間	/					
					數 量	5PCS	確認時間	/					
抽樣標準		<input checked="" type="checkbox"/> 單次 <input type="checkbox"/> 雙次			抽樣數	AQL	CRI:0	MAJ:0.4	MIN:0.65				
MIL-STD-105E(II)		<input checked="" type="checkbox"/> 正常 <input type="checkbox"/> 加嚴 <input type="checkbox"/> 減量			( 5PCS )	ACC/REJ	0	/	/				
不良數:		CRI ( / )		MAJ ( / )		MIN ( / )		不良率(%)	/				
NO.	檢驗項目 單位:MM/G	檢測 儀器	檢 驗 記 錄					品管判定		CRI	MAJ	MIN	備注
			1	2	3	4	5	AC	RE				
尺 寸 測 量	16.30±0.10	D	16.25	16.27	16.29	16.31	16.33	√					
	14.70±0.10	D	14.66	14.68	14.70	14.72	14.74	√					
	12.20±0.10	D	12.12	12.14	12.16	12.18	12.20	√					
	15.20±0.10	D	15.13	15.15	15.17	15.19	15.21	√					
	9.20±0.10	D	9.11	9.13	9.15	9.17	9.19	√					
	0.80±0.05	D	0.77	0.78	0.79	0.80	0.81	√					
	1.80±0.10	D	1.73	1.74	1.75	1.76	1.77	√					
	1.27±0.05	D	1.23	1.25	1.27	1.29	1.31	√					
	3.81±0.05	D	3.77	3.79	3.81	3.83	3.85	√					
	6.35±0.05	D	6.26	6.28	6.30	6.32	6.34	√					
	0.40±0.05	D	0.37	0.38	0.39	0.40	0.41	√					

檢驗依據: 《工程圖紙》 《檢驗規範》 《承認書》 樣品 其它

檢測儀器:A游標卡尺 B千分尺 C厚薄儀 D投影鏡 E放大鏡 F顯微鏡 G錫爐 H插拔力器 I間位尺 J其它

品保判定: 合格Accept 退貨Reject 特采Waive 挑選Sort

核准: 欠必鋒 審核: 李娟 檢驗員: 但芬

电镀报告表

品名:MICRO 1.8H SIM 掀盖式6PIN卡座(外壳)		版次:A.0			
电镀规格:Cu:40u",Ni:30u"	日期:2022/8/3	页次:1/1			
厂商:同华					
测试设备:CMI X-射线膜厚测试仪					
1、表层电镀测试 (Ni)					
数据	测试标准	实测值	判定	测试日期	测试时间
1	30u"min	110.2u"	OK	2022/8/3	11:35:05
2	30u"min	105.9u"	OK	2022/8/3	11:36:07
3	30u"min	108.6u"	OK	2022/8/3	11:37:09
4	30u"min	109.8u"	OK	2022/8/3	11:38:11
2、底层电镀测试 (Cu)					
数据	测试标准	实测值	判定	测试日期	测试时间
1	30u"min	86.5u"	OK	2022/8/3	11:35:05
2	30u"min	72.3u"	OK	2022/8/3	11:36:07
3	30u"min	84.7u"	OK	2022/8/3	11:37:09
4	30u"min	81.1u"	OK	2022/8/3	11:38:11

核准: 欠必锋

审核: 李娟

检验员: 但芬

## 电镀报告表

品名:MICRO 1.8H SIM 掀盖式6PIN卡座(端子)					
电镀规格:Ni40u", Sn40u", Au G/Fu"			日期:2022/8/1		页次:1/1
厂商:同华					
测试设备:CMI X-射线膜厚测试仪					
1、底层电镀测试(Ni)					
数据	测试标准	实测值	判定	测试日期	测试时间
1	40u"MIN	45.3u"	OK	2022/8/1	13:50:12
2	40u"MIN	48.5u"	OK	2022/8/1	13:50:14
3	40u"MIN	44.2u"	OK	2022/8/1	13:50:16
4	40u"MIN	45.6u"	OK	2022/8/1	13:50:18
2、表层电镀测试(Sn)					
数据	测试标准	实测值	判定	测试日期	测试时间
1	40u"MIN	43.3u"	OK	2022/8/1	14:10:36
2	40u"MIN	42.4u"	OK	2022/8/1	14:10:38
3	40u"MIN	46.7u"	OK	2022/8/1	14:10:40
4	40u"MIN	43.1u"	OK	2022/8/1	14:10:42
3、表层电镀测试(Au)					
数据	测试标准	实测值	判定	测试日期	测试时间
1	0.5u"MIN	0.56u"	OK	2022/8/1	14:18:20
2	0.5u"MIN	0.58u"	OK	2022/8/1	14:18:22
3	0.5u"MIN	0.59u"	OK	2022/8/1	14:18:24
4	0.5u"MIN	0.57u"	OK	2022/8/1	14:18:26

核准: 欠必锋

审核: 李娟

检验员: 但芬

## 盐水喷雾实验报告

试验方法	盐水喷雾腐蚀试验法	参考资料	MIL-STD-1216
METHOD	NEUTRL SALT SPRAY CORROSION TEST	REF	
客户	/	试验起始日期	2022年08月05日 08:00 时起
		DATE	2022年08月06日 08:00 时止
样品名称	MICRO 1.8H SIM 掀盖式6PIN卡座	试验数量	5PCS
P/N	SD5211-110-G68		

## 试验条件 (TEST CONDITION)

- 1、盐水溶解 (SALT SOLUTION: 浓度 $50 \pm 10\text{g/L}$ , PH值6.5-7.2).
- 2、试验室温度 (TEMP. IT THE SPRAY DHAMBR):  $35 \pm 1^\circ\text{C}$ .
- 3、盐水桶温度 (TEMP. OF SALE SOL' N TANK):  $35 \pm 1^\circ\text{C}$ .
- 4、压力桶温度 (TEMP. OF SAR SUPPLIERY):  $47 \pm 1^\circ\text{C}$ .
- 5、试验室相对湿度 (R. H IN THE CHAMBER) 85%.
- 6、压缩空气压力 (COMPRESSED AIR PRESSURE):  $1.00 \pm 0.01\text{Kg/cm}^2$ .
- 7、样品放置位置 (SPECIMEN SUPPORTED ANGLE): 尼龙绳吊挂 $70^\circ - 90^\circ$ .
- 8、喷雾收集量 (COLLECT RATE OF SALT SOL' N)  $1-2\text{mL}/(8 \text{ cm}^2\text{hr})$ .
- 9、盐雾测试时间: 24小时 (H)

## 判定方法 (ADFUSGD METHOD)

试验后以20倍放大镜观察、无蓝、绿色腐蚀物之现象 (不包含折弯处), 即判定合格. (Inspext the ecimen at 20 xmagnification no blue or green corrosion products are acceptable)

样品序号	试验后现象	判定
	PHENOMENON AFTER TEST	COMMENT
1	无蓝、绿色腐蚀物之现象	OK
2	无蓝、绿色腐蚀物之现象	OK
3	无蓝、绿色腐蚀物之现象	OK
4	无蓝、绿色腐蚀物之现象	OK
5	无蓝、绿色腐蚀物之现象	OK

核准: 欠必锋

审核: 李娟

试验员: 但芬

## Materials Information

**PRODUCT NAME: LCP M-401 BK**

**COMPOSITION/INFORMATION OF LCP M-401 BK**

**SUBSTANCE/MIXTURE: Mixture**

**SYNONYM(S): Aromatic Liquid Crystal Polymer(LCP)**

品名	比例	用途
德众泰 LCP 树脂	0.565	构成材料主要成分
抗氧化剂	0.002	抗氧化
科莱恩热稳定剂	0.003	增加高温稳定性
黑色母	0.01	着色
滑石粉	0.2	增强剂, 增加流动性
玻纤	0.22	增强

NAME OF COMPANY: DZT Engineering Plastics Tech. Co.,Ltd

ADDRESS: Building 2 Zhichong Industrial Park, Hi-Tech Zone, Jiangmen City,  
Guangdong Province, China

SECTION IN CHARGE: Quality Assurance Department

TEL/FAX: +86-750-3689920/+86-750-3689921

EMERGENCY TEL: +86-750-3689708





# 产品质量证明书

## PRODUCT INSPECTION CERTIFICATE

合同号码: Contract No.	20131014003	等级: Grade	1A	品名: Commodity	不锈钢冷轧钢带 (COIL)	牌号: Type	SUS304-CSP 1/2H	钢卷编号: Serial number	13092820
订货方: Order	YU HUA	标准: Specification	JIS G 4313-1996	表面加工: Surface Finish	2B 亮	发行日期: Date	2013-10-15		
供货方: Supplier	东莞鑫发								

序号 No.	产品牌号 Product name	产品尺寸 Product Size					拉伸试验 Tensile Test			表面硬度 Hardness HV	化学成分 Chemical Composition(%)						
		厚度 Thickness mm	宽度 Width mm	长度 Length m	卷数 Number C	重量 Weight Kg	降伏强度 N/mm <sup>2</sup> ≥470	抗拉强度 N/mm <sup>2</sup> ≥780	延伸率 % ≥6		碳 C ≤0.080	硅 Si ≤1.000	锰 Mn ≤2.000	磷 P ≤0.045	硫 S ≤0.030	镍 Ni 8.0-10.5	铬 Cr 18.0-20.0
1	SUS304-CSP 1/2H	0.3	410	COIL	1	1102.3	625	836	7	280	0.072	0.490	1.212	0.042	0.002	8.100	18.020

备注:(Remarks):

1. 尺寸和表面:合格

Size and Surface:Guaranteed

2. 拉伸试验:方法符合JISZ2241标准;试样规格为JISZ2201 5号

Tensile Test:Technique accord with JIS Z 2241;

Sample Specification accord with No.5 of JIS Z 2201

3. 硬度试验:方法符合JIS Z 2244标准

Hardness Test:Technique accord with JIS Z 2244

兹证明所列产品均符合订单和标准的制造要求

WE HEREBY CERTIFY THAT THE MATERIAL HEREIN HAS BEEN  
MADE IN ACCORDANCE WITH THE ORDER AND  
SPECIFICATION

\*此报告仅可完全复制

\*The report can only be copied completely



# 鉅鼎銅材廠檢驗報告單

公司名稱 Customer	鉅鼎銅材廠檢驗報告單				重量 Weight(kg)	1078	出貨日期 Date	2021/11/23		
品名 Article	標準 Standard No				尺寸 Dimension		狀態 Tenper	銅卷編號 Coil No		
C2680	JISH3100:2017				0.18*400		EH	1021-C-08		
化學成分Chemical Compositions(%)										
元素 Element	Cu %	Zn%	Pb%	Fe%	\	\	\	\	化學成分	雜質
規範 Spec	64.0-68.0	餘量	<0.05	<0.05	\	\	\	\	合格	合格
實測 Actual	64.32	餘量	0.0036	0.0136	\	\	\	\	合格	合格
機械性質Mechanical Properties										
項目 Item	結晶粒度 Grain Size Mm	硬度 Hardness Hv	抗拉強度 TensionStrength Mpa	伸長度 Elongation %	導電率 Electrical Conduc %IACS	彎曲試驗 Bending Test 180	表面粗度 Surface Roughness Ra(u m)	彎曲度 Camber mm/n		
規範MAX Spec	\	170-190	490-610	\	\	\	\	\		
實測 Actual	\	178	574	5	\	\	\	\		

品質部



## Test Report

No. CANEC2222380701

Date: 26 Oct 2022

Page 1 of 4

Client Name : SHENZHEN HUALIANWEI ELECTRONICS TECHNOLOGY CO.,LTD

Client Address : 101, 201, PLANT 1, NO.307, GUANLAN GUIHUA ROAD, GUIXIANG COMMUNITY, GUANLAN SUB-DISTRICT, LONGHUA DISTRICT, SHENZHEN CITY, GUANGDONG PROVINCE, CHINA

Sample Name : C2680 Terminal

Model No. : C2680 terminal after plating

Client Ref. Info. : Used for USB series, HDMI series, RJ series, 1394 series, MICRO series, MINI series, DISPLAYPORT series, VGA series, DVI series, TYPE-C series, JACK series

The above sample(s) and information were provided by the client.

SGS Job No. : CP22-057100 - GZ

Date of Sample Received : 20 Oct 2022

Testing Period : 20 Oct 2022 - 26 Oct 2022

Test Requested : Selected test(s) as requested by the client.

Test Method(s) : Please refer to next page(s).

Test Result(s) : Please refer to next page(s).

### Result Summary :

Test Requested	Conclusion
EU RoHS Directive (EU) 2015/863 amending Annex II to Directive 2011/65/EU- Lead, Mercury, Cadmium and Hexavalent chromium	PASS

Signed for and on behalf of  
SGS-CSTC Standards Technical Services Co., Ltd. Guangzhou Branch

*Dongyu Xie*

Dongyu Xie  
Approved Signatory

scan to see the report



A17521CE



Test Result(s) :

Test Part Description :

Specimen No.	SGS Sample ID	Description
SN1	CAN22-223807.001	Silver-grey/brassy metal

Remarks :

- (1) 1 mg/kg = 0.0001%
- (2) MDL = Method Detection Limit
- (3) ND = Not Detected ( < MDL )
- (4) "-" = Not Regulated

**EU RoHS Directive (EU) 2015/863 amending Annex II to Directive 2011/65/EU- Lead, Mercury, Cadmium and Hexavalent chromium**

Test Method : With reference to IEC 62321-4:2013+A1:2017, IEC 62321-5:2013, IEC 62321-7-1:2015, analyzed by ICP-OES and UV-Vis .

<u>Test Item(s)</u>	<u>Limit</u>	<u>Unit</u>	<u>MDL</u>	<u>001</u>
Cadmium (Cd)	100	mg/kg	2	ND
Lead (Pb)	1000	mg/kg	2	3
Mercury (Hg)	1000	mg/kg	2	ND
Hexavalent Chromium (Cr(VI))▼	-	µg/cm <sup>2</sup>	0.10	ND

Notes :

- (1) The maximum permissible limit is quoted from RoHS Directive (EU) 2015/863.
  - (2) IEC 62321 series is equivalent to EN 62321 series
  - (3) ▼= a. The sample is positive for CrVI if the CrVI concentration is greater than 0.13 µg/cm<sup>2</sup>. The sample coating is considered to contain CrVI  
 b. The sample is negative for CrVI if CrVI is ND (concentration less than 0.10 µg/cm<sup>2</sup>). The coating is considered a non-CrVI based coating  
 c. The result between 0.10 µg/cm<sup>2</sup> and 0.13 µg/cm<sup>2</sup> is considered to be inconclusive - unavoidable coating variations may influence the determination
- Information on storage conditions and production date of the tested sample is unavailable and thus Cr(VI) results represent status of the sample at the time of testing.

Unless otherwise stated, the decision rule for conformity reporting is based on Binary Statement for Simple Acceptance Rule ( w=0) stated in ILAC-G8:09/2019.



Unless otherwise agreed in writing, this document is issued by the Company subject to its General Conditions of Service printed overleaf, available on request or accessible at <http://www.sgs.com/en/Terms-and-Conditions.aspx> and, for electronic format documents, subject to Terms and Conditions for Electronic Documents at <http://www.sgs.com/en/Terms-and-Conditions/Terms-e-Documents.aspx>. Attention is drawn to the limitation of liability, indemnification and jurisdiction issues defined therein. Any holder of this document is advised that information contained hereon reflects the Company's findings at the time of its intervention only and within the limits of Client's instructions, if any. The Company's sole responsibility is to its Client and this document does not exonerate parties to a transaction from exercising all their rights and obligations under the transaction documents. This document cannot be reproduced except in full, without prior written approval of the Company. Any unauthorized alteration, forgery or falsification of the content or appearance of this document is unlawful and offenders may be prosecuted to the fullest extent of the law. Unless otherwise stated the results shown in this test report refer only to the sample(s) tested.

ATTACHMENTS

Pb/Cd/Hg/Cr<sup>6+</sup> Testing Flow Chart

1) These samples were dissolved totally by pre-conditioning method according to below flow chart. (Cr<sup>6+</sup> test method excluded).

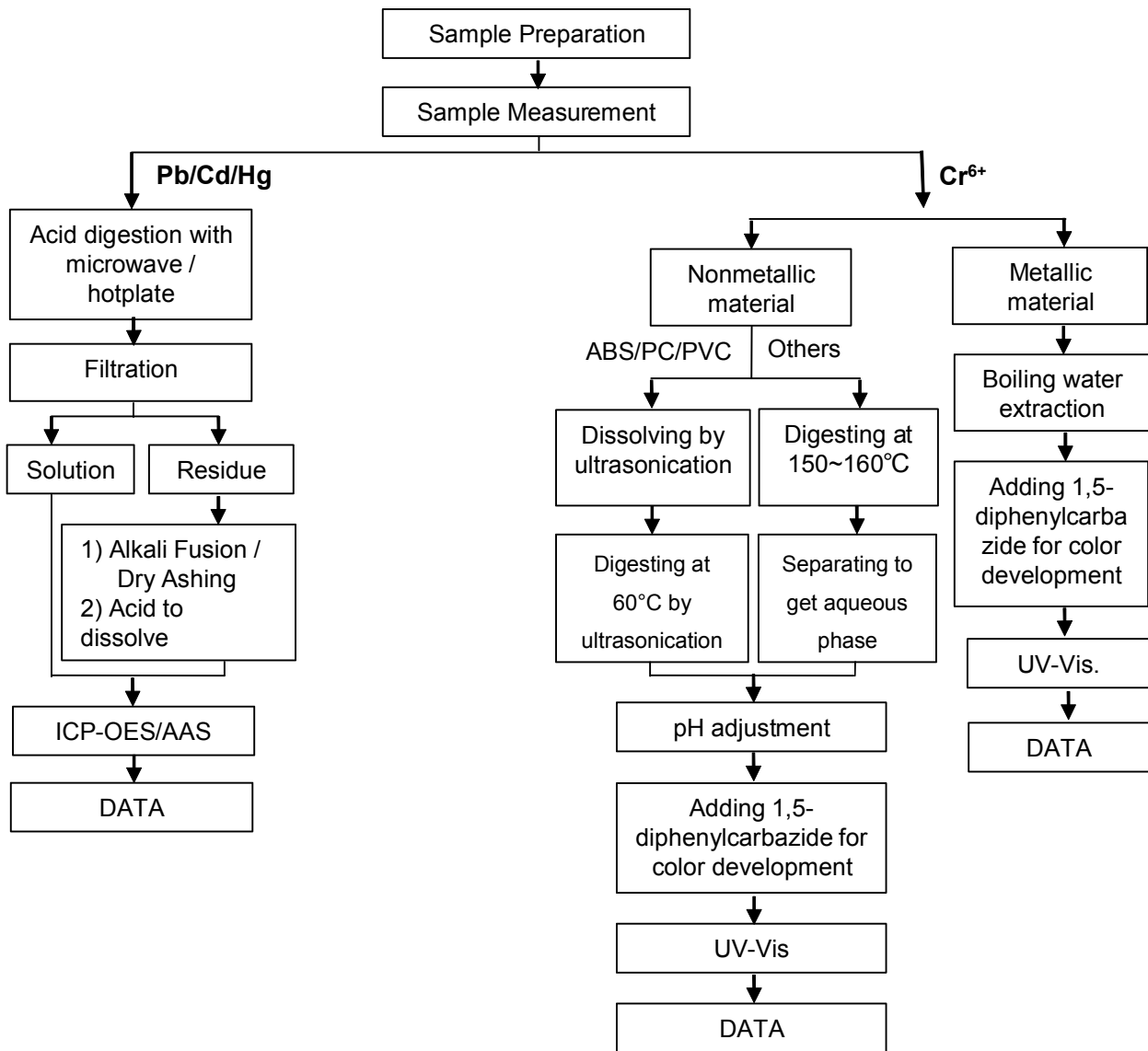

Unless otherwise agreed in writing, this document is issued by the Company subject to its General Conditions of Service printed overleaf, available on request or accessible at <http://www.sgs.com/en/Terms-and-Conditions.aspx> and, for electronic format documents, subject to Terms and Conditions for Electronic Documents at <http://www.sgs.com/en/Terms-and-Conditions/Terms-e-Documents.aspx>. Attention is drawn to the limitation of liability, indemnification and jurisdiction issues defined therein. Any holder of this document is advised that information contained hereon reflects the Company's findings at the time of its intervention only and within the limits of Client's instructions, if any. The Company's sole responsibility is to its Client and this document does not exonerate parties to a transaction from exercising all their rights and obligations under the transaction documents. This document cannot be reproduced except in full, without prior written approval of the Company. Any unauthorized alteration, forgery or falsification of the content or appearance of this document is unlawful and offenders may be prosecuted to the fullest extent of the law. Unless otherwise stated the results shown in this test report refer only to the sample(s) tested.

Attention: To check the authenticity of testing / inspection report & certificate, please contact us at telephone: (86-755) 8307 1443, or email: [CN.Doccheck@sgs.com](mailto:CN.Doccheck@sgs.com)

Sample photo:



SGS authenticate the photo on original report only

\*\*\* End of Report \*\*\*



# Test Report

No. CANEC2222380705

Date: 26 Oct 2022

Page 1 of 4

Client Name : SHENZHEN HUALIANWEI ELECTRONICS TECHNOLOGY CO.,LTD

Client Address : 101, 201, PLANT 1, NO.307, GUANLAN GUIHUA ROAD, GUIXIANG COMMUNITY, GUANLAN SUB-DISTRICT, LONGHUA DISTRICT, SHENZHEN CITY, GUANGDONG PROVINCE, CHINA

Sample Name : SUS304 hardware

Model No. : SUS304

Client Ref. Info. : Used for USB series, HDMI series, RJ series, 1394 series, MICRO series, MINI series, DISPLAYPORT series, VGA series, DVI series, TYPE-C series, JACK series

The above sample(s) and information were provided by the client.

SGS Job No. : CP22-057100 - GZ

Date of Sample Received : 20 Oct 2022

Testing Period : 20 Oct 2022 - 26 Oct 2022

Test Requested : Selected test(s) as requested by the client.

Test Method(s) : Please refer to next page(s).

Test Result(s) : Please refer to next page(s).

Result Summary :

Test Requested	Conclusion
EU RoHS Directive (EU) 2015/863 amending Annex II to Directive 2011/65/EU- Lead, Mercury, Cadmium and Hexavalent chromium	PASS

Signed for and on behalf of  
SGS-CSTC Standards Technical Services Co., Ltd. Guangzhou Branch

*Dongyu Xie*

Dongyu Xie  
Approved Signatory

scan to see the report



565D76FA



SGS-CSTC Standards Technical Services Co., Ltd.  
Guangzhou Branch Testing Center Chemical Laboratory.

Unless otherwise agreed in writing, this document is issued by the Company subject to its General Conditions of Service printed overleaf, available on request or accessible at <http://www.sgs.com/en/Terms-and-Conditions.aspx> and, for electronic format documents, subject to Terms and Conditions for Electronic Documents at <http://www.sgs.com/en/Terms-and-Conditions/Terms-e-Documents.aspx>. Attention is drawn to the limitation of liability, indemnification and jurisdiction issues defined therein. Any holder of this document is advised that information contained hereon reflects the Company's findings at the time of its intervention only and within the limits of Client's instructions, if any. The Company's sole responsibility is to its Client and this document does not exonerate parties to a transaction from exercising all their rights and obligations under the transaction documents. This document cannot be reproduced except in full, without prior written approval of the Company. Any unauthorized alteration, forgery or falsification of the content or appearance of this document is unlawful and offenders may be prosecuted to the fullest extent of the law. Unless otherwise stated the results shown in this test report refer only to the sample(s) tested.

Attention: To check the authenticity of testing / inspection report & certificate, please contact us at telephone: (86-755) 8307 1443, or email: [CN.Doccheck@sgs.com](mailto:CN.Doccheck@sgs.com)

198 Kazhu Road, Sciencetech Park Guangzhou Economic & Technology Development District, Guangzhou, China 510663

中国·广州·经济技术开发区科学城科珠路198号 邮编: 510663

t (86-20) 82155555 [www.sgs.com](http://www.sgs.com)

t (86-20) 82155555 [sgs.china@sgs.com](mailto:sgs.china@sgs.com)

## Test Report

No. CANEC2222380705

Date: 26 Oct 2022

Page 2 of 4

Test Result(s) :

### Test Part Description :

Specimen No.	SGS Sample ID	Description
SN1	CAN22-223807.005	Silver-grey metal

Remarks :

- (1) 1 mg/kg = 0.0001%
- (2) MDL = Method Detection Limit
- (3) ND = Not Detected ( < MDL )
- (4) "-" = Not Regulated

### EU RoHS Directive (EU) 2015/863 amending Annex II to Directive 2011/65/EU- Lead, Mercury, Cadmium and Hexavalent chromium

Test Method : With reference to IEC 62321-4:2013+A1:2017, IEC 62321-5:2013, IEC 62321-7-1:2015, analyzed by ICP-OES and UV-Vis .

Test Item(s)	Limit	Unit	MDL	005
Cadmium (Cd)	100	mg/kg	2	ND
Lead (Pb)	1000	mg/kg	2	ND
Mercury (Hg)	1000	mg/kg	2	ND
Hexavalent Chromium (Cr(VI))▼	-	µg/cm <sup>2</sup>	0.10	ND

Notes :

- (1) The maximum permissible limit is quoted from RoHS Directive (EU) 2015/863.
  - (2) IEC 62321 series is equivalent to EN 62321 series
  - (3) ▼= a. The sample is positive for CrVI if the CrVI concentration is greater than 0.13 µg/cm<sup>2</sup>. The sample coating is considered to contain CrVI  
 b. The sample is negative for CrVI if CrVI is ND (concentration less than 0.10 µg/cm<sup>2</sup>). The coating is considered a non-CrVI based coating  
 c. The result between 0.10 µg/cm<sup>2</sup> and 0.13 µg/cm<sup>2</sup> is considered to be inconclusive - unavoidable coating variations may influence the determination
- Information on storage conditions and production date of the tested sample is unavailable and thus Cr(VI) results represent status of the sample at the time of testing.

Unless otherwise stated, the decision rule for conformity reporting is based on Binary Statement for Simple Acceptance Rule (  $w=0$  ) stated in ILAC-G8:09/2019.



Unless otherwise agreed in writing, this document is issued by the Company subject to its General Conditions of Service printed overleaf, available on request or accessible at <http://www.sgs.com/en/Terms-and-Conditions.aspx> and, for electronic format documents, subject to Terms and Conditions for Electronic Documents at <http://www.sgs.com/en/Terms-and-Conditions/Terms-e-Document.aspx>. Attention is drawn to the limitation of liability, indemnification and jurisdiction issues defined therein. Any holder of this document is advised that information contained hereon reflects the Company's findings at the time of its intervention only and within the limits of Client's instructions, if any. The Company's sole responsibility is to its Client and this document does not exonerate parties to a transaction from exercising all their rights and obligations under the transaction documents. This document cannot be reproduced except in full, without prior written approval of the Company. Any unauthorized alteration, forgery or falsification of the content or appearance of this document is unlawful and offenders may be prosecuted to the fullest extent of the law. Unless otherwise stated the results shown in this test report refer only to the sample(s) tested.

Attention: To check the authenticity of testing / inspection report & certificate, please contact us at telephone: (86-755) 8307 1443, or email: [CN\\_Doccheck@sgs.com](mailto:CN_Doccheck@sgs.com)



ATTACHMENTS

Pb/Cd/Hg/Cr<sup>6+</sup> Testing Flow Chart

1) These samples were dissolved totally by pre-conditioning method according to below flow chart. (Cr<sup>6+</sup> test method excluded).

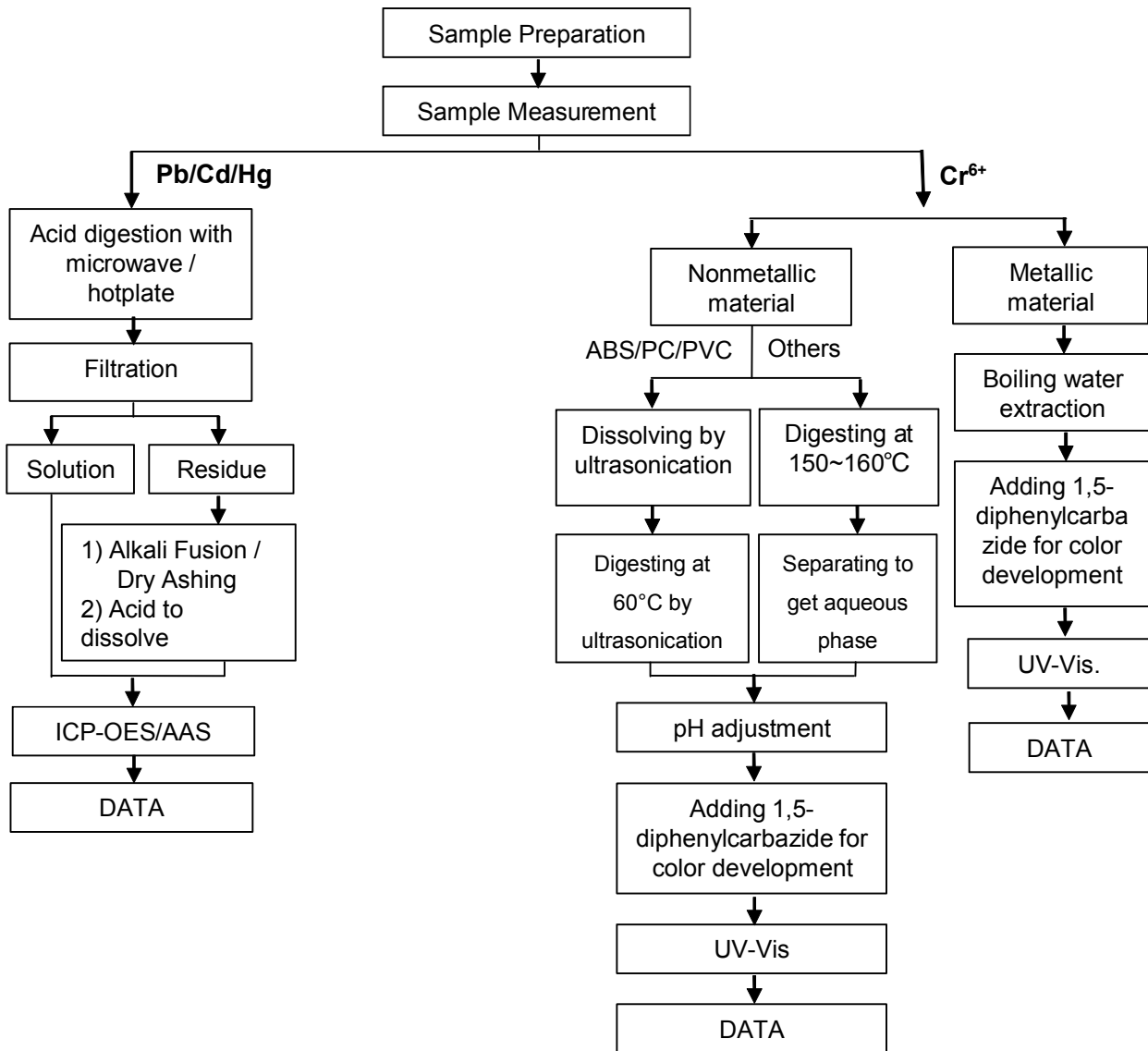

Sample photo:



SGS authenticate the photo on original report only

\*\*\* End of Report \*\*\*



# Test Report

No. CANEC2222380708

Date: 26 Oct 2022

Page 1 of 6

Client Name : SHENZHEN HUALIANWEI ELECTRONICS TECHNOLOGY CO.,LTD

Client Address : 101, 201, PLANT 1, NO.307, GUANLAN GUIHUA ROAD, GUIXIANG COMMUNITY, GUANLAN SUB-DISTRICT, LONGHUA DISTRICT, SHENZHEN CITY, GUANGDONG PROVINCE, CHINA

Sample Name : LCP plastic black color

Model No. : LCP Plastic

Client Ref. Info. : Used for USB series, HDMI series, RJ series, 1394 series, MICRO series, MINI series, DISPLAYPORT series, VGA series, DVI series, TYPE-C series, JACK series

The above sample(s) and information were provided by the client.

SGS Job No. : CP22-057100 - GZ

Date of Sample Received : 20 Oct 2022

Testing Period : 20 Oct 2022 - 26 Oct 2022

Test Requested : Selected test(s) as requested by the client.

Test Method(s) : Please refer to next page(s).

Test Result(s) : Please refer to next page(s).

Result Summary :

Test Requested	Conclusion
EU RoHS Directive (EU) 2015/863 amending Annex II to Directive 2011/65/EU- Lead, Mercury, Cadmium, Hexavalent chromium, Polybrominated biphenyls (PBBs), Polybrominated diphenyl ethers (PBDEs), Bis(2-ethylhexyl) phthalate (DEHP), Butyl benzyl phthalate (BBP), Dibutyl phthalate (DBP) and Diisobutyl phthalate (DIBP)	PASS

Signed for and on behalf of  
SGS-CSTC Standards Technical Services Co., Ltd. Guangzhou Branch

*Dongyu Xie*

Dongyu Xie  
Approved Signatory

scan to see the report



689ECF7B



## Test Report

No. CANEC2222380708

Date: 26 Oct 2022

Page 2 of 6

Test Result(s) :

Test Part Description :

Specimen No.	SGS Sample ID	Description
SN1	CAN22-223807.008	Black plastic

Remarks :

- (1) 1 mg/kg = 0.0001%
- (2) MDL = Method Detection Limit
- (3) ND = Not Detected ( < MDL )
- (4) "-" = Not Regulated

**EU RoHS Directive (EU) 2015/863 amending Annex II to Directive 2011/65/EU- Lead, Mercury, Cadmium, Hexavalent chromium, Polybrominated biphenyls (PBBs), Polybrominated diphenyl ethers (PBDEs), Bis(2-ethylhexyl) phthalate (DEHP), Butyl benzyl phthalate (BBP), Dibutyl phthalate (DBP) and Diisobutyl phthalate (DIBP)**

Test Method : With reference to IEC 62321-4:2013+A1:2017, IEC 62321-5:2013, IEC 62321-7-2:2017 , IEC 62321-6:2015 and IEC 62321-8:2017, analyzed by ICP-OES , UV-Vis and GC-MS .

<u>Test Item(s)</u>	<u>Limit</u>	<u>Unit</u>	<u>MDL</u>	<u>008</u>
Cadmium (Cd)	100	mg/kg	2	ND
Lead (Pb)	1000	mg/kg	2	6
Mercury (Hg)	1000	mg/kg	2	ND
Hexavalent Chromium (CrVI)	1000	mg/kg	8	ND
Sum of PBBs	1000	mg/kg	-	ND
Monobromobiphenyl	-	mg/kg	5	ND
Dibromobiphenyl	-	mg/kg	5	ND
Tribromobiphenyl	-	mg/kg	5	ND
Tetrabromobiphenyl	-	mg/kg	5	ND
Pentabromobiphenyl	-	mg/kg	5	ND
Hexabromobiphenyl	-	mg/kg	5	ND
Heptabromobiphenyl	-	mg/kg	5	ND
Octabromobiphenyl	-	mg/kg	5	ND
Nonabromobiphenyl	-	mg/kg	5	ND
Decabromobiphenyl	-	mg/kg	5	ND
Sum of PBDEs	1000	mg/kg	-	ND
Monobromodiphenyl ether	-	mg/kg	5	ND
Dibromodiphenyl ether	-	mg/kg	5	ND
Tribromodiphenyl ether	-	mg/kg	5	ND
Tetrabromodiphenyl ether	-	mg/kg	5	ND



Unless otherwise agreed in writing, this document is issued by the Company subject to its General Conditions of Service printed overleaf, available on request or accessible at <http://www.sgs.com/en/Terms-and-Conditions.aspx> and, for electronic format documents, subject to Terms and Conditions for Electronic Documents at <http://www.sgs.com/en/Terms-and-Conditions/Terms-e-Documents.aspx>. Attention is drawn to the limitation of liability, indemnification and jurisdiction issues defined therein. Any holder of this document is advised that information contained hereon reflects the Company's findings at the time of its intervention only and within the limits of Client's instructions, if any. The Company's sole responsibility is to its Client and this document does not exonerate parties to a transaction from exercising all their rights and obligations under the transaction documents. This document cannot be reproduced except in full, without prior written approval of the Company. Any unauthorized alteration, forgery or falsification of the content or appearance of this document is unlawful and offenders may be prosecuted to the fullest extent of the law. Unless otherwise stated the results shown in this test report refer only to the sample(s) tested.

Attention: To check the authenticity of testing /inspection report & certificate, please contact us at telephone: (86-755) 8307 1443, or email: [CN.Doccheck@sgs.com](mailto:CN.Doccheck@sgs.com)

# Test Report

No. CANEC2222380708

Date: 26 Oct 2022

Page 3 of 6

<u>Test Item(s)</u>	<u>Limit</u>	<u>Unit</u>	<u>MDL</u>	<u>008</u>
Pentabromodiphenyl ether	-	mg/kg	5	ND
Hexabromodiphenyl ether	-	mg/kg	5	ND
Heptabromodiphenyl ether	-	mg/kg	5	ND
Octabromodiphenyl ether	-	mg/kg	5	ND
Nonabromodiphenyl ether	-	mg/kg	5	ND
Decabromodiphenyl ether	-	mg/kg	5	ND
Dibutyl phthalate (DBP)	1000	mg/kg	50	ND
Butyl benzyl phthalate (BBP)	1000	mg/kg	50	ND
Bis (2-ethylhexyl) phthalate (DEHP)	1000	mg/kg	50	ND
Diisobutyl Phthalates (DIBP)	1000	mg/kg	50	ND

**Notes :**

- (1) The maximum permissible limit is quoted from RoHS Directive (EU) 2015/863.
- (2) IEC 62321 series is equivalent to EN 62321 series
- (3) The restriction of DEHP, BBP, DBP and DIBP shall apply to medical devices, including in vitro medical devices, and monitoring and control instruments, including industrial monitoring and control instruments, from 22 July 2021.

Unless otherwise stated, the decision rule for conformity reporting is based on Binary Statement for Simple Acceptance Rule (  $w=0$  ) stated in ILAC-G8:09/2019.



Unless otherwise agreed in writing, this document is issued by the Company subject to its General Conditions of Service printed overleaf, available on request or accessible at <http://www.sgs.com/en/Terms-and-Conditions.aspx> and, for electronic format documents, subject to Terms and Conditions for Electronic Documents at <http://www.sgs.com/en/Terms-and-Conditions/Terms-e-Documents.aspx>. Attention is drawn to the limitation of liability, indemnification and jurisdiction issues defined therein. Any holder of this document is advised that information contained hereon reflects the Company's findings at the time of its intervention only and within the limits of Client's instructions, if any. The Company's sole responsibility is to its Client and this document does not exonerate parties to a transaction from exercising all their rights and obligations under the transaction documents. This document cannot be reproduced except in full, without prior written approval of the Company. Any unauthorized alteration, forgery or falsification of the content or appearance of this document is unlawful and offenders may be prosecuted to the fullest extent of the law. Unless otherwise stated the results shown in this test report refer only to the sample(s) tested.

**Attention: To check the authenticity of testing /inspection report & certificate, please contact us at telephone: (86-755) 8307 1443, or email: [CN.Doccheck@sgs.com](mailto:CN.Doccheck@sgs.com)**

ATTACHMENTS

**Pb/Cd/Hg/Cr<sup>6+</sup>/PBBs/PBDEs Testing Flow Chart**

1) These samples were dissolved totally by pre-conditioning method according to below flow chart. (Cr<sup>6+</sup> and PBBs/PBDEs test method excluded).

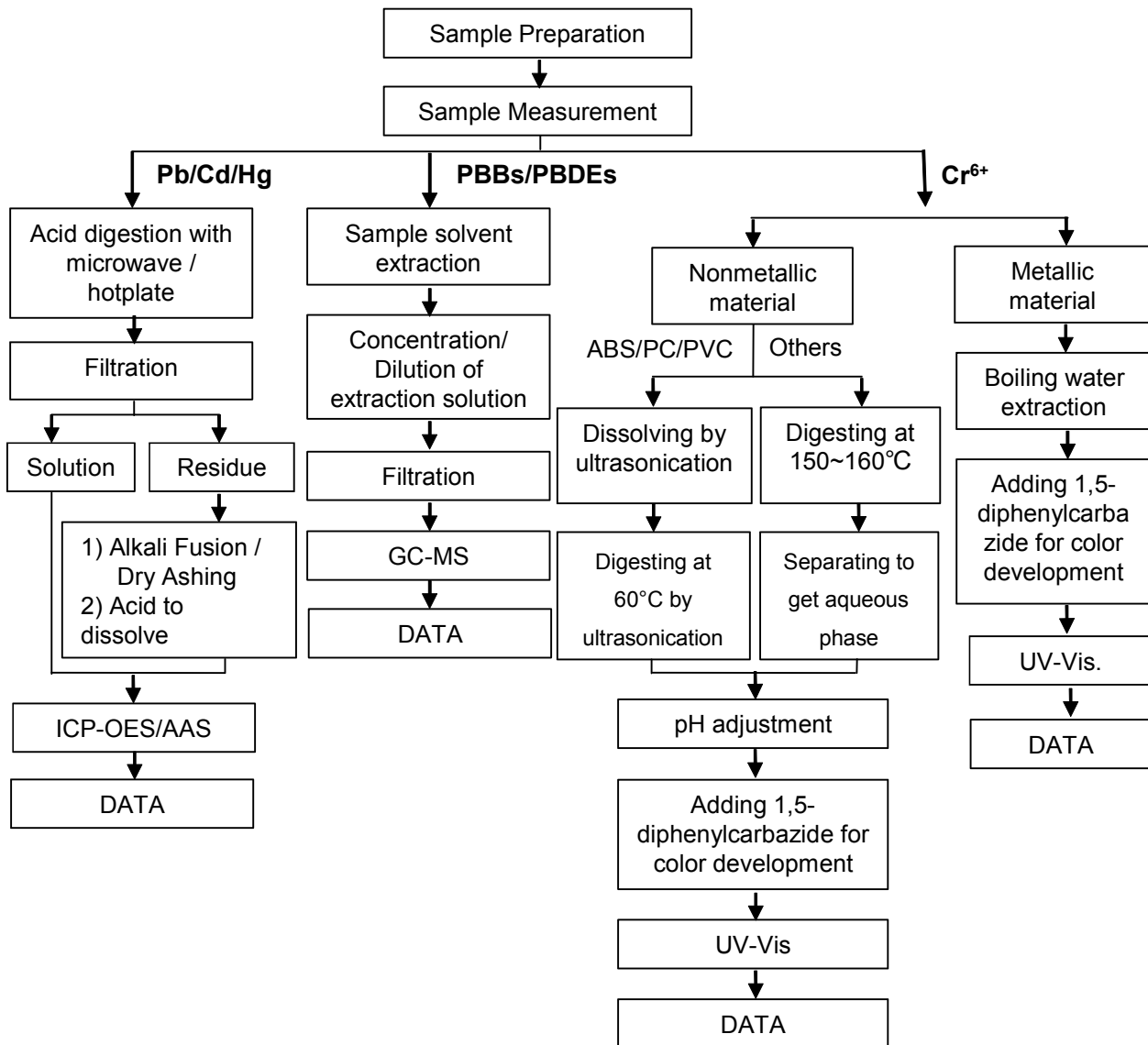

## ATTACHMENTS

### Phthalates Testing Flow Chart

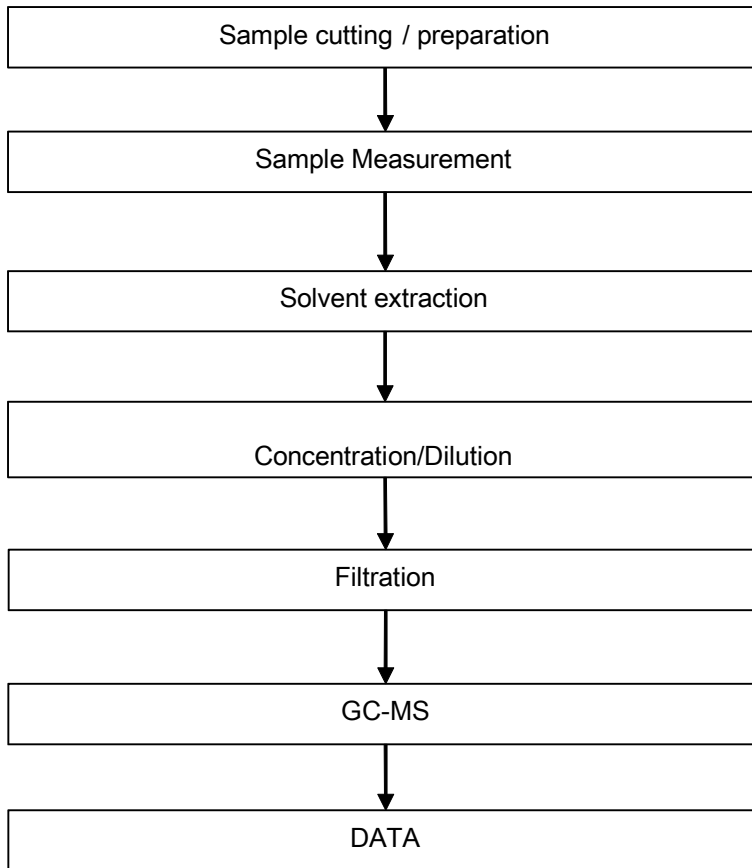

Unless otherwise agreed in writing, this document is issued by the Company subject to its General Conditions of Service printed overleaf, available on request or accessible at <http://www.sgs.com/en/Terms-and-Conditions.aspx> and, for electronic format documents, subject to Terms and Conditions for Electronic Documents at <http://www.sgs.com/en/Terms-and-Conditions/Terms-e-Document.aspx>. Attention is drawn to the limitation of liability, indemnification and jurisdiction issues defined therein. Any holder of this document is advised that information contained hereon reflects the Company's findings at the time of its intervention only and within the limits of Client's instructions, if any. The Company's sole responsibility is to its Client and this document does not exonerate parties to a transaction from exercising all their rights and obligations under the transaction documents. This document cannot be reproduced except in full, without prior written approval of the Company. Any unauthorized alteration, forgery or falsification of the content or appearance of this document is unlawful and offenders may be prosecuted to the fullest extent of the law. Unless otherwise stated the results shown in this test report refer only to the sample(s) tested.

Attention: To check the authenticity of testing / inspection report & certificate, please contact us at telephone: (86-755) 8307 1443, or email: [CN\\_Doccheck@sgs.com](mailto:CN_Doccheck@sgs.com)

Sample photo:



SGS authenticate the photo on original report only

\*\*\* End of Report \*\*\*





## Test Report

No. CANEC2218227001

Date: 30 Aug 2022

Page 1 of 8

Client Name : SHENZHEN CITY TONGHUA INDUSTRY CO.,LTD

Client Address : TONGHUA MANSIN TONGLE XINBU VILLANG TOWN SHENZHEN CITY CHINA

Sample Name : Nickel(Ni)

The above sample(s) and information were provided by the client.

SGS Job No. : CP22-047169 - SZ  
 Date of Sample Received : 25 Aug 2022  
 Testing Period : 25 Aug 2022 - 30 Aug 2022  
 Test Requested : Selected test(s) as requested by the client.  
 Test Method(s) : Please refer to next page(s).  
 Test Result(s) : Please refer to next page(s).

Result Summary :

Test Requested	Conclusion
EU RoHS Directive (EU) 2015/863 amending Annex II to Directive 2011/65/EU- Lead, Mercury, Cadmium, Hexavalent chromium, Polybrominated biphenyls (PBBs), Polybrominated diphenyl ethers (PBDEs), Bis(2-ethylhexyl) phthalate (DEHP), Butyl benzyl phthalate (BBP), Dibutyl phthalate (DBP) and Diisobutyl phthalate (DIBP)	PASS
Perfluorooctanoic acid (PFOA) and its salts & Perfluorooctane sulfonates (PFOS) and its derivatives	See Results

Signed for and on behalf of  
 SGS-CSTC Standards Technical Services Co., Ltd. Guangzhou Branch

*Dongyu Xie*

Dongyu Xie  
 Approved Signatory

scan to see the report



5753937E



Unless otherwise agreed in writing, this document is issued by the Company subject to its General Conditions of Service printed overleaf, available on request or accessible at <http://www.sgs.com/en/Terms-and-Conditions.aspx> and, for electronic format documents, subject to Terms and Conditions for Electronic Documents at <http://www.sgs.com/en/Terms-and-Conditions/Terms-e-Document.aspx>. Attention is drawn to the limitation of liability, indemnification and jurisdiction issues defined therein. Any holder of this document is advised that information contained hereon reflects the Company's findings at the time of its intervention only and within the limits of Client's instructions, if any. The Company's sole responsibility is to its Client and this document does not exonerate parties to a transaction from exercising all their rights and obligations under the transaction documents. This document cannot be reproduced except in full, without prior written approval of the Company. Any unauthorized alteration, forgery or falsification of the content or appearance of this document is unlawful and offenders may be prosecuted to the fullest extent of the law. Unless otherwise stated the results shown in this test report refer only to the sample(s) tested.

Attention: To check the authenticity of testing /inspection report & certificate, please contact us at telephone: (86-755) 8307 1443, or email: [CN.Doccheck@sgs.com](mailto:CN.Doccheck@sgs.com)

## Test Report

No. CANEC2218227001

Date: 30 Aug 2022

Page 2 of 8

Test Result(s) :

### Test Part Description :

Specimen No.	SGS Sample ID	Description
SN1	CAN22-182270.001	Silver-gray plated metal

Remarks :

- (1) 1 mg/kg = 0.0001%
- (2) MDL = Method Detection Limit
- (3) ND = Not Detected ( < MDL )
- (4) "-" = Not Regulated

**EU RoHS Directive (EU) 2015/863 amending Annex II to Directive 2011/65/EU- Lead, Mercury, Cadmium, Hexavalent chromium, Polybrominated biphenyls (PBBs), Polybrominated diphenyl ethers (PBDEs), Bis(2-ethylhexyl) phthalate (DEHP), Butyl benzyl phthalate (BBP), Dibutyl phthalate (DBP) and Diisobutyl phthalate (DIBP)**

Test Method : With reference to IEC 62321-4:2013+A1:2017, IEC 62321-5:2013, IEC 62321-7-1:2015 , IEC 62321-6:2015 and IEC 62321-8:2017, analyzed by ICP-OES , UV-Vis and GC-MS .

Test Item(s)	Limit	Unit	MDL	001
Cadmium (Cd)	100	mg/kg	2	ND
Lead (Pb)	1000	mg/kg	2	49
Mercury (Hg)	1000	mg/kg	2	ND
Hexavalent Chromium (Cr(VI))▼	-	µg/cm <sup>2</sup>	0.10	ND
Sum of PBBs	1000	mg/kg	-	ND
Monobromobiphenyl	-	mg/kg	5	ND
Dibromobiphenyl	-	mg/kg	5	ND
Tribromobiphenyl	-	mg/kg	5	ND
Tetrabromobiphenyl	-	mg/kg	5	ND
Pentabromobiphenyl	-	mg/kg	5	ND
Hexabromobiphenyl	-	mg/kg	5	ND
Heptabromobiphenyl	-	mg/kg	5	ND
Octabromobiphenyl	-	mg/kg	5	ND
Nonabromobiphenyl	-	mg/kg	5	ND
Decabromobiphenyl	-	mg/kg	5	ND
Sum of PBDEs	1000	mg/kg	-	ND
Monobromodiphenyl ether	-	mg/kg	5	ND
Dibromodiphenyl ether	-	mg/kg	5	ND
Tribromodiphenyl ether	-	mg/kg	5	ND
Tetrabromodiphenyl ether	-	mg/kg	5	ND



Unless otherwise agreed in writing, this document is issued by the Company subject to its General Conditions of Service printed overleaf, available on request or accessible at <http://www.sgs.com/en/Terms-and-Conditions.aspx> and, for electronic format documents, subject to Terms and Conditions for Electronic Documents at <http://www.sgs.com/en/Terms-and-Conditions/Terms-e-Documents.aspx>. Attention is drawn to the limitation of liability, indemnification and jurisdiction issues defined therein. Any holder of this document is advised that information contained hereon reflects the Company's findings at the time of its intervention only and within the limits of Client's instructions, if any. The Company's sole responsibility is to its Client and this document does not exonerate parties to a transaction from exercising all their rights and obligations under the transaction documents. This document cannot be reproduced except in full, without prior written approval of the Company. Any unauthorized alteration, forgery or falsification of the content or appearance of this document is unlawful and offenders may be prosecuted to the fullest extent of the law. Unless otherwise stated the results shown in this test report refer only to the sample(s) tested.

Attention: To check the authenticity of testing / inspection report & certificate, please contact us at telephone: (86-755) 8307 1443, or email: [CN.Doccheck@sgs.com](mailto:CN.Doccheck@sgs.com)

## Test Report

No. CANEC2218227001

Date: 30 Aug 2022

Page 3 of 8

<u>Test Item(s)</u>	<u>Limit</u>	<u>Unit</u>	<u>MDL</u>	<u>001</u>
Pentabromodiphenyl ether	-	mg/kg	5	ND
Hexabromodiphenyl ether	-	mg/kg	5	ND
Heptabromodiphenyl ether	-	mg/kg	5	ND
Octabromodiphenyl ether	-	mg/kg	5	ND
Nonabromodiphenyl ether	-	mg/kg	5	ND
Decabromodiphenyl ether	-	mg/kg	5	ND
Dibutyl phthalate (DBP)	1000	mg/kg	50	ND
Butyl benzyl phthalate (BBP)	1000	mg/kg	50	ND
Bis (2-ethylhexyl) phthalate (DEHP)	1000	mg/kg	50	ND
Diisobutyl Phthalates (DIBP)	1000	mg/kg	50	ND

### Notes :

- (1) The maximum permissible limit is quoted from RoHS Directive (EU) 2015/863.
- (2) IEC 62321 series is equivalent to EN 62321 series
- (3) ▼= a. The sample is positive for CrVI if the CrVI concentration is greater than 0.13  $\mu\text{g}/\text{cm}^2$ . The sample coating is considered to contain CrVI  
 b. The sample is negative for CrVI if CrVI is ND (concentration less than 0.10  $\mu\text{g}/\text{cm}^2$ ). The coating is considered a non-CrVI based coating  
 c. The result between 0.10  $\mu\text{g}/\text{cm}^2$  and 0.13  $\mu\text{g}/\text{cm}^2$  is considered to be inconclusive - unavoidable coating variations may influence the determination  
 Information on storage conditions and production date of the tested sample is unavailable and thus Cr(VI) results represent status of the sample at the time of testing.

### Perfluorooctanoic acid (PFOA) and its salts & Perfluorooctane sulfonates (PFOS) and its derivatives

Test Method : With reference to CEN/TS15968:2010, analysis was performed by LC-MS or LC-MS/MS.

<u>Test Item(s)</u>	<u>CAS NO.</u>	<u>Unit</u>	<u>MDL</u>	<u>001</u>
Perfluorooctanoic acid (PFOA) and its salts+	335-67-1	mg/kg	0.010	ND
Perfluorooctane sulfonates (PFOS) ^	1763-23-1	mg/kg	0.010	ND
Perfluorooctane Sulfonamide (PFOSA)	754-91-6	mg/kg	0.010	ND
N-methylperfluoro-1-octanesulfonamide(MeFOSA)	31506-32-8	mg/kg	0.010	ND
N-ethylperfluoro-1-octanesulfonamide (EtFOSA)	4151-50-2	mg/kg	0.010	ND
2-(N-methylperfluoro-1-octanesulfonamido)-ethanol(MeFOSE)	24448-09-7	mg/kg	0.010	ND
2-(N-ethylperfluoro-1-octanesulfonamido)-ethanol(EtFOSE)	1691-99-2	mg/kg	0.010	ND
Perfluorooctane sulfonates (PFOS) and its derivatives	-	mg/kg	-	ND

### Notes :



Unless otherwise agreed in writing, this document is issued by the Company subject to its General Conditions of Service printed overleaf, available on request or accessible at <http://www.sgs.com/en/Terms-and-Conditions.aspx> and, for electronic format documents, subject to Terms and Conditions for Electronic Documents at <http://www.sgs.com/en/Terms-and-Conditions/Terms-e-Document.aspx>. Attention is drawn to the limitation of liability, indemnification and jurisdiction issues defined therein. Any holder of this document is advised that information contained hereon reflects the Company's findings at the time of its intervention only and within the limits of Client's instructions, if any. The Company's sole responsibility is to its Client and this document does not exonerate parties to a transaction from exercising all their rights and obligations under the transaction documents. This document cannot be reproduced except in full, without prior written approval of the Company. Any unauthorized alteration, forgery or falsification of the content or appearance of this document is unlawful and offenders may be prosecuted to the fullest extent of the law. Unless otherwise stated the results shown in this test report refer only to the sample(s) tested.

Attention: To check the authenticity of testing /inspection report & certificate, please contact us at telephone: (86-755) 8307 1443, or email: [CN.Doccheck@sgs.com](mailto:CN.Doccheck@sgs.com)

- (1) + PFOA and its salts including PFOA-Na (CAS No.: 335-95-5), PFOA-K (CAS No.: 2395-00-8), PFOA-Ag (CAS No.: 335-93-3), PFOA-F (CAS No.: 335-66-0) and APFO (CAS No.: 3825-26-1);
- (2) ^ PFOS including PFOS-K (CAS No.: 2795-39-3), PFOS-Li (CAS No.: 29457-72-5), PFOS-NH<sub>4</sub> (CAS No.: 29081-56-9), PFOS-NH(OH)<sub>2</sub> (CAS No.: 70225-14-8), PFOS-N(C<sub>2</sub>H<sub>5</sub>)<sub>4</sub> (CAS No.: 56773-42-3), PFOS-DDA (CAS No.: 251099-16-8) and POSF (CAS No.: 307-35-7)

Unless otherwise stated, the decision rule for conformity reporting is based on Binary Statement for Simple Acceptance Rule ( $w=0$ ) stated in ILAC-G8:09/2019.



Unless otherwise agreed in writing, this document is issued by the Company subject to its General Conditions of Service printed overleaf, available on request or accessible at <http://www.sgs.com/en/Terms-and-Conditions.aspx> and, for electronic format documents, subject to Terms and Conditions for Electronic Documents at <http://www.sgs.com/en/Terms-and-Conditions/Terms-e-Documents.aspx>. Attention is drawn to the limitation of liability, indemnification and jurisdiction issues defined therein. Any holder of this document is advised that information contained hereon reflects the Company's findings at the time of its intervention only and within the limits of Client's instructions, if any. The Company's sole responsibility is to its Client and this document does not exonerate parties to a transaction from exercising all their rights and obligations under the transaction documents. This document cannot be reproduced except in full, without prior written approval of the Company. Any unauthorized alteration, forgery or falsification of the content or appearance of this document is unlawful and offenders may be prosecuted to the fullest extent of the law. Unless otherwise stated the results shown in this test report refer only to the sample(s) tested.

Attention: To check the authenticity of testing / inspection report & certificate, please contact us at telephone: (86-755) 8307 1443, or email: [CN.Doccheck@sgs.com](mailto:CN.Doccheck@sgs.com)

ATTACHMENTS

**Pb/Cd/Hg/Cr<sup>6+</sup>/PBBs/PBDEs Testing Flow Chart**

1) These samples were dissolved totally by pre-conditioning method according to below flow chart. (Cr<sup>6+</sup> and PBBs/PBDEs test method excluded).

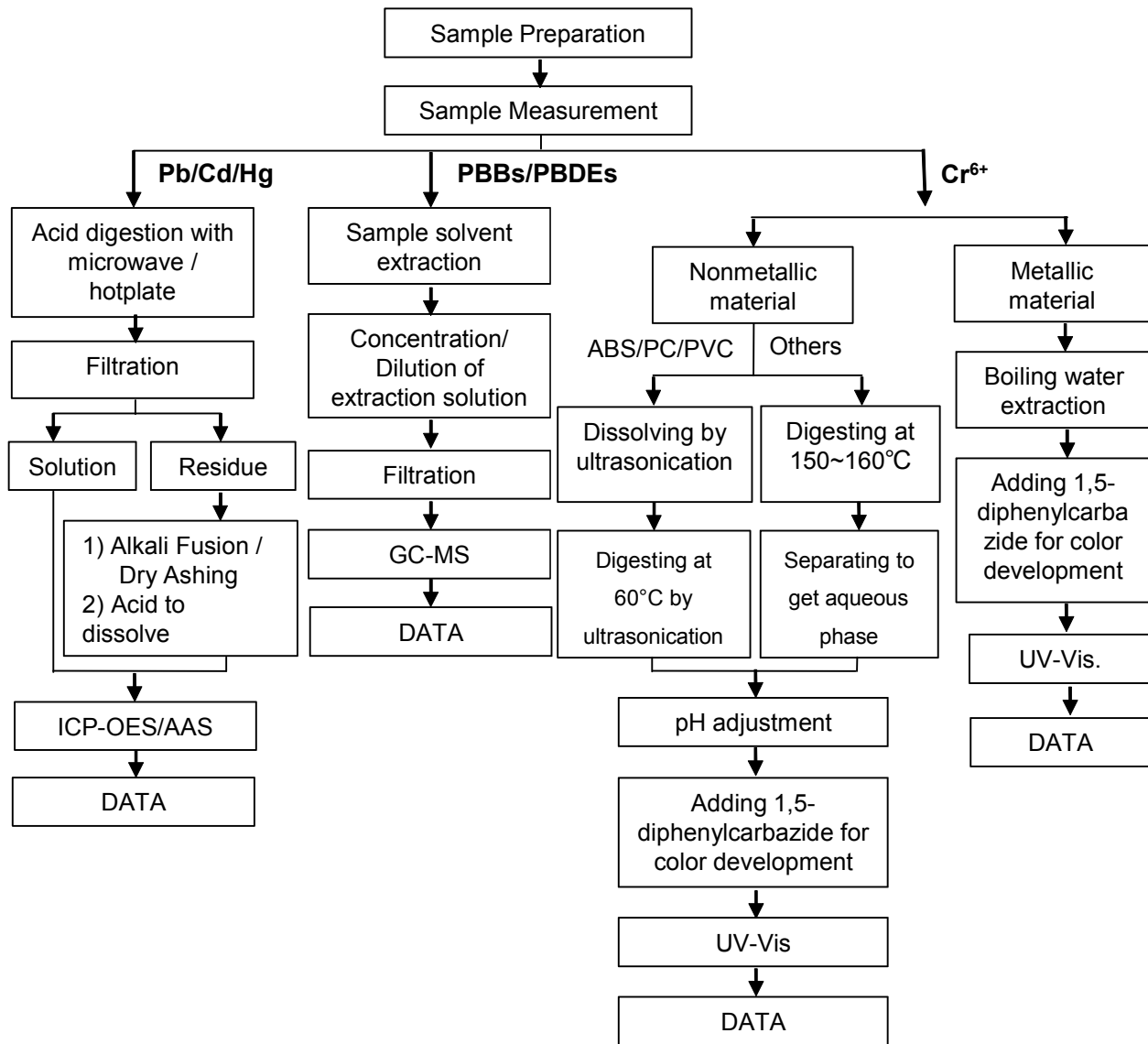

ATTACHMENTS

Phthalates Testing Flow Chart

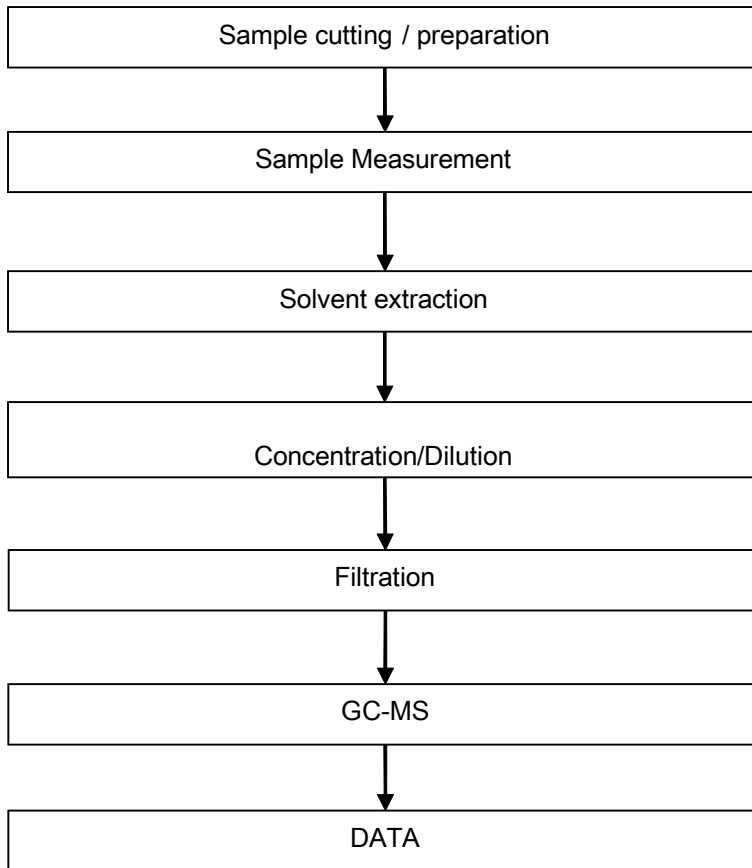

Unless otherwise agreed in writing, this document is issued by the Company subject to its General Conditions of Service printed overleaf, available on request or accessible at <http://www.sgs.com/en/Terms-and-Conditions.aspx> and, for electronic format documents, subject to Terms and Conditions for Electronic Documents at <http://www.sgs.com/en/Terms-and-Conditions/Terms-e-Document.aspx>. Attention is drawn to the limitation of liability, indemnification and jurisdiction issues defined therein. Any holder of this document is advised that information contained hereon reflects the Company's findings at the time of its intervention only and within the limits of Client's instructions, if any. The Company's sole responsibility is to its Client and this document does not exonerate parties to a transaction from exercising all their rights and obligations under the transaction documents. This document cannot be reproduced except in full, without prior written approval of the Company. Any unauthorized alteration, forgery or falsification of the content or appearance of this document is unlawful and offenders may be prosecuted to the fullest extent of the law. Unless otherwise stated the results shown in this test report refer only to the sample(s) tested.

Attention: To check the authenticity of testing / inspection report & certificate, please contact us at telephone: (86-755) 8307 1443, or email: [CN\\_Doccheck@sgs.com](mailto:CN_Doccheck@sgs.com)

ATTACHMENTS

PFOA / PFOS Testing Flow Chart

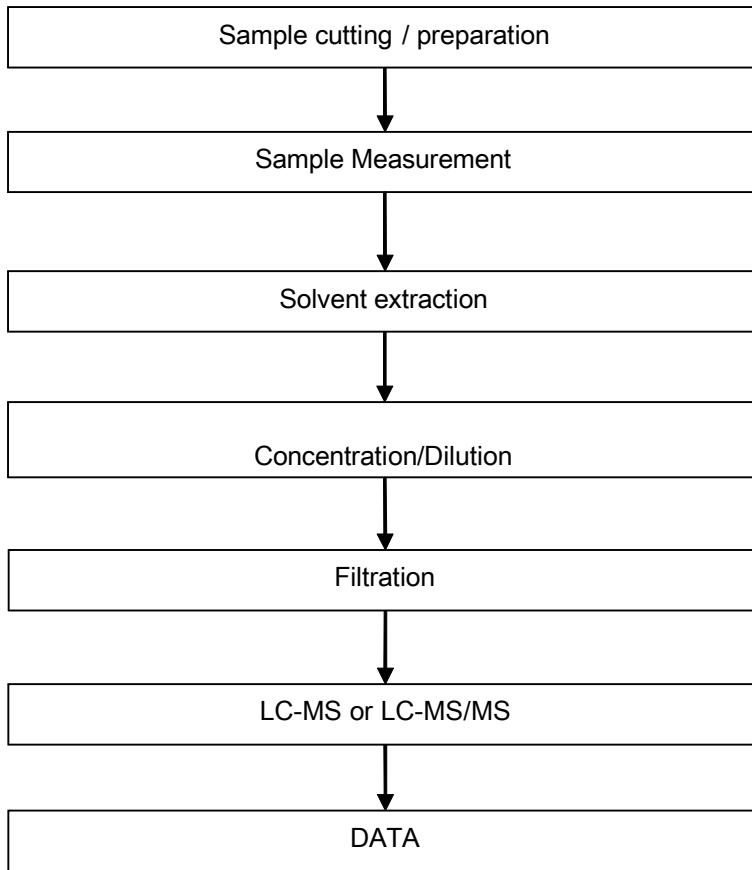

Unless otherwise agreed in writing, this document is issued by the Company subject to its General Conditions of Service printed overleaf, available on request or accessible at <http://www.sgs.com/en/Terms-and-Conditions.aspx> and, for electronic format documents, subject to Terms and Conditions for Electronic Documents at <http://www.sgs.com/en/Terms-and-Conditions/Terms-e-Document.aspx>. Attention is drawn to the limitation of liability, indemnification and jurisdiction issues defined therein. Any holder of this document is advised that information contained hereon reflects the Company's findings at the time of its intervention only and within the limits of Client's instructions, if any. The Company's sole responsibility is to its Client and this document does not exonerate parties to a transaction from exercising all their rights and obligations under the transaction documents. This document cannot be reproduced except in full, without prior written approval of the Company. Any unauthorized alteration, forgery or falsification of the content or appearance of this document is unlawful and offenders may be prosecuted to the fullest extent of the law. Unless otherwise stated the results shown in this test report refer only to the sample(s) tested.

Attention: To check the authenticity of testing / inspection report & certificate, please contact us at telephone: (86-755) 8307 1443, or email: [CN\\_Doccheck@sgs.com](mailto:CN_Doccheck@sgs.com)

Sample photo:



SGS authenticate the photo on original report only

\*\*\* End of Report \*\*\*





# Test Report

No. CANEC2218227003

Date: 30 Aug 2022

Page 1 of 8

Client Name : SHENZHEN CITY TONGHUA INDUSTRY CO.,LTD

Client Address : TONGHUA MANSIN TONGLE XINBU VILLANG TOWN SHENZHEN CITY CHINA

Sample Name : Bright Tin(SN)

The above sample(s) and information were provided by the client.

SGS Job No. : CP22-047169 - SZ  
 Date of Sample Received : 25 Aug 2022  
 Testing Period : 25 Aug 2022 - 30 Aug 2022  
 Test Requested : Selected test(s) as requested by the client.  
 Test Method(s) : Please refer to next page(s).  
 Test Result(s) : Please refer to next page(s).

Result Summary :

Test Requested	Conclusion
EU RoHS Directive (EU) 2015/863 amending Annex II to Directive 2011/65/EU- Lead, Mercury, Cadmium, Hexavalent chromium, Polybrominated biphenyls (PBBs), Polybrominated diphenyl ethers (PBDEs), Bis(2-ethylhexyl) phthalate (DEHP), Butyl benzyl phthalate (BBP), Dibutyl phthalate (DBP) and Diisobutyl phthalate (DIBP)	PASS
Perfluorooctanoic acid (PFOA) and its salts & Perfluorooctane sulfonates (PFOS) and its derivatives	See Results

Signed for and on behalf of  
 SGS-CSTC Standards Technical Services Co., Ltd. Guangzhou Branch

*Dongyu Xie*

Dongyu Xie  
 Approved Signatory

scan to see the report



87F8007D



Unless otherwise agreed in writing, this document is issued by the Company subject to its General Conditions of Service printed overleaf, available on request or accessible at <http://www.sgs.com/en/Terms-and-Conditions.aspx> and, for electronic format documents, subject to Terms and Conditions for Electronic Documents at <http://www.sgs.com/en/Terms-and-Conditions/Terms-e-Document.aspx>. Attention is drawn to the limitation of liability, indemnification and jurisdiction issues defined therein. Any holder of this document is advised that information contained hereon reflects the Company's findings at the time of its intervention only and within the limits of Client's instructions, if any. The Company's sole responsibility is to its Client and this document does not exonerate parties to a transaction from exercising all their rights and obligations under the transaction documents. This document cannot be reproduced except in full, without prior written approval of the Company. Any unauthorized alteration, forgery or falsification of the content or appearance of this document is unlawful and offenders may be prosecuted to the fullest extent of the law. Unless otherwise stated the results shown in this test report refer only to the sample(s) tested.

Attention: To check the authenticity of testing /inspection report & certificate, please contact us at telephone: (86-755) 8307 1443, or email: [CN.Doccheck@sgs.com](mailto:CN.Doccheck@sgs.com)

## Test Report

No. CANEC2218227003

Date: 30 Aug 2022

Page 2 of 8

Test Result(s) :

### Test Part Description :

Specimen No.	SGS Sample ID	Description
SN1	CAN22-182270.003	Silver-gray plated metal

Remarks :

- (1) 1 mg/kg = 0.0001%
- (2) MDL = Method Detection Limit
- (3) ND = Not Detected ( < MDL )
- (4) "-" = Not Regulated

**EU RoHS Directive (EU) 2015/863 amending Annex II to Directive 2011/65/EU- Lead, Mercury, Cadmium, Hexavalent chromium, Polybrominated biphenyls (PBBs), Polybrominated diphenyl ethers (PBDEs), Bis(2-ethylhexyl) phthalate (DEHP), Butyl benzyl phthalate (BBP), Dibutyl phthalate (DBP) and Diisobutyl phthalate (DIBP)**

Test Method : With reference to IEC 62321-4:2013+A1:2017, IEC 62321-5:2013, IEC 62321-7-1:2015 , IEC 62321-6:2015 and IEC 62321-8:2017, analyzed by ICP-OES , UV-Vis and GC-MS .

Test Item(s)	Limit	Unit	MDL	003
Cadmium (Cd)	100	mg/kg	2	ND
Lead (Pb)	1000	mg/kg	2	44
Mercury (Hg)	1000	mg/kg	2	ND
Hexavalent Chromium (Cr(VI))▼	-	µg/cm <sup>2</sup>	0.10	ND
Sum of PBBs	1000	mg/kg	-	ND
Monobromobiphenyl	-	mg/kg	5	ND
Dibromobiphenyl	-	mg/kg	5	ND
Tribromobiphenyl	-	mg/kg	5	ND
Tetrabromobiphenyl	-	mg/kg	5	ND
Pentabromobiphenyl	-	mg/kg	5	ND
Hexabromobiphenyl	-	mg/kg	5	ND
Heptabromobiphenyl	-	mg/kg	5	ND
Octabromobiphenyl	-	mg/kg	5	ND
Nonabromobiphenyl	-	mg/kg	5	ND
Decabromobiphenyl	-	mg/kg	5	ND
Sum of PBDEs	1000	mg/kg	-	ND
Monobromodiphenyl ether	-	mg/kg	5	ND
Dibromodiphenyl ether	-	mg/kg	5	ND
Tribromodiphenyl ether	-	mg/kg	5	ND
Tetrabromodiphenyl ether	-	mg/kg	5	ND



Unless otherwise agreed in writing, this document is issued by the Company subject to its General Conditions of Service printed overleaf, available on request or accessible at <http://www.sgs.com/en/Terms-and-Conditions.aspx> and, for electronic format documents, subject to Terms and Conditions for Electronic Documents at <http://www.sgs.com/en/Terms-and-Conditions/Terms-e-Documents.aspx>. Attention is drawn to the limitation of liability, indemnification and jurisdiction issues defined therein. Any holder of this document is advised that information contained hereon reflects the Company's findings at the time of its intervention only and within the limits of Client's instructions, if any. The Company's sole responsibility is to its Client and this document does not exonerate parties to a transaction from exercising all their rights and obligations under the transaction documents. This document cannot be reproduced except in full, without prior written approval of the Company. Any unauthorized alteration, forgery or falsification of the content or appearance of this document is unlawful and offenders may be prosecuted to the fullest extent of the law. Unless otherwise stated the results shown in this test report refer only to the sample(s) tested.

Attention: To check the authenticity of testing /inspection report & certificate, please contact us at telephone: (86-755) 8307 1443, or email: [CN.Doccheck@sgs.com](mailto:CN.Doccheck@sgs.com)

# Test Report

No. CANEC2218227003

Date: 30 Aug 2022

Page 3 of 8

<u>Test Item(s)</u>	<u>Limit</u>	<u>Unit</u>	<u>MDL</u>	<u>003</u>
Pentabromodiphenyl ether	-	mg/kg	5	ND
Hexabromodiphenyl ether	-	mg/kg	5	ND
Heptabromodiphenyl ether	-	mg/kg	5	ND
Octabromodiphenyl ether	-	mg/kg	5	ND
Nonabromodiphenyl ether	-	mg/kg	5	ND
Decabromodiphenyl ether	-	mg/kg	5	ND
Dibutyl phthalate (DBP)	1000	mg/kg	50	ND
Butyl benzyl phthalate (BBP)	1000	mg/kg	50	ND
Bis (2-ethylhexyl) phthalate (DEHP)	1000	mg/kg	50	ND
Diisobutyl Phthalates (DIBP)	1000	mg/kg	50	ND

**Notes :**

- (1) The maximum permissible limit is quoted from RoHS Directive (EU) 2015/863.
  - (2) IEC 62321 series is equivalent to EN 62321 series
  - (3) ▼= a. The sample is positive for CrVI if the CrVI concentration is greater than 0.13 µg/cm<sup>2</sup>. The sample coating is considered to contain CrVI
    - b. The sample is negative for CrVI if CrVI is ND (concentration less than 0.10 µg/cm<sup>2</sup>). The coating is considered a non-CrVI based coating
    - c. The result between 0.10 µg/cm<sup>2</sup> and 0.13 µg/cm<sup>2</sup> is considered to be inconclusive - unavoidable coating variations may influence the determination
- Information on storage conditions and production date of the tested sample is unavailable and thus Cr(VI) results represent status of the sample at the time of testing.

**Perfluorooctanoic acid (PFOA) and its salts & Perfluorooctane sulfonates (PFOS) and its derivatives**

Test Method : With reference to CEN/TS15968:2010, analysis was performed by LC-MS or LC-MS/MS.

<u>Test Item(s)</u>	<u>CAS NO.</u>	<u>Unit</u>	<u>MDL</u>	<u>003</u>
Perfluorooctanoic acid (PFOA) and its salts+	335-67-1	mg/kg	0.010	ND
Perfluorooctane sulfonates (PFOS) ^	1763-23-1	mg/kg	0.010	ND
Perfluorooctane Sulfonamide (PFOSA)	754-91-6	mg/kg	0.010	ND
N-methylperfluoro-1-octanesulfonamide(MeFOSA)	31506-32-8	mg/kg	0.010	ND
N-ethylperfluoro-1-octanesulfonamide (EtFOSA)	4151-50-2	mg/kg	0.010	ND
2-(N-methylperfluoro-1-octanesulfonamido)-ethanol(MeFOSE)	24448-09-7	mg/kg	0.010	ND
2-(N-ethylperfluoro-1-octanesulfonamido)-ethanol(EtFOSE)	1691-99-2	mg/kg	0.010	ND
Perfluorooctane sulfonates (PFOS) and its derivatives	-	mg/kg	-	ND

**Notes :**



Unless otherwise agreed in writing, this document is issued by the Company subject to its General Conditions of Service printed overleaf, available on request or accessible at <http://www.sgs.com/en/Terms-and-Conditions.aspx> and, for electronic format documents, subject to Terms and Conditions for Electronic Documents at <http://www.sgs.com/en/Terms-and-Conditions/Terms-e-Documents.aspx>. Attention is drawn to the limitation of liability, indemnification and jurisdiction issues defined therein. Any holder of this document is advised that information contained hereon reflects the Company's findings at the time of its intervention only and within the limits of Client's instructions, if any. The Company's sole responsibility is to its Client and this document does not exonerate parties to a transaction from exercising all their rights and obligations under the transaction documents. This document cannot be reproduced except in full, without prior written approval of the Company. Any unauthorized alteration, forgery or falsification of the content or appearance of this document is unlawful and offenders may be prosecuted to the fullest extent of the law. Unless otherwise stated the results shown in this test report refer only to the sample(s) tested.

- (1) + PFOA and its salts including PFOA-Na (CAS No.: 335-95-5), PFOA-K (CAS No.: 2395-00-8), PFOA-Ag (CAS No.: 335-93-3), PFOA-F (CAS No.: 335-66-0) and APFO (CAS No.: 3825-26-1);
- (2) ^ PFOS including PFOS-K (CAS No.: 2795-39-3), PFOS-Li (CAS No.: 29457-72-5), PFOS-NH<sub>4</sub> (CAS No.: 29081-56-9), PFOS-NH(OH)<sub>2</sub> (CAS No.: 70225-14-8), PFOS-N(C<sub>2</sub>H<sub>5</sub>)<sub>4</sub> (CAS No.: 56773-42-3), PFOS-DDA(CAS No.:251099-16-8) and POSF (CAS No.: 307-35-7)

Unless otherwise stated, the decision rule for conformity reporting is based on Binary Statement for Simple Acceptance Rule ( $w=0$ ) stated in ILAC-G8:09/2019.



Unless otherwise agreed in writing, this document is issued by the Company subject to its General Conditions of Service printed overleaf, available on request or accessible at <http://www.sgs.com/en/Terms-and-Conditions.aspx> and, for electronic format documents, subject to Terms and Conditions for Electronic Documents at <http://www.sgs.com/en/Terms-and-Conditions/Terms-e-Documents.aspx>. Attention is drawn to the limitation of liability, indemnification and jurisdiction issues defined therein. Any holder of this document is advised that information contained hereon reflects the Company's findings at the time of its intervention only and within the limits of Client's instructions, if any. The Company's sole responsibility is to its Client and this document does not exonerate parties to a transaction from exercising all their rights and obligations under the transaction documents. This document cannot be reproduced except in full, without prior written approval of the Company. Any unauthorized alteration, forgery or falsification of the content or appearance of this document is unlawful and offenders may be prosecuted to the fullest extent of the law. Unless otherwise stated the results shown in this test report refer only to the sample(s) tested.

Attention: To check the authenticity of testing / inspection report & certificate, please contact us at telephone: (86-755) 8307 1443, or email: [CN.Doccheck@sgs.com](mailto:CN.Doccheck@sgs.com)

ATTACHMENTS

Pb/Cd/Hg/Cr<sup>6+</sup>/PBBs/PBDEs Testing Flow Chart

1) These samples were dissolved totally by pre-conditioning method according to below flow chart. (Cr<sup>6+</sup> and PBBs/PBDEs test method excluded).

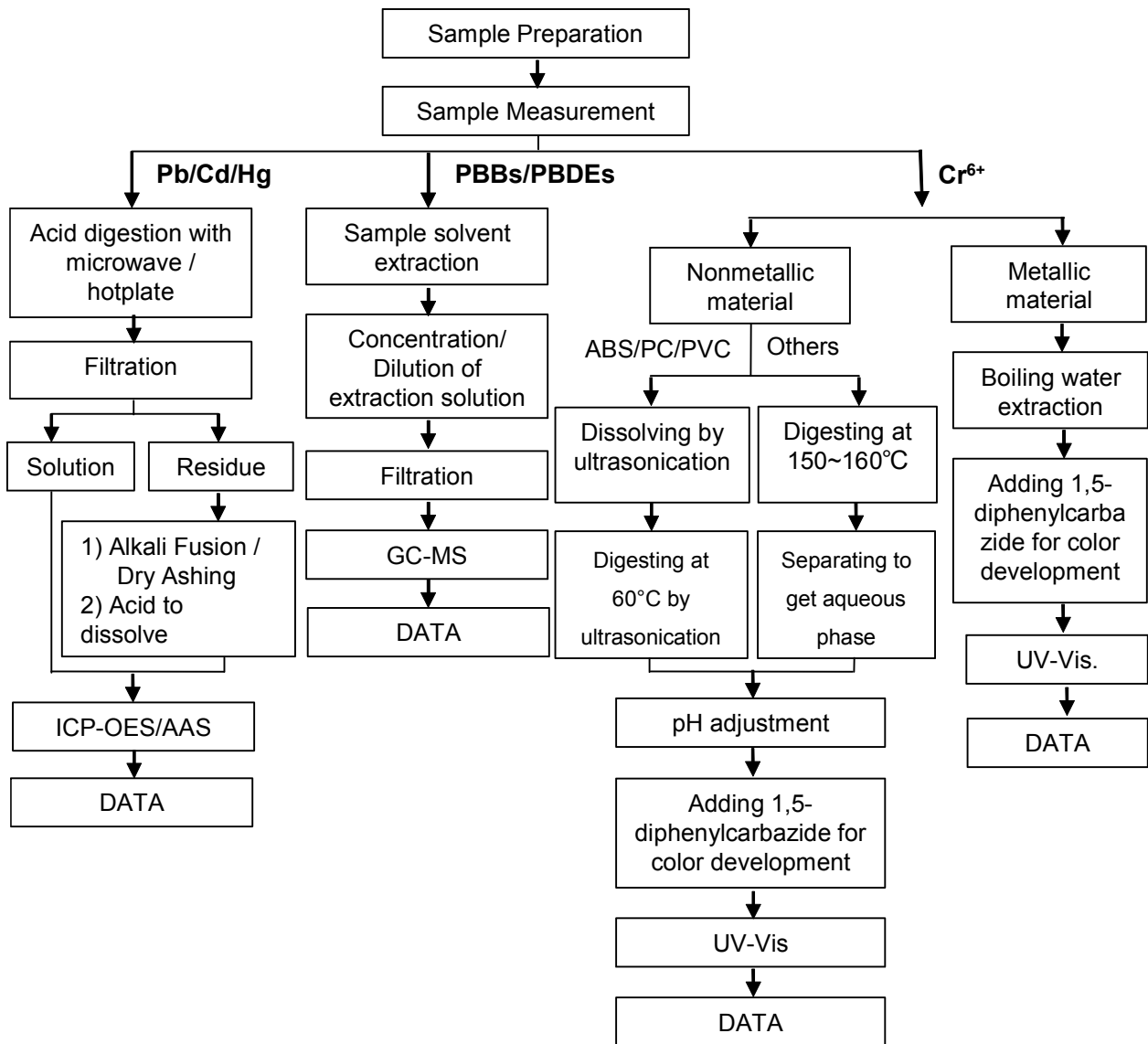

ATTACHMENTS

Phthalates Testing Flow Chart

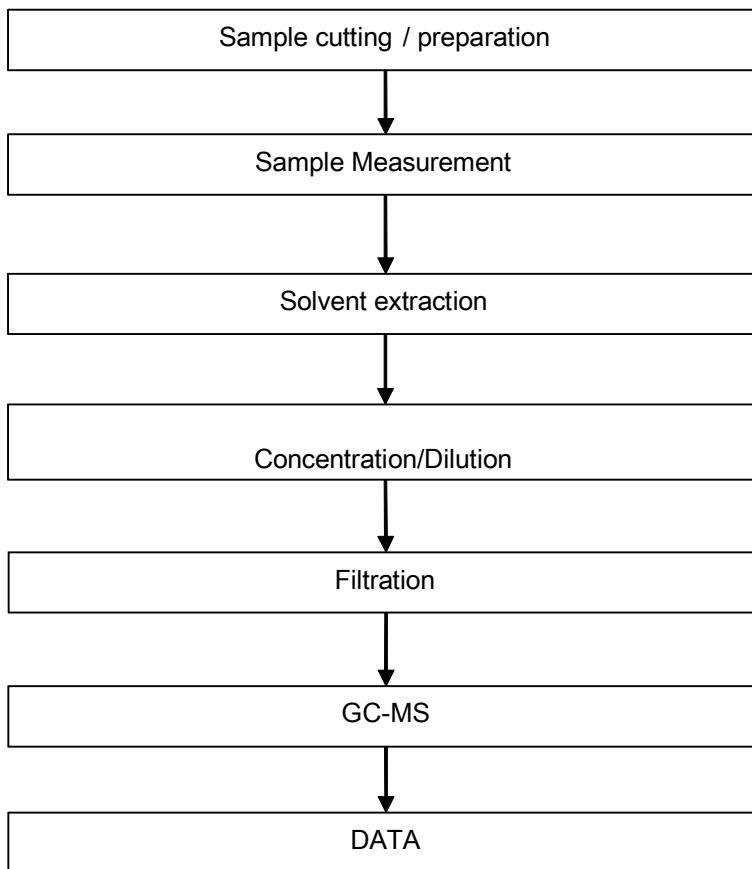

Unless otherwise agreed in writing, this document is issued by the Company subject to its General Conditions of Service printed overleaf, available on request or accessible at <http://www.sgs.com/en/Terms-and-Conditions.aspx> and, for electronic format documents, subject to Terms and Conditions for Electronic Documents at <http://www.sgs.com/en/Terms-and-Conditions/Terms-e-Document.aspx>. Attention is drawn to the limitation of liability, indemnification and jurisdiction issues defined therein. Any holder of this document is advised that information contained hereon reflects the Company's findings at the time of its intervention only and within the limits of Client's instructions, if any. The Company's sole responsibility is to its Client and this document does not exonerate parties to a transaction from exercising all their rights and obligations under the transaction documents. This document cannot be reproduced except in full, without prior written approval of the Company. Any unauthorized alteration, forgery or falsification of the content or appearance of this document is unlawful and offenders may be prosecuted to the fullest extent of the law. Unless otherwise stated the results shown in this test report refer only to the sample(s) tested.

Attention: To check the authenticity of testing / inspection report & certificate, please contact us at telephone: (86-755) 8307 1443, or email: [CN\\_Doccheck@sgs.com](mailto:CN_Doccheck@sgs.com)

## ATTACHMENTS

### PFOA / PFOS Testing Flow Chart

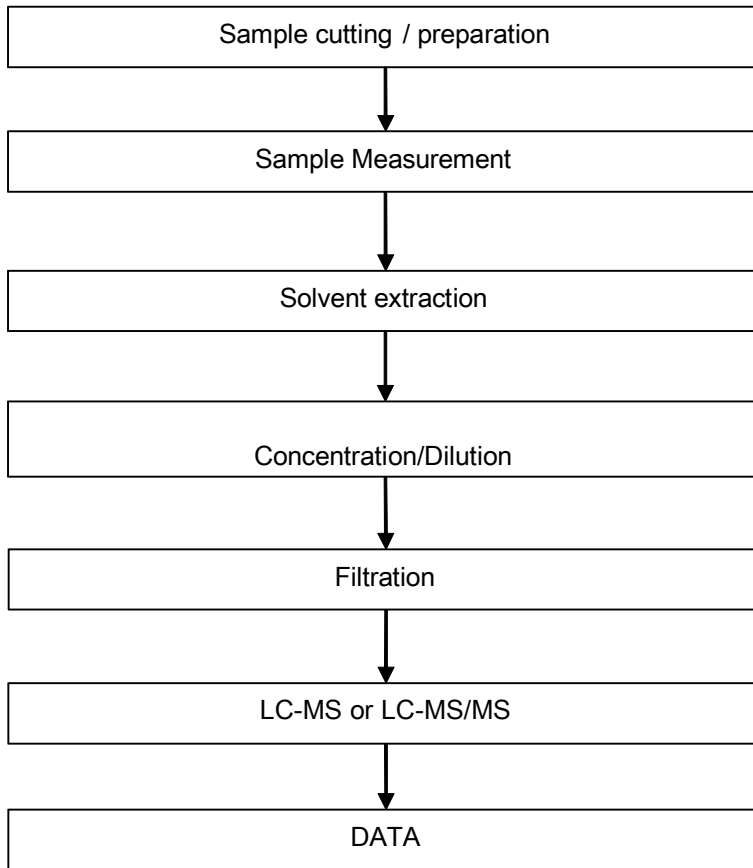

Sample photo:



SGS authenticate the photo on original report only

\*\*\* End of Report \*\*\*





## Test Report

No. CANEC2218227002

Date: 30 Aug 2022

Page 1 of 8

Client Name : SHENZHEN CITY TONGHUA INDUSTRY CO.,LTD

Client Address : TONGHUA MANSIN TONGLE XINBU VILLANG TOWN SHENZHEN CITY CHINA

Sample Name : Gold (AU)

The above sample(s) and information were provided by the client.

SGS Job No. : CP22-047169 - SZ  
 Date of Sample Received : 25 Aug 2022  
 Testing Period : 25 Aug 2022 - 30 Aug 2022  
 Test Requested : Selected test(s) as requested by the client.  
 Test Method(s) : Please refer to next page(s).  
 Test Result(s) : Please refer to next page(s).

Result Summary :

Test Requested	Conclusion
EU RoHS Directive (EU) 2015/863 amending Annex II to Directive 2011/65/EU- Lead, Mercury, Cadmium, Hexavalent chromium, Polybrominated biphenyls (PBBs), Polybrominated diphenyl ethers (PBDEs), Bis(2-ethylhexyl) phthalate (DEHP), Butyl benzyl phthalate (BBP), Dibutyl phthalate (DBP) and Diisobutyl phthalate (DIBP)	PASS
Perfluorooctanoic acid (PFOA) and its salts & Perfluorooctane sulfonates (PFOS) and its derivatives	See Results

Signed for and on behalf of  
 SGS-CSTC Standards Technical Services Co., Ltd. Guangzhou Branch

*Dongyu Xie*

Dongyu Xie  
 Approved Signatory

scan to see the report



9B230D54



## Test Report

No. CANEC2218227002

Date: 30 Aug 2022

Page 2 of 8

Test Result(s) :

Test Part Description :

Specimen No.	SGS Sample ID	Description
SN1	CAN22-182270.002	Gold plated metal

Remarks :

- (1) 1 mg/kg = 0.0001%
- (2) MDL = Method Detection Limit
- (3) ND = Not Detected ( < MDL )
- (4) "-" = Not Regulated

**EU RoHS Directive (EU) 2015/863 amending Annex II to Directive 2011/65/EU- Lead, Mercury, Cadmium, Hexavalent chromium, Polybrominated biphenyls (PBBs), Polybrominated diphenyl ethers (PBDEs), Bis(2-ethylhexyl) phthalate (DEHP), Butyl benzyl phthalate (BBP), Dibutyl phthalate (DBP) and Diisobutyl phthalate (DIBP)**

Test Method : With reference to IEC 62321-4:2013+A1:2017, IEC 62321-5:2013, IEC 62321-7-1:2015 , IEC 62321-6:2015 and IEC 62321-8:2017, analyzed by ICP-OES , UV-Vis and GC-MS .

<u>Test Item(s)</u>	<u>Limit</u>	<u>Unit</u>	<u>MDL</u>	<u>002</u>
Cadmium (Cd)	100	mg/kg	2	ND
Lead (Pb)	1000	mg/kg	2	50
Mercury (Hg)	1000	mg/kg	2	ND
Hexavalent Chromium (Cr(VI))▼	-	µg/cm <sup>2</sup>	0.10	ND
Sum of PBBs	1000	mg/kg	-	ND
Monobromobiphenyl	-	mg/kg	5	ND
Dibromobiphenyl	-	mg/kg	5	ND
Tribromobiphenyl	-	mg/kg	5	ND
Tetrabromobiphenyl	-	mg/kg	5	ND
Pentabromobiphenyl	-	mg/kg	5	ND
Hexabromobiphenyl	-	mg/kg	5	ND
Heptabromobiphenyl	-	mg/kg	5	ND
Octabromobiphenyl	-	mg/kg	5	ND
Nonabromobiphenyl	-	mg/kg	5	ND
Decabromobiphenyl	-	mg/kg	5	ND
Sum of PBDEs	1000	mg/kg	-	ND
Monobromodiphenyl ether	-	mg/kg	5	ND
Dibromodiphenyl ether	-	mg/kg	5	ND
Tribromodiphenyl ether	-	mg/kg	5	ND
Tetrabromodiphenyl ether	-	mg/kg	5	ND



Unless otherwise agreed in writing, this document is issued by the Company subject to its General Conditions of Service printed overleaf, available on request or accessible at <http://www.sgs.com/en/Terms-and-Conditions.aspx> and, for electronic format documents, subject to Terms and Conditions for Electronic Documents at <http://www.sgs.com/en/Terms-and-Conditions/Terms-e-Document.aspx>. Attention is drawn to the limitation of liability, indemnification and jurisdiction issues defined therein. Any holder of this document is advised that information contained hereon reflects the Company's findings at the time of its intervention only and within the limits of Client's instructions, if any. The Company's sole responsibility is to its Client and this document does not exonerate parties to a transaction from exercising all their rights and obligations under the transaction documents. This document cannot be reproduced except in full, without prior written approval of the Company. Any unauthorized alteration, forgery or falsification of the content or appearance of this document is unlawful and offenders may be prosecuted to the fullest extent of the law. Unless otherwise stated the results shown in this test report refer only to the sample(s) tested.

Attention: To check the authenticity of testing /inspection report & certificate, please contact us at telephone: (86-755) 8307 1443, or email: [CN.Doccheck@sgs.com](mailto:CN.Doccheck@sgs.com)

## Test Report

No. CANEC2218227002

Date: 30 Aug 2022

Page 3 of 8

<u>Test Item(s)</u>	<u>Limit</u>	<u>Unit</u>	<u>MDL</u>	<u>002</u>
Pentabromodiphenyl ether	-	mg/kg	5	ND
Hexabromodiphenyl ether	-	mg/kg	5	ND
Heptabromodiphenyl ether	-	mg/kg	5	ND
Octabromodiphenyl ether	-	mg/kg	5	ND
Nonabromodiphenyl ether	-	mg/kg	5	ND
Decabromodiphenyl ether	-	mg/kg	5	ND
Dibutyl phthalate (DBP)	1000	mg/kg	50	ND
Butyl benzyl phthalate (BBP)	1000	mg/kg	50	ND
Bis (2-ethylhexyl) phthalate (DEHP)	1000	mg/kg	50	ND
Diisobutyl Phthalates (DIBP)	1000	mg/kg	50	ND

### Notes :

- (1) The maximum permissible limit is quoted from RoHS Directive (EU) 2015/863.
- (2) IEC 62321 series is equivalent to EN 62321 series
- (3) ▼= a. The sample is positive for CrVI if the CrVI concentration is greater than 0.13 µg/cm<sup>2</sup>. The sample coating is considered to contain CrVI  
 b. The sample is negative for CrVI if CrVI is ND (concentration less than 0.10 µg/cm<sup>2</sup>). The coating is considered a non-CrVI based coating  
 c. The result between 0.10 µg/cm<sup>2</sup> and 0.13 µg/cm<sup>2</sup> is considered to be inconclusive - unavoidable coating variations may influence the determination  
 Information on storage conditions and production date of the tested sample is unavailable and thus Cr(VI) results represent status of the sample at the time of testing.

### Perfluorooctanoic acid (PFOA) and its salts & Perfluorooctane sulfonates (PFOS) and its derivatives

Test Method : With reference to CEN/TS15968:2010, analysis was performed by LC-MS or LC-MS/MS.

<u>Test Item(s)</u>	<u>CAS NO.</u>	<u>Unit</u>	<u>MDL</u>	<u>002</u>
Perfluorooctanoic acid (PFOA) and its salts+	335-67-1	mg/kg	0.010	ND
Perfluorooctane sulfonates (PFOS) ^	1763-23-1	mg/kg	0.010	ND
Perfluorooctane Sulfonamide (PFOSA)	754-91-6	mg/kg	0.010	ND
N-methylperfluoro-1-octanesulfonamide(MeFOSA)	31506-32-8	mg/kg	0.010	ND
N-ethylperfluoro-1-octanesulfonamide (EtFOSA)	4151-50-2	mg/kg	0.010	ND
2-(N-methylperfluoro-1-octanesulfonamido)-ethanol(MeFOSE)	24448-09-7	mg/kg	0.010	ND
2-(N-ethylperfluoro-1-octanesulfonamido)-ethanol(EtFOSE)	1691-99-2	mg/kg	0.010	ND
Perfluorooctane sulfonates (PFOS) and its derivatives	-	mg/kg	-	ND

### Notes :



Unless otherwise agreed in writing, this document is issued by the Company subject to its General Conditions of Service printed overleaf, available on request or accessible at <http://www.sgs.com/en/Terms-and-Conditions.aspx> and, for electronic format documents, subject to Terms and Conditions for Electronic Documents at <http://www.sgs.com/en/Terms-and-Conditions/Terms-e-Documents.aspx>. Attention is drawn to the limitation of liability, indemnification and jurisdiction issues defined therein. Any holder of this document is advised that information contained hereon reflects the Company's findings at the time of its intervention only and within the limits of Client's instructions, if any. The Company's sole responsibility is to its Client and this document does not exonerate parties to a transaction from exercising all their rights and obligations under the transaction documents. This document cannot be reproduced except in full, without prior written approval of the Company. Any unauthorized alteration, forgery or falsification of the content or appearance of this document is unlawful and offenders may be prosecuted to the fullest extent of the law. Unless otherwise stated the results shown in this test report refer only to the sample(s) tested.

Attention: To check the authenticity of testing /inspection report & certificate, please contact us at telephone: (86-755) 8307 1443, or email: [CN.Doccheck@sgs.com](mailto:CN.Doccheck@sgs.com)

- (1) + PFOA and its salts including PFOA-Na (CAS No.: 335-95-5), PFOA-K (CAS No.: 2395-00-8), PFOA-Ag (CAS No.: 335-93-3), PFOA-F (CAS No.: 335-66-0) and APFO (CAS No.: 3825-26-1);  
 (2) ^ PFOS including PFOS-K (CAS No.: 2795-39-3), PFOS-Li (CAS No.: 29457-72-5), PFOS-NH<sub>4</sub> (CAS No.: 29081-56-9), PFOS-NH(OH)<sub>2</sub> (CAS No.: 70225-14-8), PFOS-N(C<sub>2</sub>H<sub>5</sub>)<sub>4</sub> (CAS No.: 56773-42-3), PFOS-DDA (CAS No.: 251099-16-8) and POSF (CAS No.: 307-35-7)

Unless otherwise stated, the decision rule for conformity reporting is based on Binary Statement for Simple Acceptance Rule ( $w=0$ ) stated in ILAC-G8:09/2019.



Unless otherwise agreed in writing, this document is issued by the Company subject to its General Conditions of Service printed overleaf, available on request or accessible at <http://www.sgs.com/en/Terms-and-Conditions.aspx> and, for electronic format documents, subject to Terms and Conditions for Electronic Documents at <http://www.sgs.com/en/Terms-and-Conditions/Terms-e-Documents.aspx>. Attention is drawn to the limitation of liability, indemnification and jurisdiction issues defined therein. Any holder of this document is advised that information contained hereon reflects the Company's findings at the time of its intervention only and within the limits of Client's instructions, if any. The Company's sole responsibility is to its Client and this document does not exonerate parties to a transaction from exercising all their rights and obligations under the transaction documents. This document cannot be reproduced except in full, without prior written approval of the Company. Any unauthorized alteration, forgery or falsification of the content or appearance of this document is unlawful and offenders may be prosecuted to the fullest extent of the law. Unless otherwise stated the results shown in this test report refer only to the sample(s) tested.

Attention: To check the authenticity of testing / inspection report & certificate, please contact us at telephone: (86-755) 8307 1443, or email: [CN.Doccheck@sgs.com](mailto:CN.Doccheck@sgs.com)

ATTACHMENTS

Pb/Cd/Hg/Cr<sup>6+</sup>/PBBs/PBDEs Testing Flow Chart

1) These samples were dissolved totally by pre-conditioning method according to below flow chart. (Cr<sup>6+</sup> and PBBs/PBDEs test method excluded).

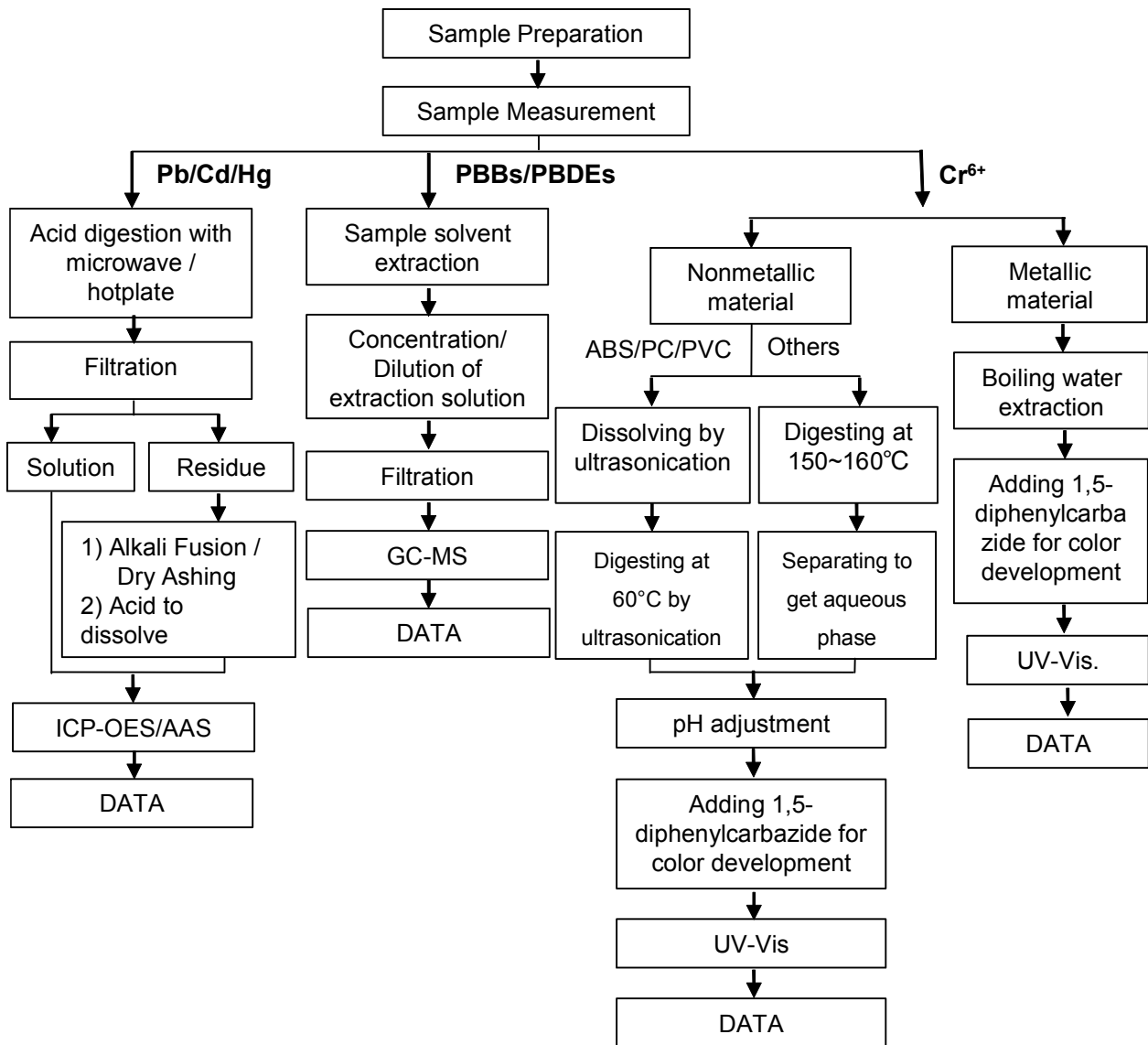

## ATTACHMENTS

### Phthalates Testing Flow Chart

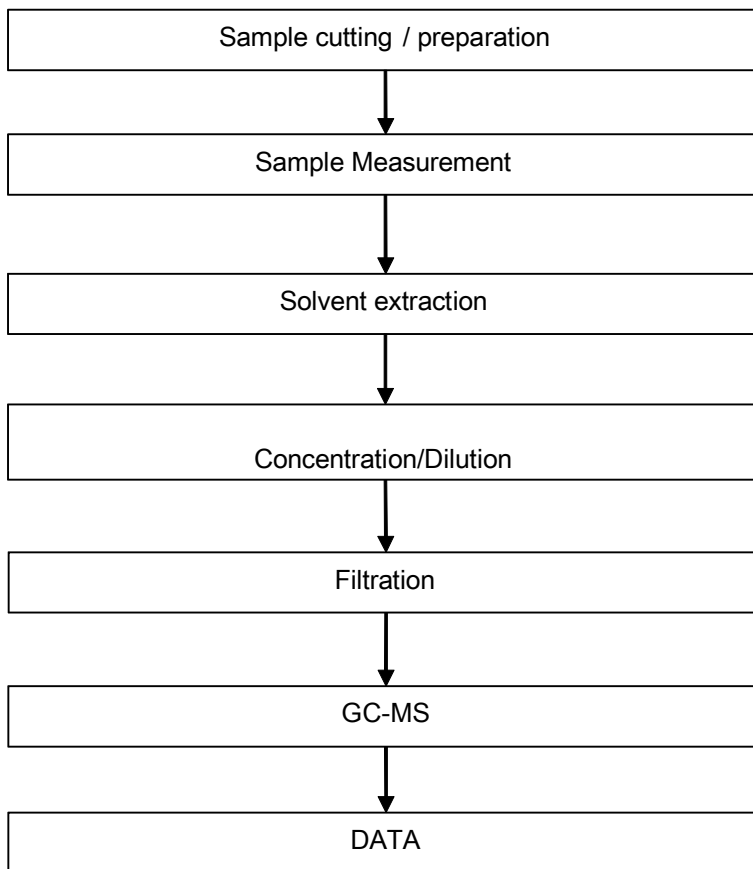

Unless otherwise agreed in writing, this document is issued by the Company subject to its General Conditions of Service printed overleaf, available on request or accessible at <http://www.sgs.com/en/Terms-and-Conditions.aspx> and, for electronic format documents, subject to Terms and Conditions for Electronic Documents at <http://www.sgs.com/en/Terms-and-Conditions/Terms-e-Document.aspx>. Attention is drawn to the limitation of liability, indemnification and jurisdiction issues defined therein. Any holder of this document is advised that information contained hereon reflects the Company's findings at the time of its intervention only and within the limits of Client's instructions, if any. The Company's sole responsibility is to its Client and this document does not exonerate parties to a transaction from exercising all their rights and obligations under the transaction documents. This document cannot be reproduced except in full, without prior written approval of the Company. Any unauthorized alteration, forgery or falsification of the content or appearance of this document is unlawful and offenders may be prosecuted to the fullest extent of the law. Unless otherwise stated the results shown in this test report refer only to the sample(s) tested.

Attention: To check the authenticity of testing / inspection report & certificate, please contact us at telephone: (86-755) 8307 1443, or email: [CN\\_Doccheck@sgs.com](mailto:CN_Doccheck@sgs.com)

ATTACHMENTS

PFOA / PFOS Testing Flow Chart

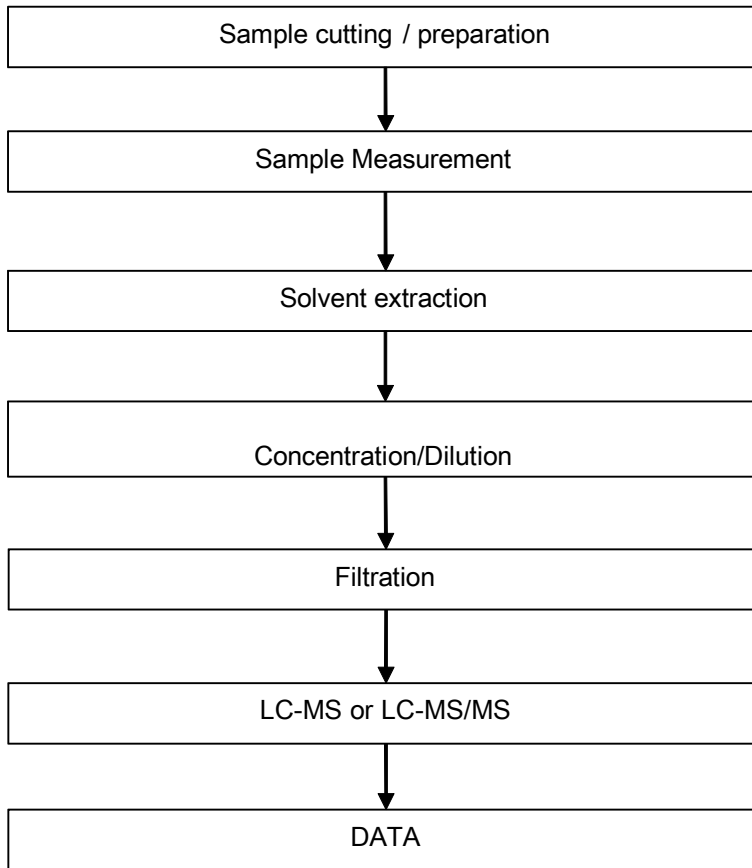

Unless otherwise agreed in writing, this document is issued by the Company subject to its General Conditions of Service printed overleaf, available on request or accessible at <http://www.sgs.com/en/Terms-and-Conditions.aspx> and, for electronic format documents, subject to Terms and Conditions for Electronic Documents at <http://www.sgs.com/en/Terms-and-Conditions/Terms-e-Document.aspx>. Attention is drawn to the limitation of liability, indemnification and jurisdiction issues defined therein. Any holder of this document is advised that information contained hereon reflects the Company's findings at the time of its intervention only and within the limits of Client's instructions, if any. The Company's sole responsibility is to its Client and this document does not exonerate parties to a transaction from exercising all their rights and obligations under the transaction documents. This document cannot be reproduced except in full, without prior written approval of the Company. Any unauthorized alteration, forgery or falsification of the content or appearance of this document is unlawful and offenders may be prosecuted to the fullest extent of the law. Unless otherwise stated the results shown in this test report refer only to the sample(s) tested.

Attention: To check the authenticity of testing / inspection report & certificate, please contact us at telephone: (86-755) 8307 1443, or email: [CN\\_Doccheck@sgs.com](mailto:CN_Doccheck@sgs.com)

Sample photo:



SGS authenticate the photo on original report only

\*\*\* End of Report \*\*\*

