

REV.	ECN.NO.	APPD.
A	/	chenyiting

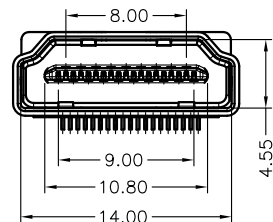

WITHOUT COVER

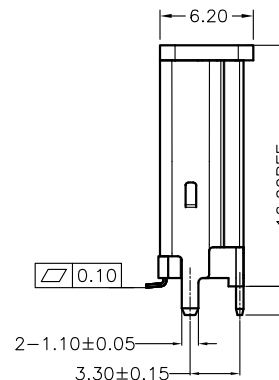
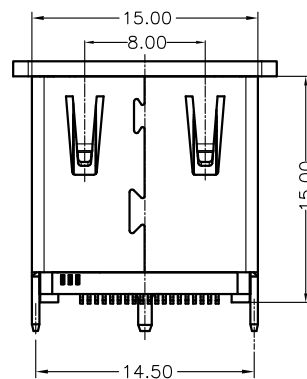
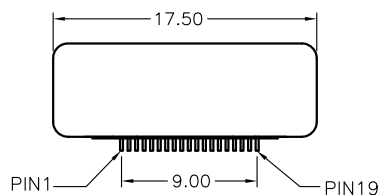
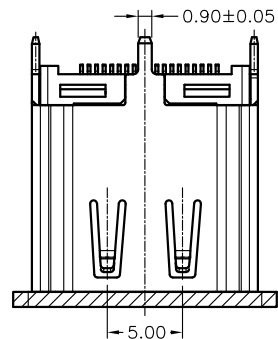

HD27-0315-G61081

- 5: 铜壳镀镍
- 8: 载带
- G: 半金G/Fu
- 1: 黑色
- 6: LCP

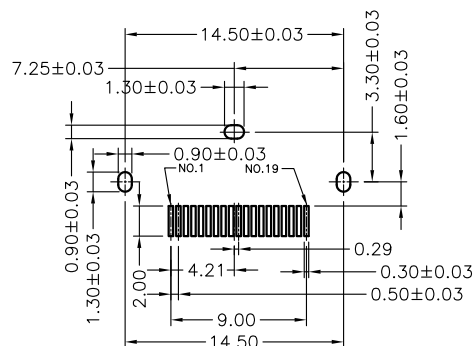

RECOMMENDED PCB LAYOUT (T=1.60mm)
TOP VIEW

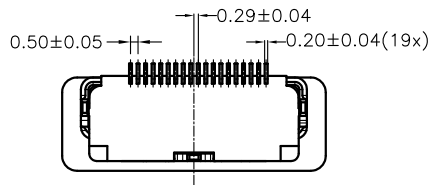

NOTES:

1. MATERIAL:
 - 1.1 Housing: thermoplastic plastics
 - 1.2 terminals: Copper Alloy
Gold plated in contact area:
Tin plated in termination
Nickel Plated overall
 - 1.3 Shell: Steel & Copper Alloy
Nickel/Au Plated overall
2. ELECTRICAL CHARACTERISTICS:
 - 2.1 Rating Current : 0.5 Ampere
 - 2.2 Rating Voltage : 40 V Max
 - 2.3 Contact Resistance: 30 Milli ohms
 - 2.4 Insulation Resistance: 100 Mega ohms Min.
3. MECHANICAL CHARACTERISTICS:
 - 3.1 Connector Mating force: 4.5kg MAX
 - 3.2 Connector Unmating force: 1.0Kg min
 - 3.3 Durability: 10000 Cycles.
4. ENVIRONMENT CHARACTERISTICS:
 - 4.1 Operating temperature: -20°C to +85°C
 - 4.2 Storage temperature: -20°C to +65°C

TOLERANCE UNLESS OTHERWISE SPECIFIED		FLW 深圳市华联威电子科技有限公司			
.XXX ±0.10	.XX ±0.20	.X ±0.30	HUA LIAN WEI TECHNOLOGY ELECTRONICS CO.;LTD.		
.XX ±0.20	.X ±0.30	.X ±0.30			
APPROVED		PART NAME:	HDMI 19P/F 180° 立式(H=15mm) 针长1.9		
CHECKED		PART No:	HD27-0315-G61081	C	
DRAWN	chenyiting	PROJECTION:	UNIT:	SCALE	SHEET
DATE	2022.06.26		mm	1:1	10F1
					REV. A