

承 认 书

Approval Sheet

客户 (Customer): /

客户料号 (Cus .P/N): /

华联威料号 (HLW P/N): U578-1025-G61038

品名规格 (PronameSpec): TYPE C 16PIN

送样日期 (Delivery Date):2021/12/06

承认日期 (Acknowledge Date):2021/12/06

Approved No:		客 户 Customer	
采 购 部 Purchasing Dept	品 质 部 QC Dept	工 程 部 Engineering Dept	确 认 Approved By
深 圳 市 华 联 威 电 子 科 技 有 限 公 司 SHEN ZHEN SHI HUA LIAN WEI ELECTRONICS TECHNOLOGY CO; LTD.			
业 务 部 Sales Dept	品 管 部 QC Dept	工 程 部 Engineering Dept	核 准 Checked By
陈少萍	欠必锋	魏红	唐竹君

地址:深圳市龙华区观澜街道桂香社区观澜桂花路 307 号

TEL: 0755-28888886 28888866

hua@hlwconn.com

[Http://www.hlwconn.com](http://www.hlwconn.com)

目 录

Contents

图纸.....	Page03
产品规格书.....	Page04-09
产品检测报告.....	Page10-11
尺寸测试报告.....	Page12
电镀报告.....	Page13-14
盐雾报告.....	Page15
材质证明.....	Page16-17
SGS.....	Page18-51

REV.	ECN.NO.	APPD.
A	/	Hexing

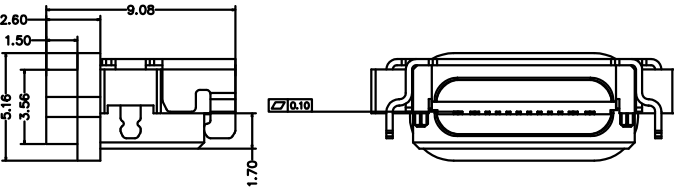
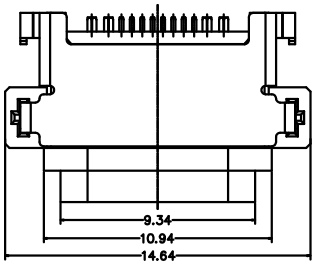

NOTES:
 1.MATERIAL:
 1.1 Housing:thermoplastic plastics
 1.2 terminals:Copper Alloy
 Gold plated in contact area:
 Tin plated in termination
 Nickel Plated overall
 1.3 Shell:Steel&Copper Alloy
 Nickel/Au Plated overall
 2.characteristics:
 2.1 Rating Voltage : 30V AC.
 2.2 Rating Current:
 5A for Vbus PIN;1.25A for Vconn PIN
 2.3 Contact Resistance:40 mΩ MAX.
 2.4 Insulation Resistance:100 MΩ MIN.
 2.5 Withstanding Voltage:AC 100V
 2.6 Mating force: 5~20N MAX
 2.7 Extraction force:8~20N Min
 2.8 Life test:10000Cycles MIN.
 2.9 Temperature Range: -30℃~+80℃.
 The product must be compliance ROHS

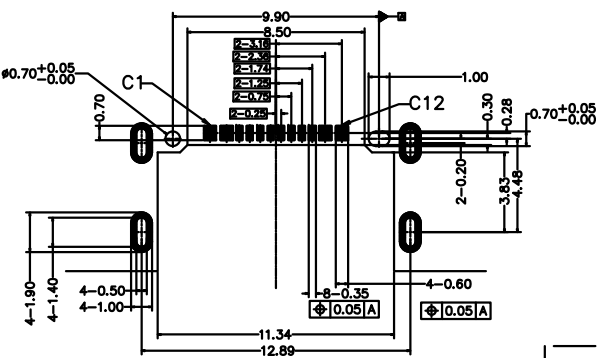
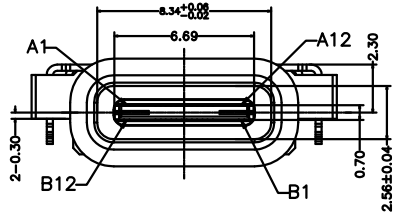

RECOMMENDED PCB LAYOUT(TOP VIEW)
 THICKNESS T=1.0mm
 DEFAULT TOLERANCE+/-0.05

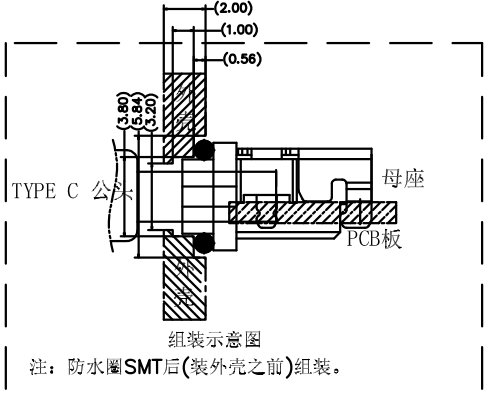

U578-1025-G61038
 G: 半金G/Fu”
 3. 载带冷封
 1: 黑色
 6: LCP

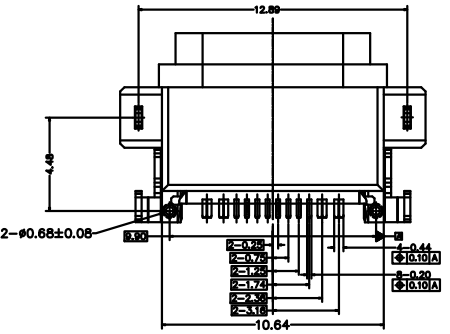

TOLERANCE UNLESS OTHERWISE SPECIFIED		HLW 深圳市华联威电子科技有限公司 HUA LIAN WEI TECHNOLOGY ELECTRONICS CO;LTD.					
.XXX ±0.10	.X' ±3'	APPROVED		PART NAME:		TYPE C 16PIN	
.XX ±0.20	.XX' ±2'	CHECKED		PART No:		U578-1025-G61038	
.X ±0.30		DRAWN weihong		PROJECTION:		UNIT:	SCALE
		DATE 2021.05.27				mm	1:1
						SHEET	REV.
						10F1	A

USB 3.1 TYPE-C系列产品SPEC

版本版次: C

制定日期 20200707

适用范围 通用

1. Scope (范围)

1.1 Contents(内容)

This specification covers the performance, tests and quality requirements for the Electronics USB 3.1 TYPE-C Connector.(此份产品规格适用于USB 3.1 TYPE-C连接器的产品功能, 测试方法及质量要求)

2. Requirements (要求):

2.1 Rating(额定条件)

A. Voltage rating(额定电压):30V AC

B. Current rating(额定电流):1.5A

C. Operation Temperature Range(工作温度范围):-30°C to +80°C

3. Test Condition(测试条件):

3.1 Temperature range(温度范围):-15°C to +35°C

3.2 Humidity range (湿度范围):25% to 85%

4. Test Methods and Requirements:(测试方法及要求)

4.1 Examination of product (产品外观)

4.1	Examination of Product 1. 产品外观	Visual 目视	No peeling off the plating deformation of the base or damage. 不得有电镀层剥落, 塑料变形或破损
-----	-----------------------------------	--------------	---

4.2. Electrical Performance(电气性能)

4.2	Contact Resistance 1. 接触阻抗	(EIA-364-06B) 适合USB 3.1 TYPE-C嵌合; 开放电压20mv以下; 短路电流100ma的状态下测定。 Mate applicable USB 3.1 TYPE-C and measure by dry circuit, 20mv MAX, 100mA. 40mΩMAX	40mΩ MAX
4.2	Dielectric Withstanding Voltage 2. (耐电压)	(EIA-364-20C) Unmated connectors, apply 100V AC (RMS.) for 1 minute between adjacent terminals of ground. 没有配对的连接器在相邻的端子或接地之间通上100V的交流电压1分钟	1. No Breakdown or flashover 2. Leakage current:0.5mA Max 1. 不能有损坏或跳火花 2. 漏电流<0.5mA
4.2	Insulation Resistance 3. 绝缘阻抗	(EIA-364-21C) Unmated connectors, apply 500V DC for 1 minute between adjacent terminals of ground. 没有配对的连接器在相邻的端子或接地之间通上500V的直流电压1分钟	100MΩ min (unmated) 没有配对需大于100 MΩ

4.3Mechanical Performance(机械性能)

4. 3. 1	Insertion/Withdrawal Force 插入力/拔出 力	(EIA-364-13) Insertion and withdrawal speed: 25mm/minute. 插入和拔出的速度为25mm/分	插入力 Insertion 0.50kgf/MIN, 2.0kgf/MAX 拔出力 Withdrawal 0.80kgf/MIN, 2.0kgf/MAX After 10000 cycles 0.6kgf/MIN, 2.0kgf/MAX
4. 3. 2	Durability 寿命测试	(EIA-364-09) 适合USB 3.1 TYPE-C; 用每分钟12.5mm的速度, 平行的插入, 拔出。 Insert and extract applicable USB 3.1 TYPE-C at the speed rate of 12.5 mm/minute.	10000 cycles
4. 3. 3	Humidity-Temperature cycle 温湿度循环		
4. 3. 4	Vibration 振动	(EIA-364-28条件3) Amplitude:1.52mm P-P or 147m/s ² {15G} Sweep time: 50-2000-50Hz in 20 minutes. Duration: 12 times in each (total of 36 times) X, Y, Z, axes. Electrical load DC 100mA current shall be flowed during the test.(ANSI/EIA-364-28 Condition III) 在直流100毫安通电状态下测试, 在X,Y,Z垂直3方向上, 频率50-2000-50赫兹(加速度往复20分钟), 全振幅1.52mm P-P或147 m/s ² {15G}, 每轴12回计36回	Appearance: No damage 外观: 无损坏 Contact Resistance 接触阻抗 Contact: Change from initial Value:30mΩ Max. 端子: 从初始值开始变化量小于30mΩ 间断性: 不超过1微秒
4. 3. 4	Physical shock 冲击性	(EIA-364-27条件A) Pulse width: 11msec Waveform: Half-sine 490m/s ² (50G) 3 strokes in each X, Y, Z axes. (ANSI/EIA-364-27 condition A) 周期: 11msec 冲击波形: 正弦半波490m/s ² (50G) 3循环在X, Y, Z轴	Appearance: No damage 外观: 无损坏 Contact Resistance 接触阻抗 Contact: Change from initial Value 40mΩ Max 端子: 从初始值开始变化量小于40mΩ Discontinuity: 1μ sec Max. 间断性: 不超过1微秒
4.4 Environmental Performance			

4. 4. .1	Thermal shock test 冷热冲击	EIA-364-32C条件1) 10 cycles of: a)-55±3℃ for 30 minutes b) +85±3℃ for 30 minutes 10个循环, a)-55±3℃ 30 分钟 b) +85±3℃ 30 分钟	Appearance: No Damage. 外观: 没有损坏 Contact Resistance 接触阻抗 Contact: Change from initial Value 40mΩ Max 端子: 从初始值开始变化量小于40mΩ
4. 4. .2	Solder ability 焊锡性	(EIA-364-52) To be sipped in the solder bath 245±5℃ Coverage for 3 seconds. 将焊锡脚浸在245±5℃的锡炉中<3秒	The inspected area of each lead must have 90% solder coverage minimum
4. 4. .3	Humidity 恒温恒湿	(EIA-364-31B) (A) Mate connectors together and perform the test as follows 配对的连接器测试条件 Temperature: +25℃ to +85℃(温度: +25℃到+85℃) Relative Humidity: 90% to 95%(相对湿度: 90%到95%) Duration:4 cycles(96 hours) (持续时间: 4个循环共96小时) Upon completion of the test, specimens shall be conditioned ambient room conditions for 24 hours, after which the specified measurements shall be performed. 试验完成后, 样品放置于室温条件中24小时后再进行测试	Appearance: No Damage 外观, 没有损坏 Contact Resistance 接触阻抗 Contact: Change from initial Value 30mΩ Max 端子: 从初始值开始变化量小于30mΩ
4. 4. .4	Salt Spray 盐水喷雾	EIA-364-26B) Temperature: 35±2℃ 温度: 35±2℃ Concentration for salt: 5% 盐水浓度: 5% (1)Duration: 24H 持续时间: 24小时 Condition(条件): Contact plated gold more than 15u" (include 15 u"),and the material of shell for copper alloy, or stainless. 端子镀金厚度大于等于15 u" 且壳体材质是铜合金或是不锈钢 (2) Duration: 12H 持续时间: 12小时 Condition(条件): Contact plated gold less than 15 u" ,and/or the material of shell for steel 端子镀金厚度小于15u" 且/或壳体材质是铁材	No detrimental corrosion(Terminal solder tail unrequested) 产品无氧化, 锈蚀(端子焊脚镀锡处不作要求)

4.5	Cold resistance (Unmated) 冷阻抗	(EIA-364-17B) Unmated connectors and expose to $-25\pm 3^{\circ}\text{C}$ for 168 hours. Upon completion of the exposure period, the test specimens shall be conditioned at ambient room conditions for 1 to 2 hours, after which the specified measurements shall be performed. 没配对的连接器放置于 $-25\pm 3^{\circ}\text{C}$ 温度中168小时，当完成实验后，样品放置一般环境中1到2小时后，在进行测试	Appearance: No Damage. 外观：没有损坏 Contact Resistance 接触阻抗 Contact: Change from initial Value 30mΩ Max Shell Part: Change from initial Value 50mΩ Max 端子：从初始值开始变化量小于30mΩ 外壳：从初始值开始变化量小于50mΩ
4.6	Heat resistance (Unmated) 热阻抗	(EIA-364-17B) Mated connectors and expose to $85\pm 2^{\circ}\text{C}$ for 168 hours. Upon completion of the exposure period, the test specimens shall be conditioned at ambient room conditions for 1 to 2 hours, after which the specified measurements shall be performed. 配对的连接器放置于 $85\pm 2^{\circ}\text{C}$ 温度中168小时，当完成实验后，样品放置一般环境中1到2小时后，在进行测试	Appearance: No Damage. 外观：没有损坏 Contact Resistance 接触阻抗 Contact: Change from initial Value 30mΩ Max Shell Part: Change from initial Value 50mΩ Max 端子：从初始值开始变化量小于30mΩ 外壳：从初始值开始变化量小于50mΩ
4.7	Thermal Aging 高温老化	(EIA-364-31B, Condition 4, Method A) Unmated connectors and expose to $+85\pm 2^{\circ}\text{C}$ for 250 hours. Upon completion of the exposure period, the test specimens shall be conditioned at ambient room conditions for 1 to 2 hours, after which the specified measurements shall be performed. 没配对的连接器放置于 $+85\pm 2^{\circ}\text{C}$ 温度中250小时，当完成实验后，样品放置一般环境中1到2小时后，在进行测试	Appearance: No Damage. 外观：没有损坏 Contact Resistance 接触阻抗 Contact: Change from initial Value 40mΩ Max 端子：从初始值开始变化量小于40m
4.8	Resistance to Soldering Heat	for wave soldering : mil-std-202f,method 210 A,test condition B 波峰焊：mil-std-202f, method 210 A, 试验条件B Pre-heat : 80°C , 60 Seconds 预热: 80°C , 60秒 Temperature : $260 \pm 5^{\circ}\text{C}$ 温度: $260\pm 5^{\circ}\text{C}$ Immersion duration : 10 ± 1 sec. 浸泡时间: 10 ± 1 秒。 for manual soldering :手动焊接: mil-std-202f,method 210 A,test condition A Pre-heat : No 预热:没有 Temperature : $350 \pm 10^{\circ}\text{C}$ 温度: $350\pm 10^{\circ}\text{C}$ Immersion duration : 3.5 ± 0.5 sec.浸泡时间: 3.5 ± 0.5 秒	No physical damage shall occur. 不可有损坏 Reflow welding is not applicable to PBT 回流焊不适用于PBT

Solder Temp: 260±5°C,10±0.5sec

焊锡温度: 260±5°C,10±0.5sec

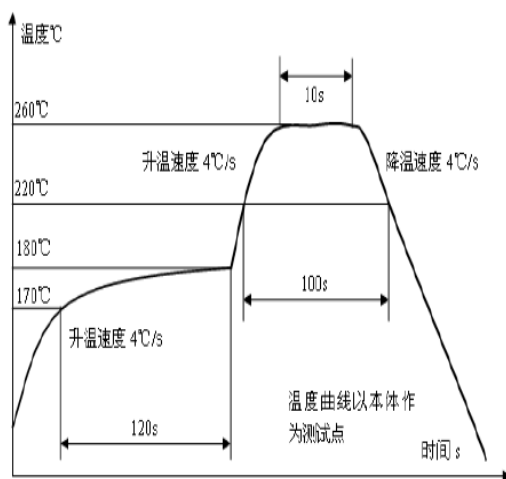

Note 1: Shall meet visual requirements, show no physical damage, and meet requirement of additional tests as specified in the test sequence in Figures 2

说明1: 测试要求不能有物理损坏, 测试依据表格二的顺序进行

3.Product Qualification And Requalification Test:产品测试顺序表 Figure 2

Test or Examination	Test Group														
	A	B	C	D	E	F	G	H	I	J	K	L	M	N	
Test Sequence															
4.1.1.Examination of Product 产	1,9	1,3	1,5	1	1,5	1,5	1,5	1,3		1,5	1,5	1,5	1,5	1,5	1
4.2.1.Contact Resistance 接触	2,8		2,4		2,4	2,4	2,4			2,4	2,4	2,4	2,4	2,4	
4.2.2.Dielectric Withstanding	3,7														
4.2.3.Insulation Resistance 绝缘	4,6														
4.3.1.Insertion/Withdrawal force		2													
4.3.2.Durability 寿命测试			3												
4.3.3.Vibration 振动性					3										
4.3.4.Physical shock 冲击性						3									
4.4.1.Thermal shock test 冷热							3								
4.4.2.Solderability 焊锡性								2							
4.4.3.Humidity 恒温恒湿	5									3					
4.4.4.Salt Spray 盐水喷雾										3					
4.4.5.Cold resistance 冷阻											3				

4.4.6.Heat resistance 热阻												3		
4.4.7.Thermal Aging 高温老化													3	
4.4.8.IR-reflow 回流焊测试														2
NO. of Test samples(Min.) 测	5	5	5	5	5	5	5	5		5	5	5	5	5

NOTE 2: (a) Numbers indicate sequence in which tests are performed.
(b) Discontinuities shall not take place in this test group, during tests.
说明 2: (a)测试依照矩阵要求数量进行。
(b)在测试中，群组测试不能间断

核准：唐竹君

制作人：魏红

測試報告

TEST REPORT

產品名稱 Part Name	TYPE C 16PIN	測試日期 Date of Testing	2021.12.03 2021.12.04	報告編號 Report NO.	MD20211204-01
產品型號 Part Name	U578-1025-G61038	樣品數量 Quantity	5PCS	測試環境 Measuring Environment	濕度 Temp:18 ±1°C 相對濕度 R.H.:49% f57%

一. 電性測試 ELECTRICAL TEST

序號 NO.	測試項目 Testing Item	測試條件 Testing Conditions	測試設備 Testing Equipment	規格 SPEC	測試記錄 Testing Result					判定 Judge	
					1	2	3	4	5	Pass	Fail
1	Contact resistance	Test current:100mA max	DIGITAL MICRO—OHMMETER	40 mΩ Max	14.77 mΩ	15.42 mΩ	15.86 mΩ	16.37 mΩ	17.53 mΩ	P	
2	Insulation resistance	Test voltage:500VDC Operation stated:1min	ULTRA HIGH RESISTANCE METER	100 mΩ Min	Pass	Pass	Pass	Pass	Pass	P	
3	Dielectric withstand voltage	Test voltage:100VAC Cut—off current:0.5mA Operation stated:1 min	BREAKDOWN TESTER	No discharge or flashover occur	Pass	Pass	Pass	Pass	Pass	P	

二. 機械特性測試 MECHANICAL TEST

序號 NO.	測試項目 Testing Item	測試條件 Testing Conditions	測試設備 Testing Equipment	規格 SPEC	測試記錄 Testing Result					判定 Judge	
					1	2	3	4	5	Pass	Fail
1	Durability test	Rate:200cycles/hour Total: 10000 cycles	LIFE TESTER FOR CONNECTOR	No physical damage	Pass	Pass	Pass	Pass	Pass	P	
2	Mating Force	5N-20Newtons maximum at a maximum rate of 12.5mm per minute	Insertion force testing machine	No physical damage	Pass	Pass	Pass	Pass	Pass	P	
3	Un—Mating Force	8N-20N Newtons minimum at a maximum rate of 12.5mm per minute	Insertion force testing machine	No physical damage	Pass	Pass	Pass	Pass	Pass	P	

三. 環境特性測試 ENVIRONMENTAL TEST

序號 NO.	測試項目 Testing Item	測試條件 Testing Conditions	測試設備 Testing Equipment	規格 SPEC	測試記錄 Testing Result					判定 Judge	
					1	2	3	4	5	Pass	Fail
1	Humidity—Temperature cycle	Temperature: 40±2°C Duration :168H	PROGRAM CONTROLLED TEMP. & HUMIDTY CHAMBER	No physical damage	Pass	Pass	Pass	Pass	Pass	P	
2	Heat test	Temperature: 70±2°C Duration :168H	OVEN	No physical damage	Pass	Pass	Pass	Pass	Pass	P	

3	Cold test	Temperature: -25 ±3°C Duration: 168H	PROGRAM CONTROLLED TEMP. & HUMIDITY CHAMBER	No physical damage	Pass	Pass	Pass	Pass	Pass	P	
4	Temperature cycling test	Temperature: 70—25°C Duration: 5 cycle	PROGRAM CONTROLLED TEMP. & HUMIDITY CHAMBER	No physical damage	Pass	Pass	Pass	Pass	Pass	P	

四.物理測試 PHYSICAL TEST

序 NO.	測試項目 Testing Item	測試條件 Testing Con di tions	測試設備 Testing Equipment	規格 SPEC	測試記錄 Testing Result					判定 Judge	
					1	2	3	4	5	Pass	Fail
1	Salt spray test	Temperature: 35±2°C Concentration: 5±1 % Duration: 12H	SALT SPRAY TESTER	No Oxidation	Pass	Pass	Pass	Pass	Pass	P	
2	Solder ability test	Temperature: 260 ± 5°C Duration: 10 ±1 sec	OVEN	NO physical damage	Pass	Pass	Pass	Pass	Pass	P	
3	Solder ability test	Temperature: 260 ±10 C Duration :10 ±1 sec	CONTROLLED CONSTANT-TEMP SOLDER POT	Soldering area 三 95%	Pass	Pass	Pass	Pass	Pass	P	
判定 Result		<input checked="" type="checkbox"/> 合格(ACCEPT) <input type="checkbox"/> 不合格(REJECT)									

核准(Approver): 欠必鋒

測試(Tester): 但芬



深圳市华联威电子科技有限公司

檢驗報告

首件檢驗
 入庫檢驗
 出貨檢驗
 客退檢驗
 退料檢驗
 其他
 2021年12月6日 版次:A1

料號	U578-1025-G61038		制令單號	/		送檢單位	工程部		首件製作者	裝配			
品名	TYPE C 16PIN		客戶代號	/		批 量	/		送檢時間	/			
						數 量	5PCS		確認時間	/			
抽樣標準			<input checked="" type="checkbox"/> 單次 <input type="checkbox"/> 雙次			抽樣數	AQL	CRI:0	MAJ:0.4	MIN:0.65			
MIL-STD-105E(II)			<input checked="" type="checkbox"/> 正常 <input type="checkbox"/> 加嚴 <input type="checkbox"/> 減量			(5PCS)	ACC/REJ	0	/	/			
不良數:			CRI (/)		MAJ (/)		MIN (/)		不良率(%)		/		
NO.	檢驗項目 單位:MM/G	檢測 儀器	檢 驗 記 錄					品管判定		CRI	MAJ	MIN	備注
			1	2	3	4	5	AC	RE				
尺 寸 測 量	9.34±0.20	D	9.36	9.40	9.38	9.37	9.36	√					
	10.94±0.20	D	10.96	10.98	10.99	10.91	10.92	√					
	14.64±0.20	D	14.68	14.65	14.63	14.65	14.67	√					
	8.34±0.06/-0.02	D	8.36	8.34	8.35	8.36	8.34	√					
	6.69±0.20	D	6.72	6.70	6.69	6.72	6.73	√					
	2.56±0.04	D	2.52	2.55	2.53	2.57	2.55	√					
	12.89±0.20	D	12.92	12.95	12.96	12.93	12.94	√					
	4.48±0.20	D	4.49	4.50	4.52	4.48	4.46	√					
	10.64±0.20	D	10.67	10.65	10.68	10.67	10.69	√					
	9.08±0.20	D	9.10	9.12	9.15	9.13	9.14	√					
	5.16±0.20	D	5.20	5.18	5.19	5.21	5.20	√					
	1.70±0.20	D	1.76	1.75	1.74	1.73	1.75	√					
檢驗依據: <input checked="" type="checkbox"/> 《工程圖紙》 <input type="checkbox"/> 《檢驗規範》 <input type="checkbox"/> 《承認書》 <input type="checkbox"/> 樣品 <input type="checkbox"/> 其它													
檢測儀器:A游標卡尺 B千分尺 C厚薄儀 D投影鏡 E放大鏡 F顯微鏡 G錫爐 H插拔力器 I間位尺 J其它													
品保判定:			<input checked="" type="checkbox"/> 合格Accept <input type="checkbox"/> 退貨Reject <input type="checkbox"/> 特采Waive <input type="checkbox"/> 挑選Sort										

核准: 欠必鋒

審核: 刘联英

檢驗員: 但芬

电镀报告表

品名:TYPE C 16PIN (端子)		版次:A. 0			
电镀规格:Ni40u", Sn40u", Au G/Fu"		日期:2021-08-25			
页次:1/1					
厂商:同华					
测试设备:CMI X-射线膜厚测试仪					
1、底层电镀测试 (Ni)					
数据	测试标准	实测值	判定	测试日期	测试时间
1	40u"MIN	60.5u"	OK	2021/8/25	10:20:15
2	40u"MIN	58.3u"	OK	2021/8/25	10:20:17
3	40u"MIN	67.5u"	OK	2021/8/25	10:20:19
4	40u"MIN	62.4u"	OK	2021/8/25	10:20:21
2、表层电镀测试 (Sn)					
数据	测试标准	实测值	判定	测试日期	测试时间
1	40u"MIN	115.3u"	OK	2021/8/25	10:25:10
2	40u"MIN	124.7u"	OK	2021/8/25	10:25:12
3	40u"MIN	118.9u"	OK	2021/8/25	10:25:14
4	40u"MIN	112.4u"	OK	2021/8/25	10:25:16
3、表层电镀测试 (Au)					
数据	测试标准	实测值	判定	测试日期	测试时间
1	0.5u"MIN	0.55u"	OK	2021/8/25	10:30:32
2	0.5u"MIN	0.53u"	OK	2021/8/25	10:30:34
3	0.5u"MIN	0.58u"	OK	2021/8/25	10:30:36
4	0.5u"MIN	0.59u"	OK	2021/8/25	10:30:38

核准: 欠必锋

审核: 刘联英

检验员: 但芬

HLWconn® 深圳市华联威电子科技有限公司
电镀报告表

品名:TYPE C 16PIN外壳		版次:A.0			
电镀规格:Cu:40u"Ni50u"MIN	日期:2021/9/12	页次:1/1			
厂商:金和源					
测试设备:CMI X-射线膜厚测试仪					
1、底层电镀测试(Cu)					
数据	测试标准	实测值	判定	测试日期	测试时间
1	40u"min	45.3u"	OK	2021/9/12	19:55:05
2	40u"min	48.5u"	OK	2021/9/12	19:55:57
3	40u"min	44.2u"	OK	2021/9/12	19:56:48
4	40u"min	45.6u"	OK	2021/9/12	19:57:31
2、表层电镀测试(Ni)					
数据	测试标准	实测值	判定	测试日期	测试时间
1	50u"min	50.26u"	OK	2021/9/12	19:58:12
2	50u"min	50.28u"	OK	2021/9/12	19:59:04
3	50u"min	50.18u"	OK	2021/9/12	20:01:44
4	50u"min	50.13u"	OK	2021/9/12	20:02:36

核准: 欠必锋

审核: 刘联英

检验员: 但芬

盐水喷雾实验报告

试验方法	盐水喷雾腐蚀试验法	参考资料	MIL-STD-1216
METHOD	NEUTRL SALT SPRAY CORROSION TEST	REF	
客户	/	试验起始日期	2021年12月03日 20:00 时起
		DATE	2021年12月04日 08:00 时止
样品名称	TYPE C 16PIN	试验数量	5PCS
P/N	U578-1025-G61038		

试验条件 (TEST CONDITION)

- 1、盐水溶解 (SALT SOLUTION: 浓度 $50 \pm 10\text{g/L}$, PH值6.5-7.2).
- 2、试验室温度 (TEMP. IT THE SPRAY DHAMBR): $35 \pm 1^\circ\text{C}$.
- 3、盐水桶温度 (TEMP. OF SALE SOL' N TANK): $35 \pm 1^\circ\text{C}$.
- 4、压力桶温度 (TEMP. OF SAR SUPPLIERY): $47 \pm 1^\circ\text{C}$.
- 5、试验室相对湿度 (R. H IN THE CHAMBER) 85%.
- 6、压缩空气压力 (COMPRESSED AIR PRESSURE): $1.00 \pm 0.01\text{Kg/cm}^2$.
- 7、样品放置位置 (SPECIMEN SUPPORTED ANGLE): 尼龙绳吊挂 $70^\circ - 90^\circ$.
- 8、喷雾收集量 (COLLECT RATE OF SALT SOL' N) $1-2\text{mL}/(8 \text{ cm}^2\text{hr})$.
- 9、盐雾测试时间: 12小时 (H)

判定方法 (ADFUSGD METHOD)

试验后以20倍放大镜观察、无蓝、绿色腐蚀物之现象 (不包含折弯处), 即判定合格. (Inspext the ecimen at 20 xmagnification no blue or green corrosion products are acceptable)

样品序号	试验后现象	判定
	PHENOMENON AFTER TEST	COMMENT
1	无蓝、绿色腐蚀物之现象	OK
2	无蓝、绿色腐蚀物之现象	OK
3	无蓝、绿色腐蚀物之现象	OK
4	无蓝、绿色腐蚀物之现象	OK
5	无蓝、绿色腐蚀物之现象	OK

核准: 欠必锋

审核: 刘联英

试验员: 但芬

Materials Information

PRODUCT NAME: LCP M-401 BK

COMPOSITION/INFORMATION OF LCP M-401 BK

SUBSTANCE/MIXTURE: Mixture

SYNONYM(S): Aromatic Liquid Crystal Polymer(LCP)

品名	比例	用途
德众泰 LCP 树脂	0.565	构成材料主要成分
抗氧化剂	0.002	抗氧化
科莱恩热稳定剂	0.003	增加高温稳定性
黑色母	0.01	着色
滑石粉	0.2	增强剂, 增加流动性
玻纤	0.22	增强

NAME OF COMPANY: DZT Engineering Plastics Tech. Co.,Ltd

ADDRESS: Building 2 Zhichong Industrial Park, Hi-Tech Zone, Jiangmen City,
Guangdong Province, China

SECTION IN CHARGE: Quality Assurance Department

TEL/FAX: +86-750-3689920/+86-750-3689921

EMERGENCY TEL: +86-750-3689708



鉅鼎銅材廠檢驗報告單

公司名稱 Customer	鉅鼎銅材廠檢驗報告單				重量 Weight(kg)	1078	出貨日期 Date	2021/11/23		
品名 Article	標準 Standard No				尺寸 Dimension		狀態 Tenper	銅卷編號 Coil No		
C2680	JISH3100:2017				0.18*400		EH	1021-C-08		
化學成分Chemical Compositions(%)										
元素 Element	Cu %	Zn%	Pb%	Fe%	\	\	\	\	化學成分	雜質
規範 Spec	64.0-68.0	餘量	<0.05	<0.05	\	\	\	\	合格	合格
實測 Actual	64.32	餘量	0.0036	0.0136	\	\	\	\	合格	合格
機械性質Mechanical Properties										
項目 Item	結晶粒度 Grain Size Mm	硬度 Hardness Hv	抗拉強度 TensionStrength Mpa	伸長度 Elongation %	導電率 Electrical Conduc %IACS	彎曲試驗 Bending Test 180	表面粗度 Surface Roughness Ra(u m)	彎曲度 Camber mm/n		
規範MAX Spec	\	170-190	490-610	\	\	\	\	\		
實測 Actual	\	178	574	5	\	\	\	\		

品質部



Test Report

No. CANEC2222380708

Date: 26 Oct 2022

Page 1 of 6

Client Name : SHENZHEN HUALIANWEI ELECTRONICS TECHNOLOGY CO.,LTD

Client Address : 101, 201, PLANT 1, NO.307, GUANLAN GUIHUA ROAD, GUIXIANG COMMUNITY, GUANLAN SUB-DISTRICT, LONGHUA DISTRICT, SHENZHEN CITY, GUANGDONG PROVINCE, CHINA

Sample Name : LCP plastic black color

Model No. : LCP Plastic

Client Ref. Info. : Used for USB series, HDMI series, RJ series, 1394 series, MICRO series, MINI series, DISPLAYPORT series, VGA series, DVI series, TYPE-C series, JACK series

The above sample(s) and information were provided by the client.

SGS Job No. : CP22-057100 - GZ

Date of Sample Received : 20 Oct 2022

Testing Period : 20 Oct 2022 - 26 Oct 2022

Test Requested : Selected test(s) as requested by the client.

Test Method(s) : Please refer to next page(s).

Test Result(s) : Please refer to next page(s).

Result Summary :

Test Requested	Conclusion
EU RoHS Directive (EU) 2015/863 amending Annex II to Directive 2011/65/EU- Lead, Mercury, Cadmium, Hexavalent chromium, Polybrominated biphenyls (PBBs), Polybrominated diphenyl ethers (PBDEs), Bis(2-ethylhexyl) phthalate (DEHP), Butyl benzyl phthalate (BBP), Dibutyl phthalate (DBP) and Diisobutyl phthalate (DIBP)	PASS

Signed for and on behalf of
SGS-CSTC Standards Technical Services Co., Ltd. Guangzhou Branch

Dongyu Xie

Dongyu Xie
Approved Signatory

scan to see the report



689ECF7B



Test Report

No. CANEC2222380708

Date: 26 Oct 2022

Page 2 of 6

Test Result(s) :

Test Part Description :

Specimen No.	SGS Sample ID	Description
SN1	CAN22-223807.008	Black plastic

Remarks :

- (1) 1 mg/kg = 0.0001%
- (2) MDL = Method Detection Limit
- (3) ND = Not Detected (< MDL)
- (4) "-" = Not Regulated

EU RoHS Directive (EU) 2015/863 amending Annex II to Directive 2011/65/EU- Lead, Mercury, Cadmium, Hexavalent chromium, Polybrominated biphenyls (PBBs), Polybrominated diphenyl ethers (PBDEs), Bis(2-ethylhexyl) phthalate (DEHP), Butyl benzyl phthalate (BBP), Dibutyl phthalate (DBP) and Diisobutyl phthalate (DIBP)

Test Method : With reference to IEC 62321-4:2013+A1:2017, IEC 62321-5:2013, IEC 62321-7-2:2017 , IEC 62321-6:2015 and IEC 62321-8:2017, analyzed by ICP-OES , UV-Vis and GC-MS .

Test Item(s)	Limit	Unit	MDL	008
Cadmium (Cd)	100	mg/kg	2	ND
Lead (Pb)	1000	mg/kg	2	6
Mercury (Hg)	1000	mg/kg	2	ND
Hexavalent Chromium (CrVI)	1000	mg/kg	8	ND
Sum of PBBs	1000	mg/kg	-	ND
Monobromobiphenyl	-	mg/kg	5	ND
Dibromobiphenyl	-	mg/kg	5	ND
Tribromobiphenyl	-	mg/kg	5	ND
Tetrabromobiphenyl	-	mg/kg	5	ND
Pentabromobiphenyl	-	mg/kg	5	ND
Hexabromobiphenyl	-	mg/kg	5	ND
Heptabromobiphenyl	-	mg/kg	5	ND
Octabromobiphenyl	-	mg/kg	5	ND
Nonabromobiphenyl	-	mg/kg	5	ND
Decabromobiphenyl	-	mg/kg	5	ND
Sum of PBDEs	1000	mg/kg	-	ND
Monobromodiphenyl ether	-	mg/kg	5	ND
Dibromodiphenyl ether	-	mg/kg	5	ND
Tribromodiphenyl ether	-	mg/kg	5	ND
Tetrabromodiphenyl ether	-	mg/kg	5	ND



Unless otherwise agreed in writing, this document is issued by the Company subject to its General Conditions of Service printed overleaf, available on request or accessible at <http://www.sgs.com/en/Terms-and-Conditions.aspx> and, for electronic format documents, subject to Terms and Conditions for Electronic Documents at <http://www.sgs.com/en/Terms-and-Conditions/Terms-e-Documents.aspx>. Attention is drawn to the limitation of liability, indemnification and jurisdiction issues defined therein. Any holder of this document is advised that information contained hereon reflects the Company's findings at the time of its intervention only and within the limits of Client's instructions, if any. The Company's sole responsibility is to its Client and this document does not exonerate parties to a transaction from exercising all their rights and obligations under the transaction documents. This document cannot be reproduced except in full, without prior written approval of the Company. Any unauthorized alteration, forgery or falsification of the content or appearance of this document is unlawful and offenders may be prosecuted to the fullest extent of the law. Unless otherwise stated the results shown in this test report refer only to the sample(s) tested.

Attention: To check the authenticity of testing /inspection report & certificate, please contact us at telephone: (86-755) 8307 1443, or email: CN.Doccheck@sgs.com

Test Report

No. CANEC2222380708

Date: 26 Oct 2022

Page 3 of 6

<u>Test Item(s)</u>	<u>Limit</u>	<u>Unit</u>	<u>MDL</u>	<u>008</u>
Pentabromodiphenyl ether	-	mg/kg	5	ND
Hexabromodiphenyl ether	-	mg/kg	5	ND
Heptabromodiphenyl ether	-	mg/kg	5	ND
Octabromodiphenyl ether	-	mg/kg	5	ND
Nonabromodiphenyl ether	-	mg/kg	5	ND
Decabromodiphenyl ether	-	mg/kg	5	ND
Dibutyl phthalate (DBP)	1000	mg/kg	50	ND
Butyl benzyl phthalate (BBP)	1000	mg/kg	50	ND
Bis (2-ethylhexyl) phthalate (DEHP)	1000	mg/kg	50	ND
Diisobutyl Phthalates (DIBP)	1000	mg/kg	50	ND

Notes :

- (1) The maximum permissible limit is quoted from RoHS Directive (EU) 2015/863.
- (2) IEC 62321 series is equivalent to EN 62321 series
- (3) The restriction of DEHP, BBP, DBP and DIBP shall apply to medical devices, including in vitro medical devices, and monitoring and control instruments, including industrial monitoring and control instruments, from 22 July 2021.

Unless otherwise stated, the decision rule for conformity reporting is based on Binary Statement for Simple Acceptance Rule ($w=0$) stated in ILAC-G8:09/2019.



Unless otherwise agreed in writing, this document is issued by the Company subject to its General Conditions of Service printed overleaf, available on request or accessible at <http://www.sgs.com/en/Terms-and-Conditions.aspx> and, for electronic format documents, subject to Terms and Conditions for Electronic Documents at <http://www.sgs.com/en/Terms-and-Conditions/Terms-e-Documents.aspx>. Attention is drawn to the limitation of liability, indemnification and jurisdiction issues defined therein. Any holder of this document is advised that information contained hereon reflects the Company's findings at the time of its intervention only and within the limits of Client's instructions, if any. The Company's sole responsibility is to its Client and this document does not exonerate parties to a transaction from exercising all their rights and obligations under the transaction documents. This document cannot be reproduced except in full, without prior written approval of the Company. Any unauthorized alteration, forgery or falsification of the content or appearance of this document is unlawful and offenders may be prosecuted to the fullest extent of the law. Unless otherwise stated the results shown in this test report refer only to the sample(s) tested.

Attention: To check the authenticity of testing /inspection report & certificate, please contact us at telephone: (86-755) 8307 1443, or email: CN.Doccheck@sgs.com

ATTACHMENTS

Pb/Cd/Hg/Cr⁶⁺/PBBs/PBDEs Testing Flow Chart

1) These samples were dissolved totally by pre-conditioning method according to below flow chart. (Cr⁶⁺ and PBBs/PBDEs test method excluded).

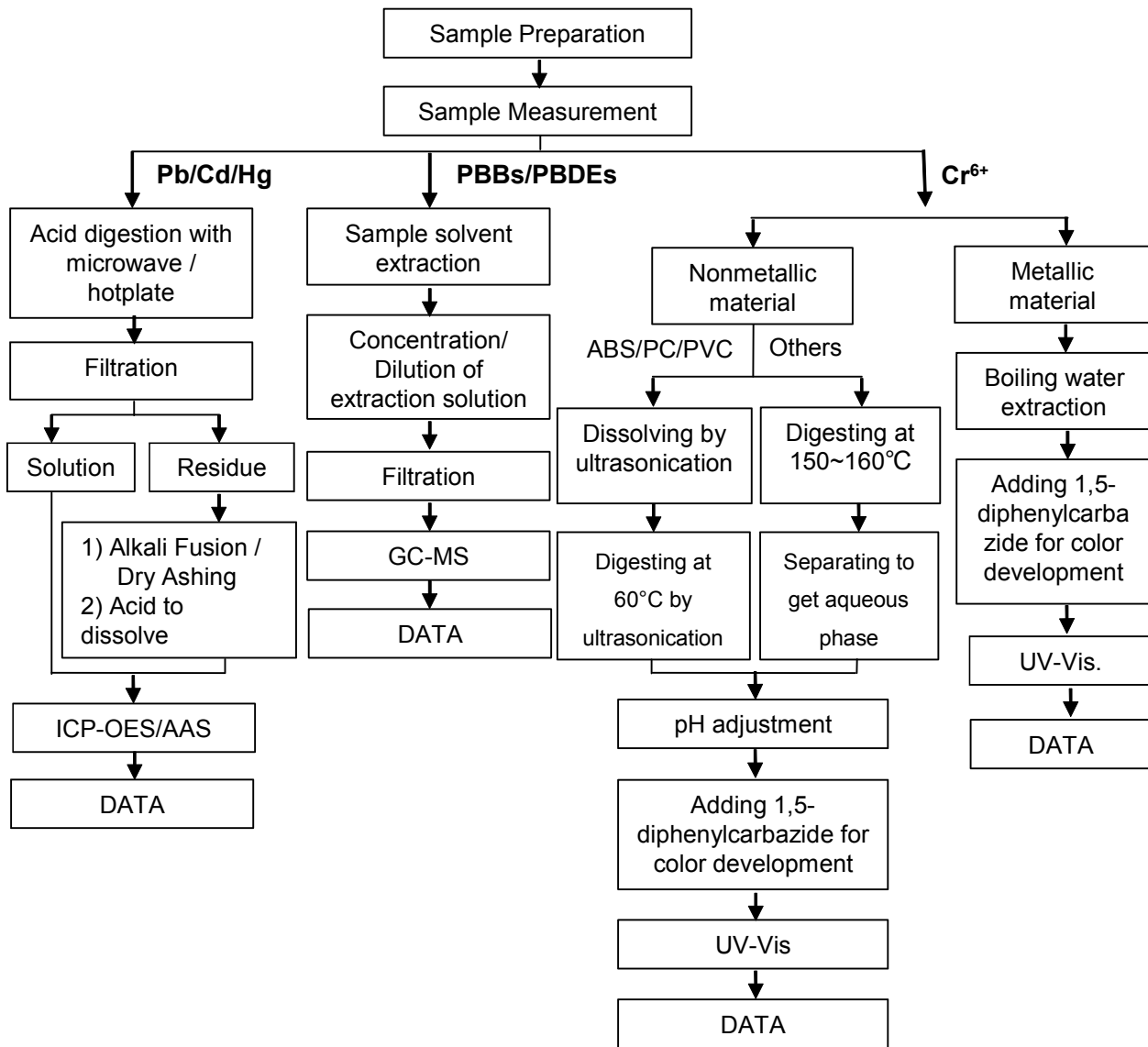

Unless otherwise agreed in writing, this document is issued by the Company subject to its General Conditions of Service printed overleaf, available on request or accessible at <http://www.sgs.com/en/Terms-and-Conditions.aspx> and, for electronic format documents, subject to Terms and Conditions for Electronic Documents at <http://www.sgs.com/en/Terms-and-Conditions/Terms-e-Documents.aspx>. Attention is drawn to the limitation of liability, indemnification and jurisdiction issues defined therein. Any holder of this document is advised that information contained hereon reflects the Company's findings at the time of its intervention only and within the limits of Client's instructions, if any. The Company's sole responsibility is to its Client and this document does not exonerate parties to a transaction from exercising all their rights and obligations under the transaction documents. This document cannot be reproduced except in full, without prior written approval of the Company. Any unauthorized alteration, forgery or falsification of the content or appearance of this document is unlawful and offenders may be prosecuted to the fullest extent of the law. Unless otherwise stated the results shown in this test report refer only to the sample(s) tested.

Attention: To check the authenticity of testing / inspection report & certificate, please contact us at telephone: (86-755) 8307 1443, or email: CN.Doccheck@sgs.com

ATTACHMENTS

Phthalates Testing Flow Chart

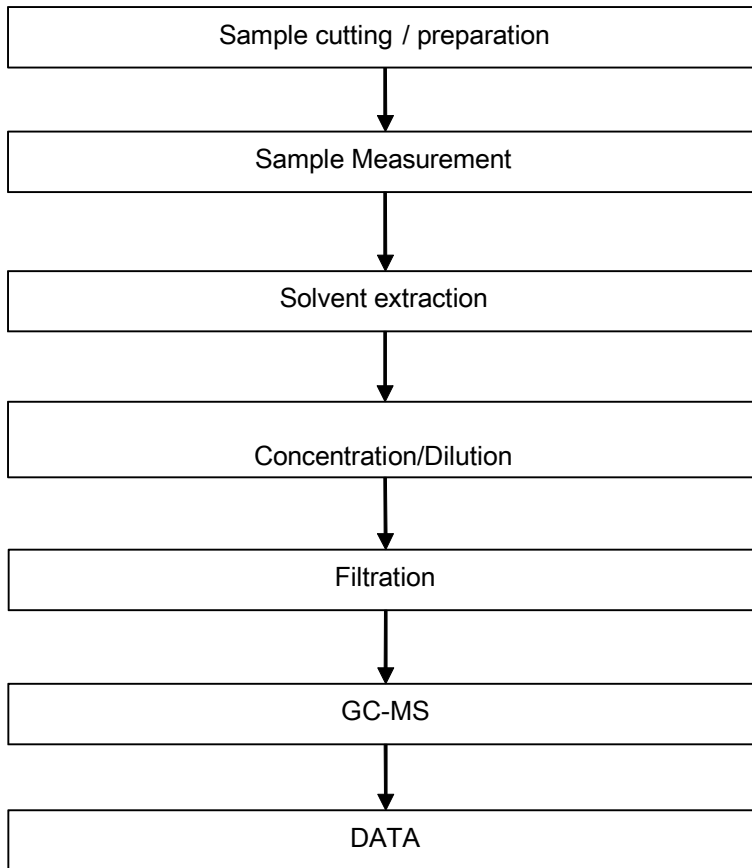

Unless otherwise agreed in writing, this document is issued by the Company subject to its General Conditions of Service printed overleaf, available on request or accessible at <http://www.sgs.com/en/Terms-and-Conditions.aspx> and, for electronic format documents, subject to Terms and Conditions for Electronic Documents at <http://www.sgs.com/en/Terms-and-Conditions/Terms-e-Document.aspx>. Attention is drawn to the limitation of liability, indemnification and jurisdiction issues defined therein. Any holder of this document is advised that information contained hereon reflects the Company's findings at the time of its intervention only and within the limits of Client's instructions, if any. The Company's sole responsibility is to its Client and this document does not exonerate parties to a transaction from exercising all their rights and obligations under the transaction documents. This document cannot be reproduced except in full, without prior written approval of the Company. Any unauthorized alteration, forgery or falsification of the content or appearance of this document is unlawful and offenders may be prosecuted to the fullest extent of the law. Unless otherwise stated the results shown in this test report refer only to the sample(s) tested.

Attention: To check the authenticity of testing / inspection report & certificate, please contact us at telephone: (86-755) 8307 1443, or email: CN_Doccheck@sgs.com

Sample photo:



SGS authenticate the photo on original report only

*** End of Report ***



Test Report

No. CANEC2222380702

Date: 26 Oct 2022

Page 1 of 4

Client Name : SHENZHEN HUALIANWEI ELECTRONICS TECHNOLOGY CO.,LTD

Client Address : 101, 201, PLANT 1, NO.307, GUANLAN GUIHUA ROAD, GUIXIANG COMMUNITY, GUANLAN SUB-DISTRICT, LONGHUA DISTRICT, SHENZHEN CITY, GUANGDONG PROVINCE, CHINA

Sample Name : C2680 Copper shell

Model No. : C2680 shell after plating

Client Ref. Info. : Used for USB series, HDMI series, RJ series, 1394 series, MICRO series, MINI series, DISPLAYPORT series, VGA series, DVI series, TYPE-C series, JACK series

The above sample(s) and information were provided by the client.

SGS Job No. : CP22-057100 - GZ

Date of Sample Received : 20 Oct 2022

Testing Period : 20 Oct 2022 - 26 Oct 2022

Test Requested : Selected test(s) as requested by the client.

Test Method(s) : Please refer to next page(s).

Test Result(s) : Please refer to next page(s).

Result Summary :

Test Requested	Conclusion
EU RoHS Directive (EU) 2015/863 amending Annex II to Directive 2011/65/EU- Lead, Mercury, Cadmium and Hexavalent chromium	PASS

Signed for and on behalf of
SGS-CSTC Standards Technical Services Co., Ltd. Guangzhou Branch

Dongyu Xie

Dongyu Xie
Approved Signatory

scan to see the report



E0D80CC0



SGS-CSTC Standards Technical Services Co., Ltd.
Guangzhou Branch Testing Center Chemical Laboratory

Unless otherwise agreed in writing, this document is issued by the Company subject to its General Conditions of Service printed overleaf, available on request or accessible at <http://www.sgs.com/en/Terms-and-Conditions.aspx> and, for electronic format documents, subject to Terms and Conditions for Electronic Documents at <http://www.sgs.com/en/Terms-and-Conditions/Terms-e-Documents.aspx>. Attention is drawn to the limitation of liability, indemnification and jurisdiction issues defined therein. Any holder of this document is advised that information contained hereon reflects the Company's findings at the time of its intervention only and within the limits of Client's instructions, if any. The Company's sole responsibility is to its Client and this document does not exonerate parties to a transaction from exercising all their rights and obligations under the transaction documents. This document cannot be reproduced except in full, without prior written approval of the Company. Any unauthorized alteration, forgery or falsification of the content or appearance of this document is unlawful and offenders may be prosecuted to the fullest extent of the law. Unless otherwise stated the results shown in this test report refer only to the sample(s) tested.

Attention: To check the authenticity of testing / inspection report & certificate, please contact us at telephone: (86-755) 8307 1443, or email: CN.Doccheck@sgs.com

198 Kazhu Road, Sciencetech Park Guangzhou Economic & Technology Development District, Guangzhou, China 510663

中国·广州·经济技术开发区科学城科珠路198号

邮编: 510663

t (86-20) 82155555

www.sgs.com

t (86-20) 82155555

sgs.china@sgs.com

Test Report

No. CANEC2222380702

Date: 26 Oct 2022

Page 2 of 4

Test Result(s) :

Test Part Description :

Specimen No.	SGS Sample ID	Description
SN1	CAN22-223807.002	Silver-grey plated metal

Remarks :

- (1) 1 mg/kg = 0.0001%
- (2) MDL = Method Detection Limit
- (3) ND = Not Detected (< MDL)
- (4) "-" = Not Regulated

EU RoHS Directive (EU) 2015/863 amending Annex II to Directive 2011/65/EU- Lead, Mercury, Cadmium and Hexavalent chromium

Test Method : With reference to IEC 62321-4:2013+A1:2017, IEC 62321-5:2013, IEC 62321-7-1:2015, analyzed by ICP-OES and UV-Vis .

<u>Test Item(s)</u>	<u>Limit</u>	<u>Unit</u>	<u>MDL</u>	<u>002</u>
Cadmium (Cd)	100	mg/kg	2	ND
Lead (Pb)	1000	mg/kg	2	37
Mercury (Hg)	1000	mg/kg	2	ND
Hexavalent Chromium (Cr(VI))▼	-	µg/cm ²	0.10	ND

Notes :

- (1) The maximum permissible limit is quoted from RoHS Directive (EU) 2015/863.
 - (2) IEC 62321 series is equivalent to EN 62321 series
 - (3) ▼= a. The sample is positive for CrVI if the CrVI concentration is greater than 0.13 µg/cm². The sample coating is considered to contain CrVI
 b. The sample is negative for CrVI if CrVI is ND (concentration less than 0.10 µg/cm²). The coating is considered a non-CrVI based coating
 c. The result between 0.10 µg/cm² and 0.13 µg/cm² is considered to be inconclusive - unavoidable coating variations may influence the determination
- Information on storage conditions and production date of the tested sample is unavailable and thus Cr(VI) results represent status of the sample at the time of testing.

Unless otherwise stated, the decision rule for conformity reporting is based on Binary Statement for Simple Acceptance Rule ($w=0$) stated in ILAC-G8:09/2019.



ATTACHMENTS

Pb/Cd/Hg/Cr⁶⁺ Testing Flow Chart

1) These samples were dissolved totally by pre-conditioning method according to below flow chart. (Cr⁶⁺ test method excluded).

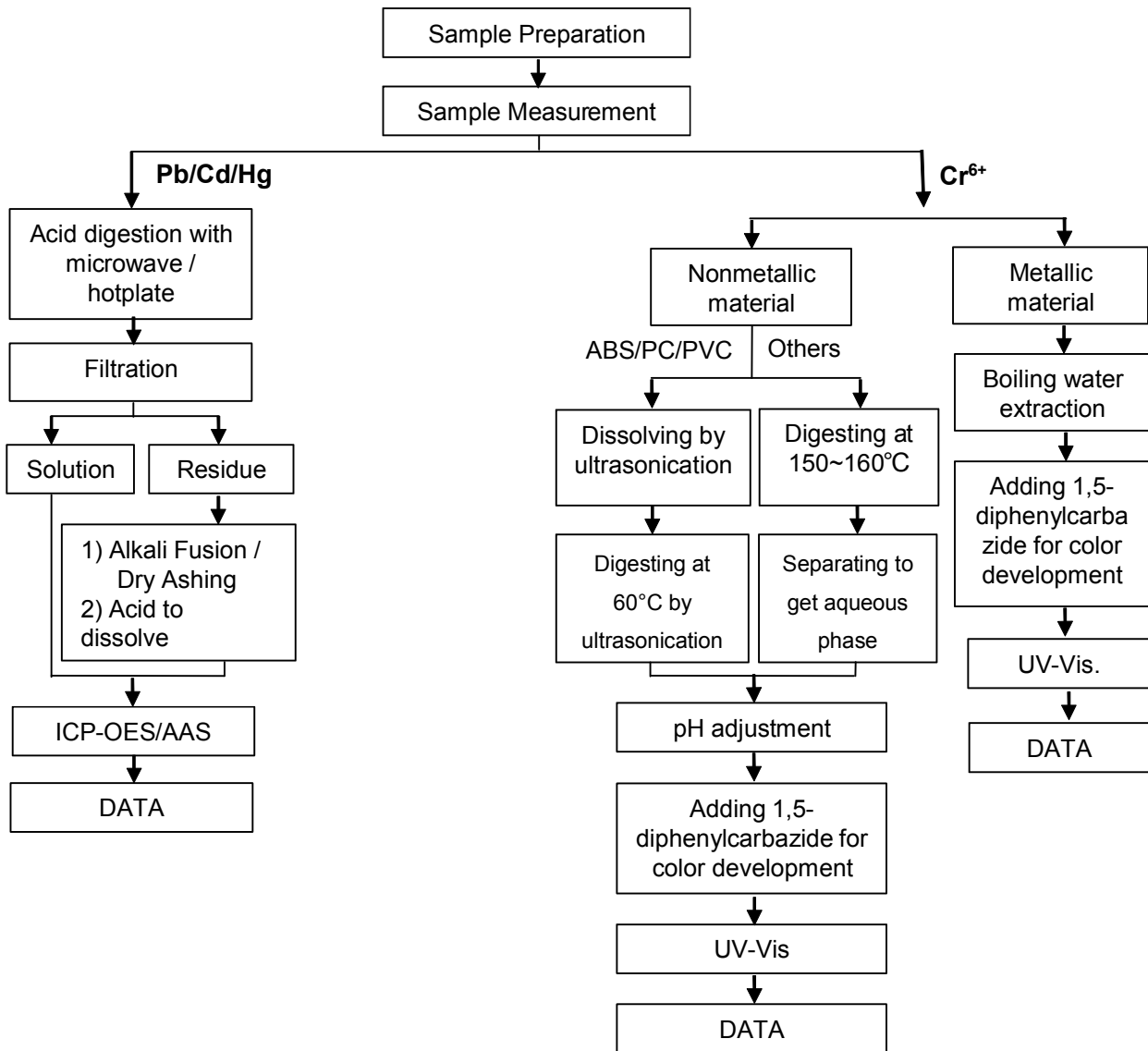

Sample photo:



SGS authenticate the photo on original report only

*** End of Report ***



Test Report

No. CANEC2222380701

Date: 26 Oct 2022

Page 1 of 4

Client Name : SHENZHEN HUALIANWEI ELECTRONICS TECHNOLOGY CO.,LTD

Client Address : 101, 201, PLANT 1, NO.307, GUANLAN GUIHUA ROAD, GUIXIANG COMMUNITY, GUANLAN SUB-DISTRICT, LONGHUA DISTRICT, SHENZHEN CITY, GUANGDONG PROVINCE, CHINA

Sample Name : C2680 Terminal

Model No. : C2680 terminal after plating

Client Ref. Info. : Used for USB series, HDMI series, RJ series, 1394 series, MICRO series, MINI series, DISPLAYPORT series, VGA series, DVI series, TYPE-C series, JACK series

The above sample(s) and information were provided by the client.

SGS Job No. : CP22-057100 - GZ

Date of Sample Received : 20 Oct 2022

Testing Period : 20 Oct 2022 - 26 Oct 2022

Test Requested : Selected test(s) as requested by the client.

Test Method(s) : Please refer to next page(s).

Test Result(s) : Please refer to next page(s).

Result Summary :

Test Requested	Conclusion
EU RoHS Directive (EU) 2015/863 amending Annex II to Directive 2011/65/EU- Lead, Mercury, Cadmium and Hexavalent chromium	PASS

Signed for and on behalf of
SGS-CSTC Standards Technical Services Co., Ltd. Guangzhou Branch

Dongyu Xie

Dongyu Xie
Approved Signatory

scan to see the report



A17521CE



Test Report

No. CANEC2222380701

Date: 26 Oct 2022

Page 2 of 4

Test Result(s) :

Test Part Description :

Specimen No.	SGS Sample ID	Description
SN1	CAN22-223807.001	Silver-grey/brassy metal

Remarks :

- (1) 1 mg/kg = 0.0001%
- (2) MDL = Method Detection Limit
- (3) ND = Not Detected (< MDL)
- (4) "-" = Not Regulated

EU RoHS Directive (EU) 2015/863 amending Annex II to Directive 2011/65/EU- Lead, Mercury, Cadmium and Hexavalent chromium

Test Method : With reference to IEC 62321-4:2013+A1:2017, IEC 62321-5:2013, IEC 62321-7-1:2015, analyzed by ICP-OES and UV-Vis .

Test Item(s)	Limit	Unit	MDL	001
Cadmium (Cd)	100	mg/kg	2	ND
Lead (Pb)	1000	mg/kg	2	3
Mercury (Hg)	1000	mg/kg	2	ND
Hexavalent Chromium (Cr(VI))▼	-	µg/cm ²	0.10	ND

Notes :

- (1) The maximum permissible limit is quoted from RoHS Directive (EU) 2015/863.
- (2) IEC 62321 series is equivalent to EN 62321 series
- (3) ▼= a. The sample is positive for CrVI if the CrVI concentration is greater than 0.13 µg/cm². The sample coating is considered to contain CrVI
 b. The sample is negative for CrVI if CrVI is ND (concentration less than 0.10 µg/cm²). The coating is considered a non-CrVI based coating
 c. The result between 0.10 µg/cm² and 0.13 µg/cm² is considered to be inconclusive - unavoidable coating variations may influence the determination
 Information on storage conditions and production date of the tested sample is unavailable and thus Cr(VI) results represent status of the sample at the time of testing.

Unless otherwise stated, the decision rule for conformity reporting is based on Binary Statement for Simple Acceptance Rule ($w=0$) stated in ILAC-G8:09/2019.



Unless otherwise agreed in writing, this document is issued by the Company subject to its General Conditions of Service printed overleaf, available on request or accessible at <http://www.sgs.com/en/Terms-and-Conditions.aspx> and, for electronic format documents, subject to Terms and Conditions for Electronic Documents at <http://www.sgs.com/en/Terms-and-Conditions/Terms-e-Documents.aspx>. Attention is drawn to the limitation of liability, indemnification and jurisdiction issues defined therein. Any holder of this document is advised that information contained hereon reflects the Company's findings at the time of its intervention only and within the limits of Client's instructions, if any. The Company's sole responsibility is to its Client and this document does not exonerate parties to a transaction from exercising all their rights and obligations under the transaction documents. This document cannot be reproduced except in full, without prior written approval of the Company. Any unauthorized alteration, forgery or falsification of the content or appearance of this document is unlawful and offenders may be prosecuted to the fullest extent of the law. Unless otherwise stated the results shown in this test report refer only to the sample(s) tested.

Attention: To check the authenticity of testing / inspection report & certificate, please contact us at telephone: (86-755) 8307 1443, or email: CN.Doccheck@sgs.com

ATTACHMENTS

Pb/Cd/Hg/Cr⁶⁺ Testing Flow Chart

1) These samples were dissolved totally by pre-conditioning method according to below flow chart. (Cr⁶⁺ test method excluded).

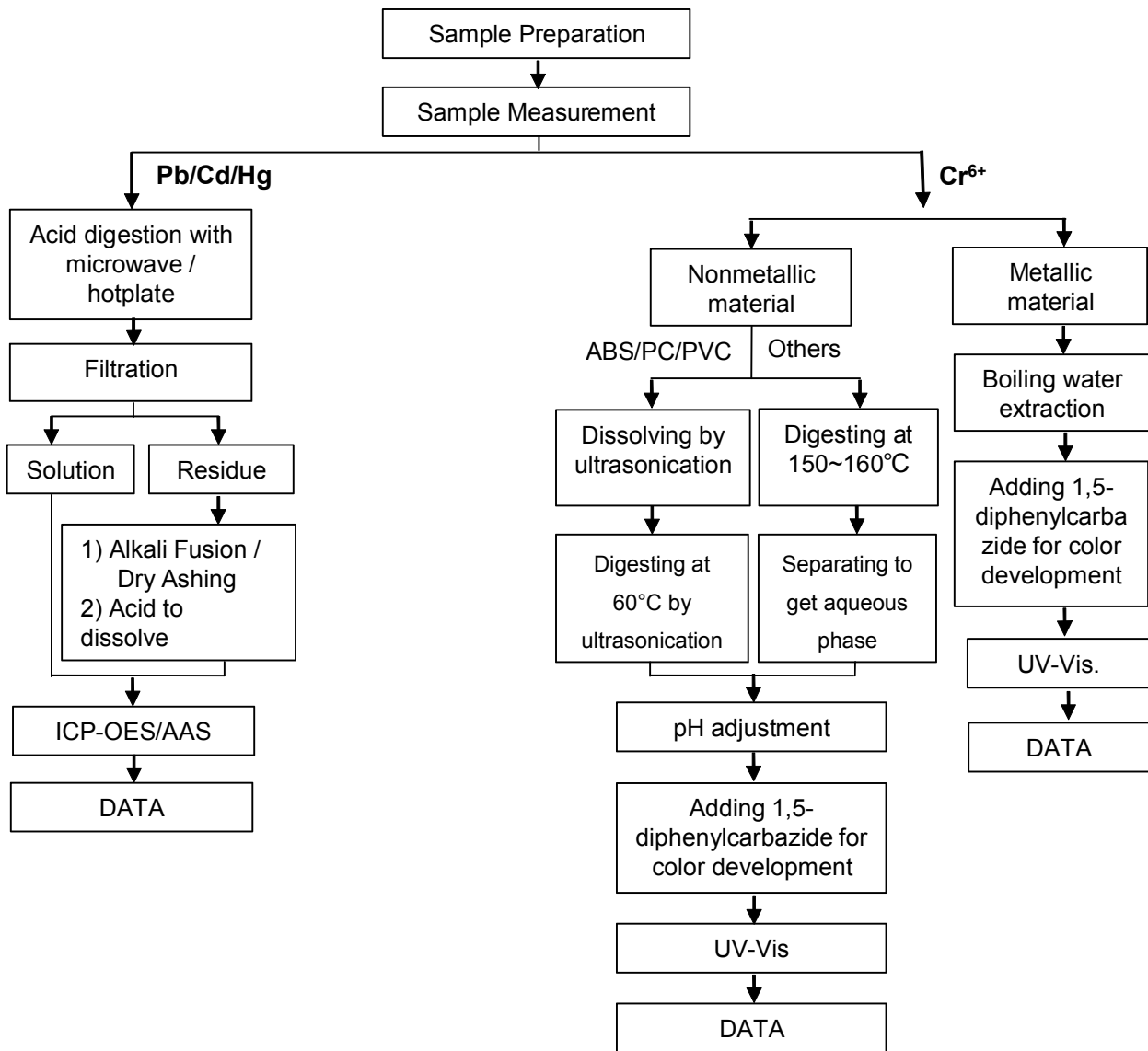

Unless otherwise agreed in writing, this document is issued by the Company subject to its General Conditions of Service printed overleaf, available on request or accessible at <http://www.sgs.com/en/Terms-and-Conditions.aspx> and, for electronic format documents, subject to Terms and Conditions for Electronic Documents at <http://www.sgs.com/en/Terms-and-Conditions/Terms-e-Documents.aspx>. Attention is drawn to the limitation of liability, indemnification and jurisdiction issues defined therein. Any holder of this document is advised that information contained hereon reflects the Company's findings at the time of its intervention only and within the limits of Client's instructions, if any. The Company's sole responsibility is to its Client and this document does not exonerate parties to a transaction from exercising all their rights and obligations under the transaction documents. This document cannot be reproduced except in full, without prior written approval of the Company. Any unauthorized alteration, forgery or falsification of the content or appearance of this document is unlawful and offenders may be prosecuted to the fullest extent of the law. Unless otherwise stated the results shown in this test report refer only to the sample(s) tested.

Attention: To check the authenticity of testing / inspection report & certificate, please contact us at telephone: (86-755) 8307 1443, or email: CN.Doccheck@sgs.com

Sample photo:



SGS authenticate the photo on original report only

*** End of Report ***



Test Report

No. CANEC2218227002

Date: 30 Aug 2022

Page 1 of 8

Client Name : SHENZHEN CITY TONGHUA INDUSTRY CO.,LTD

Client Address : TONGHUA MANSIN TONGLE XINBU VILLANG TOWN SHENZHEN CITY CHINA

Sample Name : Gold (AU)

The above sample(s) and information were provided by the client.

SGS Job No. : CP22-047169 - SZ
 Date of Sample Received : 25 Aug 2022
 Testing Period : 25 Aug 2022 - 30 Aug 2022
 Test Requested : Selected test(s) as requested by the client.
 Test Method(s) : Please refer to next page(s).
 Test Result(s) : Please refer to next page(s).

Result Summary :

Test Requested	Conclusion
EU RoHS Directive (EU) 2015/863 amending Annex II to Directive 2011/65/EU- Lead, Mercury, Cadmium, Hexavalent chromium, Polybrominated biphenyls (PBBs), Polybrominated diphenyl ethers (PBDEs), Bis(2-ethylhexyl) phthalate (DEHP), Butyl benzyl phthalate (BBP), Dibutyl phthalate (DBP) and Diisobutyl phthalate (DIBP)	PASS
Perfluorooctanoic acid (PFOA) and its salts & Perfluorooctane sulfonates (PFOS) and its derivatives	See Results

Signed for and on behalf of
 SGS-CSTC Standards Technical Services Co., Ltd. Guangzhou Branch

Dongyu Xie

Dongyu Xie
 Approved Signatory

scan to see the report



9B230D54



Test Report

No. CANEC2218227002

Date: 30 Aug 2022

Page 2 of 8

Test Result(s) :

Test Part Description :

Specimen No.	SGS Sample ID	Description
SN1	CAN22-182270.002	Gold plated metal

Remarks :

- (1) 1 mg/kg = 0.0001%
- (2) MDL = Method Detection Limit
- (3) ND = Not Detected (< MDL)
- (4) "-" = Not Regulated

EU RoHS Directive (EU) 2015/863 amending Annex II to Directive 2011/65/EU- Lead, Mercury, Cadmium, Hexavalent chromium, Polybrominated biphenyls (PBBs), Polybrominated diphenyl ethers (PBDEs), Bis(2-ethylhexyl) phthalate (DEHP), Butyl benzyl phthalate (BBP), Dibutyl phthalate (DBP) and Diisobutyl phthalate (DIBP)

Test Method : With reference to IEC 62321-4:2013+A1:2017, IEC 62321-5:2013, IEC 62321-7-1:2015 , IEC 62321-6:2015 and IEC 62321-8:2017, analyzed by ICP-OES , UV-Vis and GC-MS .

<u>Test Item(s)</u>	<u>Limit</u>	<u>Unit</u>	<u>MDL</u>	<u>002</u>
Cadmium (Cd)	100	mg/kg	2	ND
Lead (Pb)	1000	mg/kg	2	50
Mercury (Hg)	1000	mg/kg	2	ND
Hexavalent Chromium (Cr(VI))▼	-	µg/cm ²	0.10	ND
Sum of PBBs	1000	mg/kg	-	ND
Monobromobiphenyl	-	mg/kg	5	ND
Dibromobiphenyl	-	mg/kg	5	ND
Tribromobiphenyl	-	mg/kg	5	ND
Tetrabromobiphenyl	-	mg/kg	5	ND
Pentabromobiphenyl	-	mg/kg	5	ND
Hexabromobiphenyl	-	mg/kg	5	ND
Heptabromobiphenyl	-	mg/kg	5	ND
Octabromobiphenyl	-	mg/kg	5	ND
Nonabromobiphenyl	-	mg/kg	5	ND
Decabromobiphenyl	-	mg/kg	5	ND
Sum of PBDEs	1000	mg/kg	-	ND
Monobromodiphenyl ether	-	mg/kg	5	ND
Dibromodiphenyl ether	-	mg/kg	5	ND
Tribromodiphenyl ether	-	mg/kg	5	ND
Tetrabromodiphenyl ether	-	mg/kg	5	ND



Unless otherwise agreed in writing, this document is issued by the Company subject to its General Conditions of Service printed overleaf, available on request or accessible at <http://www.sgs.com/en/Terms-and-Conditions.aspx> and, for electronic format documents, subject to Terms and Conditions for Electronic Documents at <http://www.sgs.com/en/Terms-and-Conditions/Terms-e-Document.aspx>. Attention is drawn to the limitation of liability, indemnification and jurisdiction issues defined therein. Any holder of this document is advised that information contained hereon reflects the Company's findings at the time of its intervention only and within the limits of Client's instructions, if any. The Company's sole responsibility is to its Client and this document does not exonerate parties to a transaction from exercising all their rights and obligations under the transaction documents. This document cannot be reproduced except in full, without prior written approval of the Company. Any unauthorized alteration, forgery or falsification of the content or appearance of this document is unlawful and offenders may be prosecuted to the fullest extent of the law. Unless otherwise stated the results shown in this test report refer only to the sample(s) tested.

Attention: To check the authenticity of testing /inspection report & certificate, please contact us at telephone: (86-755) 8307 1443, or email: CN.Doccheck@sgs.com

Test Report

No. CANEC2218227002

Date: 30 Aug 2022

Page 3 of 8

<u>Test Item(s)</u>	<u>Limit</u>	<u>Unit</u>	<u>MDL</u>	<u>002</u>
Pentabromodiphenyl ether	-	mg/kg	5	ND
Hexabromodiphenyl ether	-	mg/kg	5	ND
Heptabromodiphenyl ether	-	mg/kg	5	ND
Octabromodiphenyl ether	-	mg/kg	5	ND
Nonabromodiphenyl ether	-	mg/kg	5	ND
Decabromodiphenyl ether	-	mg/kg	5	ND
Dibutyl phthalate (DBP)	1000	mg/kg	50	ND
Butyl benzyl phthalate (BBP)	1000	mg/kg	50	ND
Bis (2-ethylhexyl) phthalate (DEHP)	1000	mg/kg	50	ND
Diisobutyl Phthalates (DIBP)	1000	mg/kg	50	ND

Notes :

- (1) The maximum permissible limit is quoted from RoHS Directive (EU) 2015/863.
- (2) IEC 62321 series is equivalent to EN 62321 series
- (3) ▼= a. The sample is positive for CrVI if the CrVI concentration is greater than 0.13 µg/cm². The sample coating is considered to contain CrVI
 b. The sample is negative for CrVI if CrVI is ND (concentration less than 0.10 µg/cm²). The coating is considered a non-CrVI based coating
 c. The result between 0.10 µg/cm² and 0.13 µg/cm² is considered to be inconclusive - unavoidable coating variations may influence the determination
 Information on storage conditions and production date of the tested sample is unavailable and thus Cr(VI) results represent status of the sample at the time of testing.

Perfluorooctanoic acid (PFOA) and its salts & Perfluorooctane sulfonates (PFOS) and its derivatives

Test Method : With reference to CEN/TS15968:2010, analysis was performed by LC-MS or LC-MS/MS.

<u>Test Item(s)</u>	<u>CAS NO.</u>	<u>Unit</u>	<u>MDL</u>	<u>002</u>
Perfluorooctanoic acid (PFOA) and its salts+	335-67-1	mg/kg	0.010	ND
Perfluorooctane sulfonates (PFOS) ^	1763-23-1	mg/kg	0.010	ND
Perfluorooctane Sulfonamide (PFOSA)	754-91-6	mg/kg	0.010	ND
N-methylperfluoro-1-octanesulfonamide(MeFOSA)	31506-32-8	mg/kg	0.010	ND
N-ethylperfluoro-1-octanesulfonamide (EtFOSA)	4151-50-2	mg/kg	0.010	ND
2-(N-methylperfluoro-1-octanesulfonamido)-ethanol(MeFOSE)	24448-09-7	mg/kg	0.010	ND
2-(N-ethylperfluoro-1-octanesulfonamido)-ethanol(EtFOSE)	1691-99-2	mg/kg	0.010	ND
Perfluorooctane sulfonates (PFOS) and its derivatives	-	mg/kg	-	ND

Notes :



Unless otherwise agreed in writing, this document is issued by the Company subject to its General Conditions of Service printed overleaf, available on request or accessible at <http://www.sgs.com/en/Terms-and-Conditions.aspx> and, for electronic format documents, subject to Terms and Conditions for Electronic Documents at <http://www.sgs.com/en/Terms-and-Conditions/Terms-e-Document.aspx>. Attention is drawn to the limitation of liability, indemnification and jurisdiction issues defined therein. Any holder of this document is advised that information contained hereon reflects the Company's findings at the time of its intervention only and within the limits of Client's instructions, if any. The Company's sole responsibility is to its Client and this document does not exonerate parties to a transaction from exercising all their rights and obligations under the transaction documents. This document cannot be reproduced except in full, without prior written approval of the Company. Any unauthorized alteration, forgery or falsification of the content or appearance of this document is unlawful and offenders may be prosecuted to the fullest extent of the law. Unless otherwise stated the results shown in this test report refer only to the sample(s) tested.

Attention: To check the authenticity of testing /inspection report & certificate, please contact us at telephone: (86-755) 8307 1443, or email: CN.Doccheck@sgs.com

- (1) + PFOA and its salts including PFOA-Na (CAS No.: 335-95-5), PFOA-K (CAS No.: 2395-00-8), PFOA-Ag (CAS No.: 335-93-3), PFOA-F (CAS No.: 335-66-0) and APFO (CAS No.: 3825-26-1);
- (2) ^ PFOS including PFOS-K (CAS No.: 2795-39-3), PFOS-Li (CAS No.: 29457-72-5), PFOS-NH₄ (CAS No.: 29081-56-9), PFOS-NH(OH)₂ (CAS No.: 70225-14-8), PFOS-N(C₂H₅)₄ (CAS No.: 56773-42-3), PFOS-DDA(CAS No.:251099-16-8) and POSF (CAS No.: 307-35-7)

Unless otherwise stated, the decision rule for conformity reporting is based on Binary Statement for Simple Acceptance Rule ($w=0$) stated in ILAC-G8:09/2019.



ATTACHMENTS

Pb/Cd/Hg/Cr⁶⁺/PBBs/PBDEs Testing Flow Chart

1) These samples were dissolved totally by pre-conditioning method according to below flow chart. (Cr⁶⁺ and PBBs/PBDEs test method excluded).

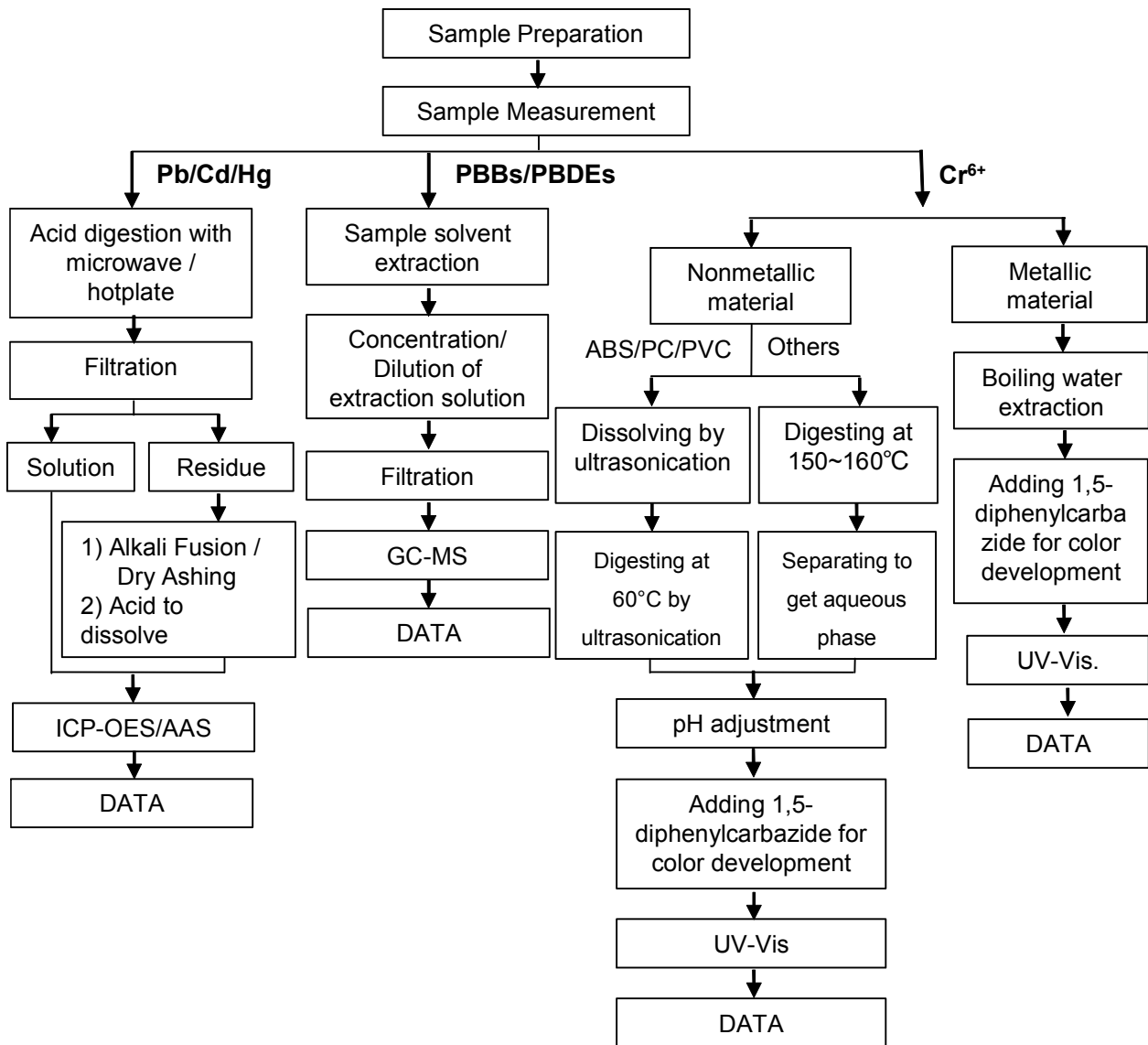

Unless otherwise agreed in writing, this document is issued by the Company subject to its General Conditions of Service printed overleaf, available on request or accessible at <http://www.sgs.com/en/Terms-and-Conditions.aspx> and, for electronic format documents, subject to Terms and Conditions for Electronic Documents at <http://www.sgs.com/en/Terms-and-Conditions/Terms-e-Documents.aspx>. Attention is drawn to the limitation of liability, indemnification and jurisdiction issues defined therein. Any holder of this document is advised that information contained hereon reflects the Company's findings at the time of its intervention only and within the limits of Client's instructions, if any. The Company's sole responsibility is to its Client and this document does not exonerate parties to a transaction from exercising all their rights and obligations under the transaction documents. This document cannot be reproduced except in full, without prior written approval of the Company. Any unauthorized alteration, forgery or falsification of the content or appearance of this document is unlawful and offenders may be prosecuted to the fullest extent of the law. Unless otherwise stated the results shown in this test report refer only to the sample(s) tested.

Attention: To check the authenticity of testing / inspection report & certificate, please contact us at telephone: (86-755) 8307 1443, or email: CN.Doccheck@sgs.com

ATTACHMENTS

Phthalates Testing Flow Chart

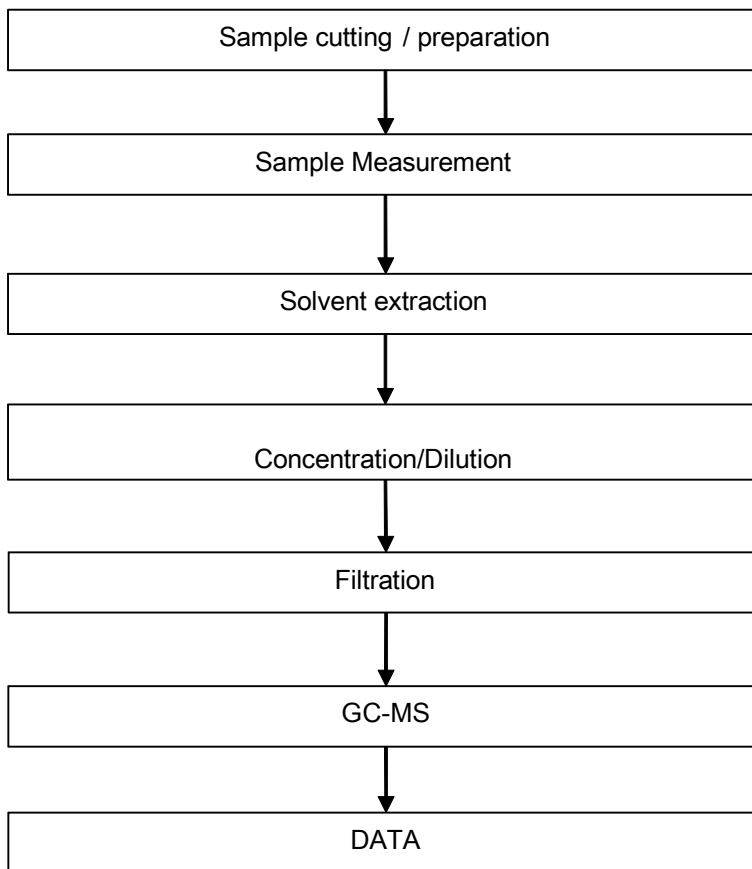

Unless otherwise agreed in writing, this document is issued by the Company subject to its General Conditions of Service printed overleaf, available on request or accessible at <http://www.sgs.com/en/Terms-and-Conditions.aspx> and, for electronic format documents, subject to Terms and Conditions for Electronic Documents at <http://www.sgs.com/en/Terms-and-Conditions/Terms-e-Document.aspx>. Attention is drawn to the limitation of liability, indemnification and jurisdiction issues defined therein. Any holder of this document is advised that information contained hereon reflects the Company's findings at the time of its intervention only and within the limits of Client's instructions, if any. The Company's sole responsibility is to its Client and this document does not exonerate parties to a transaction from exercising all their rights and obligations under the transaction documents. This document cannot be reproduced except in full, without prior written approval of the Company. Any unauthorized alteration, forgery or falsification of the content or appearance of this document is unlawful and offenders may be prosecuted to the fullest extent of the law. Unless otherwise stated the results shown in this test report refer only to the sample(s) tested.

Attention: To check the authenticity of testing / inspection report & certificate, please contact us at telephone: (86-755) 8307 1443, or email: CN_Doccheck@sgs.com

ATTACHMENTS

PFOA / PFOS Testing Flow Chart

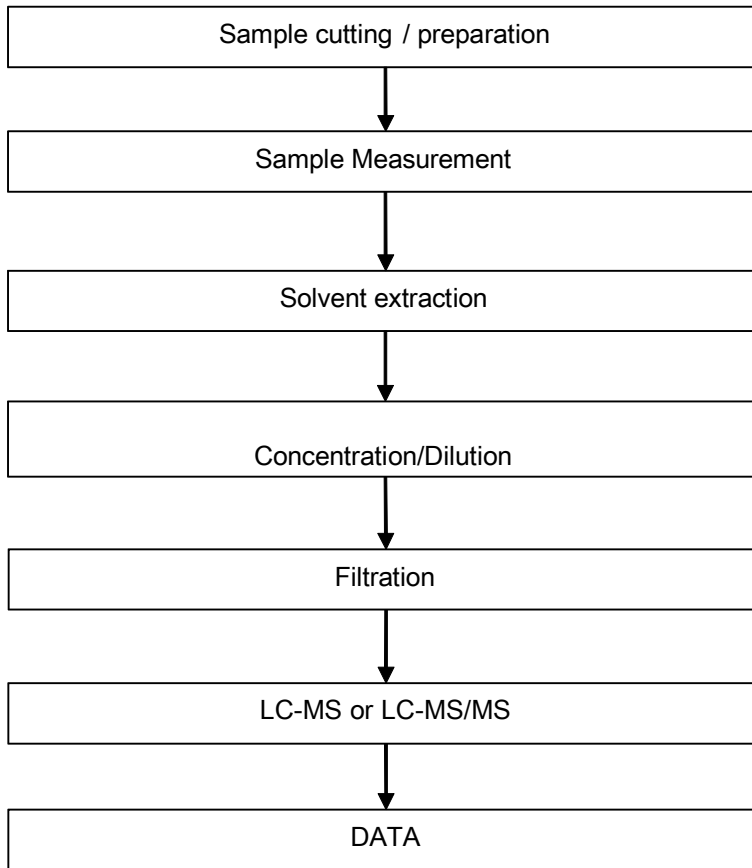

Unless otherwise agreed in writing, this document is issued by the Company subject to its General Conditions of Service printed overleaf, available on request or accessible at <http://www.sgs.com/en/Terms-and-Conditions.aspx> and, for electronic format documents, subject to Terms and Conditions for Electronic Documents at <http://www.sgs.com/en/Terms-and-Conditions/Terms-e-Document.aspx>. Attention is drawn to the limitation of liability, indemnification and jurisdiction issues defined therein. Any holder of this document is advised that information contained hereon reflects the Company's findings at the time of its intervention only and within the limits of Client's instructions, if any. The Company's sole responsibility is to its Client and this document does not exonerate parties to a transaction from exercising all their rights and obligations under the transaction documents. This document cannot be reproduced except in full, without prior written approval of the Company. Any unauthorized alteration, forgery or falsification of the content or appearance of this document is unlawful and offenders may be prosecuted to the fullest extent of the law. Unless otherwise stated the results shown in this test report refer only to the sample(s) tested.

Attention: To check the authenticity of testing / inspection report & certificate, please contact us at telephone: (86-755) 8307 1443, or email: CN_Doccheck@sgs.com

Sample photo:



SGS authenticate the photo on original report only

*** End of Report ***



Test Report

No. CANEC2218227001

Date: 30 Aug 2022

Page 1 of 8

Client Name : SHENZHEN CITY TONGHUA INDUSTRY CO.,LTD

Client Address : TONGHUA MANSIN TONGLE XINBU VILLANG TOWN SHENZHEN CITY CHINA

Sample Name : Nickel(Ni)

The above sample(s) and information were provided by the client.

SGS Job No. : CP22-047169 - SZ
 Date of Sample Received : 25 Aug 2022
 Testing Period : 25 Aug 2022 - 30 Aug 2022
 Test Requested : Selected test(s) as requested by the client.
 Test Method(s) : Please refer to next page(s).
 Test Result(s) : Please refer to next page(s).

Result Summary :

Test Requested	Conclusion
EU RoHS Directive (EU) 2015/863 amending Annex II to Directive 2011/65/EU- Lead, Mercury, Cadmium, Hexavalent chromium, Polybrominated biphenyls (PBBs), Polybrominated diphenyl ethers (PBDEs), Bis(2-ethylhexyl) phthalate (DEHP), Butyl benzyl phthalate (BBP), Dibutyl phthalate (DBP) and Diisobutyl phthalate (DIBP)	PASS
Perfluorooctanoic acid (PFOA) and its salts & Perfluorooctane sulfonates (PFOS) and its derivatives	See Results

Signed for and on behalf of
 SGS-CSTC Standards Technical Services Co., Ltd. Guangzhou Branch

Dongyu Xie

Dongyu Xie
 Approved Signatory

scan to see the report



5753937E



Test Report

No. CANEC2218227001

Date: 30 Aug 2022

Page 2 of 8

Test Result(s) :

Test Part Description :

Specimen No.	SGS Sample ID	Description
SN1	CAN22-182270.001	Silver-gray plated metal

Remarks :

- (1) 1 mg/kg = 0.0001%
- (2) MDL = Method Detection Limit
- (3) ND = Not Detected (< MDL)
- (4) "-" = Not Regulated

EU RoHS Directive (EU) 2015/863 amending Annex II to Directive 2011/65/EU- Lead, Mercury, Cadmium, Hexavalent chromium, Polybrominated biphenyls (PBBs), Polybrominated diphenyl ethers (PBDEs), Bis(2-ethylhexyl) phthalate (DEHP), Butyl benzyl phthalate (BBP), Dibutyl phthalate (DBP) and Diisobutyl phthalate (DIBP)

Test Method : With reference to IEC 62321-4:2013+A1:2017, IEC 62321-5:2013, IEC 62321-7-1:2015 , IEC 62321-6:2015 and IEC 62321-8:2017, analyzed by ICP-OES , UV-Vis and GC-MS .

Test Item(s)	Limit	Unit	MDL	001
Cadmium (Cd)	100	mg/kg	2	ND
Lead (Pb)	1000	mg/kg	2	49
Mercury (Hg)	1000	mg/kg	2	ND
Hexavalent Chromium (Cr(VI))▼	-	µg/cm ²	0.10	ND
Sum of PBBs	1000	mg/kg	-	ND
Monobromobiphenyl	-	mg/kg	5	ND
Dibromobiphenyl	-	mg/kg	5	ND
Tribromobiphenyl	-	mg/kg	5	ND
Tetrabromobiphenyl	-	mg/kg	5	ND
Pentabromobiphenyl	-	mg/kg	5	ND
Hexabromobiphenyl	-	mg/kg	5	ND
Heptabromobiphenyl	-	mg/kg	5	ND
Octabromobiphenyl	-	mg/kg	5	ND
Nonabromobiphenyl	-	mg/kg	5	ND
Decabromobiphenyl	-	mg/kg	5	ND
Sum of PBDEs	1000	mg/kg	-	ND
Monobromodiphenyl ether	-	mg/kg	5	ND
Dibromodiphenyl ether	-	mg/kg	5	ND
Tribromodiphenyl ether	-	mg/kg	5	ND
Tetrabromodiphenyl ether	-	mg/kg	5	ND



Unless otherwise agreed in writing, this document is issued by the Company subject to its General Conditions of Service printed overleaf, available on request or accessible at <http://www.sgs.com/en/Terms-and-Conditions.aspx> and, for electronic format documents, subject to Terms and Conditions for Electronic Documents at <http://www.sgs.com/en/Terms-and-Conditions/Terms-e-Documents.aspx>. Attention is drawn to the limitation of liability, indemnification and jurisdiction issues defined therein. Any holder of this document is advised that information contained hereon reflects the Company's findings at the time of its intervention only and within the limits of Client's instructions, if any. The Company's sole responsibility is to its Client and this document does not exonerate parties to a transaction from exercising all their rights and obligations under the transaction documents. This document cannot be reproduced except in full, without prior written approval of the Company. Any unauthorized alteration, forgery or falsification of the content or appearance of this document is unlawful and offenders may be prosecuted to the fullest extent of the law. Unless otherwise stated the results shown in this test report refer only to the sample(s) tested.

Attention: To check the authenticity of testing /inspection report & certificate, please contact us at telephone: (86-755) 8307 1443, or email: CN.Doccheck@sgs.com

Test Report

No. CANEC2218227001

Date: 30 Aug 2022

Page 3 of 8

<u>Test Item(s)</u>	<u>Limit</u>	<u>Unit</u>	<u>MDL</u>	<u>001</u>
Pentabromodiphenyl ether	-	mg/kg	5	ND
Hexabromodiphenyl ether	-	mg/kg	5	ND
Heptabromodiphenyl ether	-	mg/kg	5	ND
Octabromodiphenyl ether	-	mg/kg	5	ND
Nonabromodiphenyl ether	-	mg/kg	5	ND
Decabromodiphenyl ether	-	mg/kg	5	ND
Dibutyl phthalate (DBP)	1000	mg/kg	50	ND
Butyl benzyl phthalate (BBP)	1000	mg/kg	50	ND
Bis (2-ethylhexyl) phthalate (DEHP)	1000	mg/kg	50	ND
Diisobutyl Phthalates (DIBP)	1000	mg/kg	50	ND

Notes :

- (1) The maximum permissible limit is quoted from RoHS Directive (EU) 2015/863.
- (2) IEC 62321 series is equivalent to EN 62321 series
- (3) ▼= a. The sample is positive for CrVI if the CrVI concentration is greater than 0.13 µg/cm². The sample coating is considered to contain CrVI
 b. The sample is negative for CrVI if CrVI is ND (concentration less than 0.10 µg/cm²). The coating is considered a non-CrVI based coating
 c. The result between 0.10 µg/cm² and 0.13 µg/cm² is considered to be inconclusive - unavoidable coating variations may influence the determination
 Information on storage conditions and production date of the tested sample is unavailable and thus Cr(VI) results represent status of the sample at the time of testing.

Perfluorooctanoic acid (PFOA) and its salts & Perfluorooctane sulfonates (PFOS) and its derivatives

Test Method : With reference to CEN/TS15968:2010, analysis was performed by LC-MS or LC-MS/MS.

<u>Test Item(s)</u>	<u>CAS NO.</u>	<u>Unit</u>	<u>MDL</u>	<u>001</u>
Perfluorooctanoic acid (PFOA) and its salts+	335-67-1	mg/kg	0.010	ND
Perfluorooctane sulfonates (PFOS) ^	1763-23-1	mg/kg	0.010	ND
Perfluorooctane Sulfonamide (PFOSA)	754-91-6	mg/kg	0.010	ND
N-methylperfluoro-1-octanesulfonamide(MeFOSA)	31506-32-8	mg/kg	0.010	ND
N-ethylperfluoro-1-octanesulfonamide (EtFOSA)	4151-50-2	mg/kg	0.010	ND
2-(N-methylperfluoro-1-octanesulfonamido)-ethanol(MeFOSE)	24448-09-7	mg/kg	0.010	ND
2-(N-ethylperfluoro-1-octanesulfonamido)-ethanol(EtFOSE)	1691-99-2	mg/kg	0.010	ND
Perfluorooctane sulfonates (PFOS) and its derivatives	-	mg/kg	-	ND

Notes :



Unless otherwise agreed in writing, this document is issued by the Company subject to its General Conditions of Service printed overleaf, available on request or accessible at <http://www.sgs.com/en/Terms-and-Conditions.aspx> and, for electronic format documents, subject to Terms and Conditions for Electronic Documents at <http://www.sgs.com/en/Terms-and-Conditions/Terms-e-Document.aspx>. Attention is drawn to the limitation of liability, indemnification and jurisdiction issues defined therein. Any holder of this document is advised that information contained hereon reflects the Company's findings at the time of its intervention only and within the limits of Client's instructions, if any. The Company's sole responsibility is to its Client and this document does not exonerate parties to a transaction from exercising all their rights and obligations under the transaction documents. This document cannot be reproduced except in full, without prior written approval of the Company. Any unauthorized alteration, forgery or falsification of the content or appearance of this document is unlawful and offenders may be prosecuted to the fullest extent of the law. Unless otherwise stated the results shown in this test report refer only to the sample(s) tested.

Attention: To check the authenticity of testing /inspection report & certificate, please contact us at telephone: (86-755) 8307 1443, or email: CN.Doccheck@sgs.com

- (1) + PFOA and its salts including PFOA-Na (CAS No.: 335-95-5), PFOA-K (CAS No.: 2395-00-8), PFOA-Ag (CAS No.: 335-93-3), PFOA-F (CAS No.: 335-66-0) and APFO (CAS No.: 3825-26-1);
- (2) ^ PFOS including PFOS-K (CAS No.: 2795-39-3), PFOS-Li (CAS No.: 29457-72-5), PFOS-NH₄ (CAS No.: 29081-56-9), PFOS-NH(OH)₂ (CAS No.: 70225-14-8), PFOS-N(C₂H₅)₄ (CAS No.: 56773-42-3), PFOS-DDA (CAS No.: 251099-16-8) and POSF (CAS No.: 307-35-7)

Unless otherwise stated, the decision rule for conformity reporting is based on Binary Statement for Simple Acceptance Rule ($w=0$) stated in ILAC-G8:09/2019.



Unless otherwise agreed in writing, this document is issued by the Company subject to its General Conditions of Service printed overleaf, available on request or accessible at <http://www.sgs.com/en/Terms-and-Conditions.aspx> and, for electronic format documents, subject to Terms and Conditions for Electronic Documents at <http://www.sgs.com/en/Terms-and-Conditions/Terms-e-Documents.aspx>. Attention is drawn to the limitation of liability, indemnification and jurisdiction issues defined therein. Any holder of this document is advised that information contained hereon reflects the Company's findings at the time of its intervention only and within the limits of Client's instructions, if any. The Company's sole responsibility is to its Client and this document does not exonerate parties to a transaction from exercising all their rights and obligations under the transaction documents. This document cannot be reproduced except in full, without prior written approval of the Company. Any unauthorized alteration, forgery or falsification of the content or appearance of this document is unlawful and offenders may be prosecuted to the fullest extent of the law. Unless otherwise stated the results shown in this test report refer only to the sample(s) tested.

Attention: To check the authenticity of testing / inspection report & certificate, please contact us at telephone: (86-755) 8307 1443, or email: CN.Doccheck@sgs.com

ATTACHMENTS

Pb/Cd/Hg/Cr⁶⁺/PBBs/PBDEs Testing Flow Chart

1) These samples were dissolved totally by pre-conditioning method according to below flow chart. (Cr⁶⁺ and PBBs/PBDEs test method excluded).

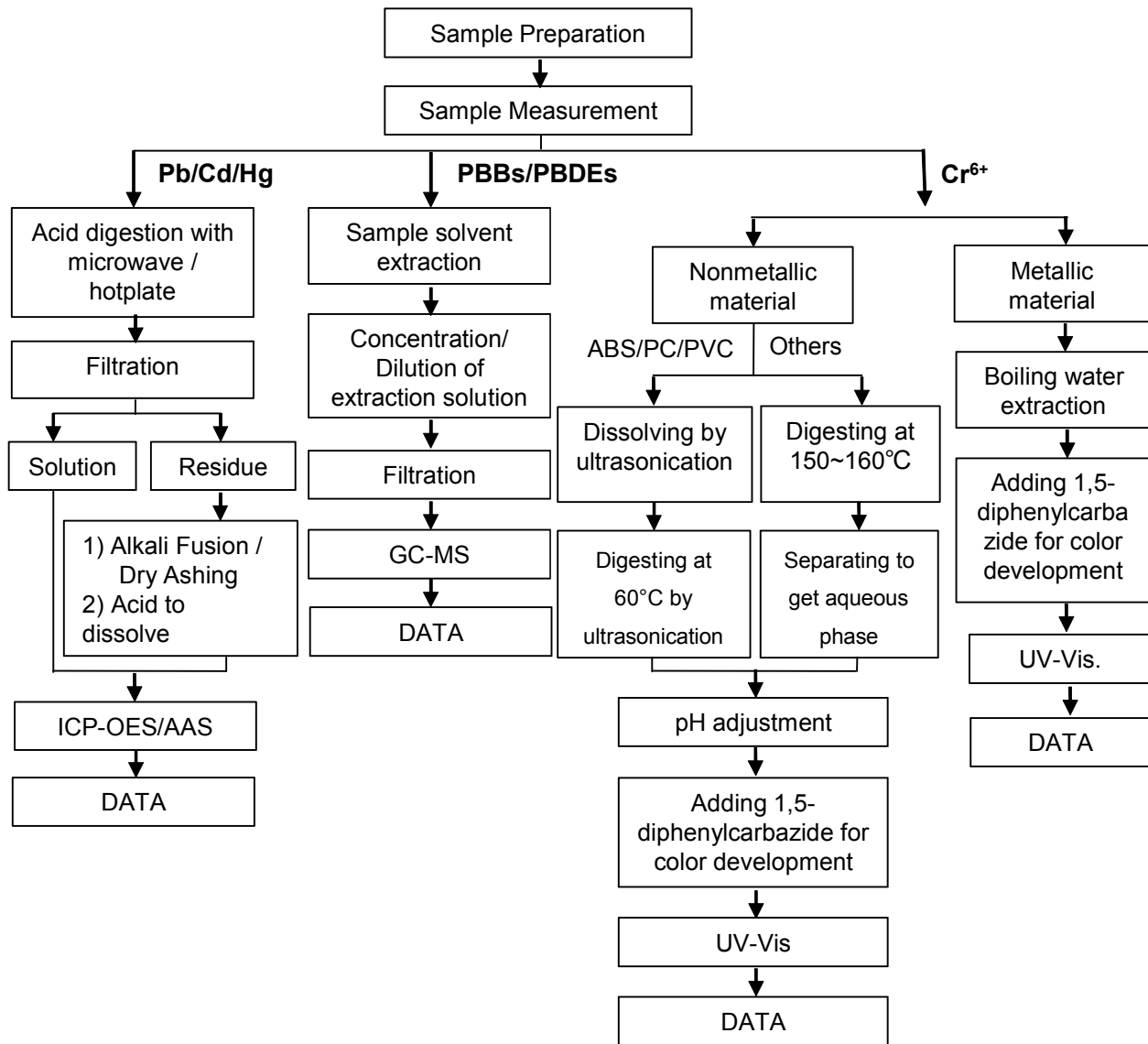

ATTACHMENTS

Phthalates Testing Flow Chart

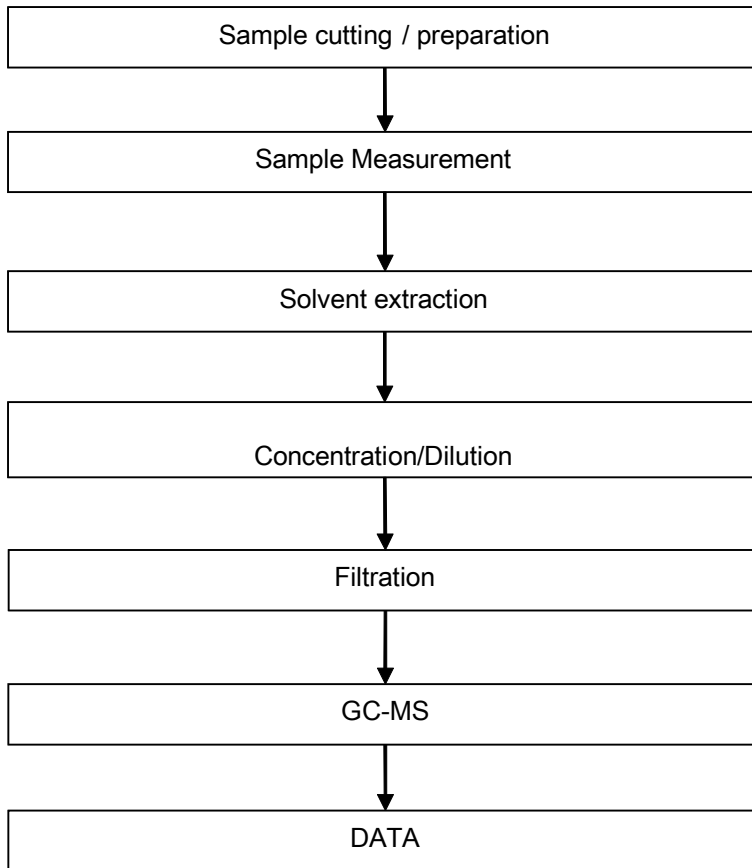

Unless otherwise agreed in writing, this document is issued by the Company subject to its General Conditions of Service printed overleaf, available on request or accessible at <http://www.sgs.com/en/Terms-and-Conditions.aspx> and, for electronic format documents, subject to Terms and Conditions for Electronic Documents at <http://www.sgs.com/en/Terms-and-Conditions/Terms-e-Document.aspx>. Attention is drawn to the limitation of liability, indemnification and jurisdiction issues defined therein. Any holder of this document is advised that information contained hereon reflects the Company's findings at the time of its intervention only and within the limits of Client's instructions, if any. The Company's sole responsibility is to its Client and this document does not exonerate parties to a transaction from exercising all their rights and obligations under the transaction documents. This document cannot be reproduced except in full, without prior written approval of the Company. Any unauthorized alteration, forgery or falsification of the content or appearance of this document is unlawful and offenders may be prosecuted to the fullest extent of the law. Unless otherwise stated the results shown in this test report refer only to the sample(s) tested.

Attention: To check the authenticity of testing / inspection report & certificate, please contact us at telephone: (86-755) 8307 1443, or email: CN.Doccheck@sgs.com

ATTACHMENTS

PFOA / PFOS Testing Flow Chart

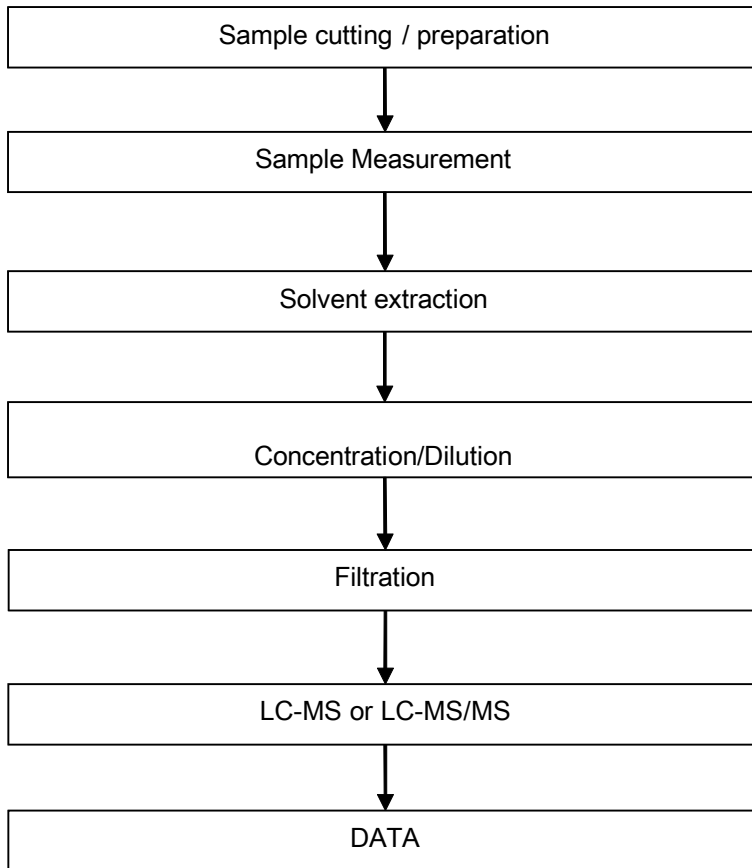

Unless otherwise agreed in writing, this document is issued by the Company subject to its General Conditions of Service printed overleaf, available on request or accessible at <http://www.sgs.com/en/Terms-and-Conditions.aspx> and, for electronic format documents, subject to Terms and Conditions for Electronic Documents at <http://www.sgs.com/en/Terms-and-Conditions/Terms-e-Document.aspx>. Attention is drawn to the limitation of liability, indemnification and jurisdiction issues defined therein. Any holder of this document is advised that information contained hereon reflects the Company's findings at the time of its intervention only and within the limits of Client's instructions, if any. The Company's sole responsibility is to its Client and this document does not exonerate parties to a transaction from exercising all their rights and obligations under the transaction documents. This document cannot be reproduced except in full, without prior written approval of the Company. Any unauthorized alteration, forgery or falsification of the content or appearance of this document is unlawful and offenders may be prosecuted to the fullest extent of the law. Unless otherwise stated the results shown in this test report refer only to the sample(s) tested.

Attention: To check the authenticity of testing / inspection report & certificate, please contact us at telephone: (86-755) 8307 1443, or email: CN.Doccheck@sgs.com

Sample photo:



SGS authenticate the photo on original report only

*** End of Report ***



Test Report

No. CANEC2218227003

Date: 30 Aug 2022

Page 1 of 8

Client Name : SHENZHEN CITY TONGHUA INDUSTRY CO.,LTD

Client Address : TONGHUA MANSIN TONGLE XINBU VILLANG TOWN SHENZHEN CITY CHINA

Sample Name : Bright Tin(SN)

The above sample(s) and information were provided by the client.

SGS Job No. : CP22-047169 - SZ
 Date of Sample Received : 25 Aug 2022
 Testing Period : 25 Aug 2022 - 30 Aug 2022
 Test Requested : Selected test(s) as requested by the client.
 Test Method(s) : Please refer to next page(s).
 Test Result(s) : Please refer to next page(s).

Result Summary :

Test Requested	Conclusion
EU RoHS Directive (EU) 2015/863 amending Annex II to Directive 2011/65/EU- Lead, Mercury, Cadmium, Hexavalent chromium, Polybrominated biphenyls (PBBs), Polybrominated diphenyl ethers (PBDEs), Bis(2-ethylhexyl) phthalate (DEHP), Butyl benzyl phthalate (BBP), Dibutyl phthalate (DBP) and Diisobutyl phthalate (DIBP)	PASS
Perfluorooctanoic acid (PFOA) and its salts & Perfluorooctane sulfonates (PFOS) and its derivatives	See Results

Signed for and on behalf of
 SGS-CSTC Standards Technical Services Co., Ltd. Guangzhou Branch

Dongyu Xie

Dongyu Xie
 Approved Signatory

scan to see the report



87F8007D



Unless otherwise agreed in writing, this document is issued by the Company subject to its General Conditions of Service printed overleaf, available on request or accessible at <http://www.sgs.com/en/Terms-and-Conditions.aspx> and, for electronic format documents, subject to Terms and Conditions for Electronic Documents at <http://www.sgs.com/en/Terms-and-Conditions/Terms-e-Documents.aspx>. Attention is drawn to the limitation of liability, indemnification and jurisdiction issues defined therein. Any holder of this document is advised that information contained hereon reflects the Company's findings at the time of its intervention only and within the limits of Client's instructions, if any. The Company's sole responsibility is to its Client and this document does not exonerate parties to a transaction from exercising all their rights and obligations under the transaction documents. This document cannot be reproduced except in full, without prior written approval of the Company. Any unauthorized alteration, forgery or falsification of the content or appearance of this document is unlawful and offenders may be prosecuted to the fullest extent of the law. Unless otherwise stated the results shown in this test report refer only to the sample(s) tested.

Attention: To check the authenticity of testing / inspection report & certificate, please contact us at telephone: (86-755) 8307 1443, or email: CN.Doccheck@sgs.com

Test Report

No. CANEC2218227003

Date: 30 Aug 2022

Page 2 of 8

Test Result(s) :

Test Part Description :

Specimen No.	SGS Sample ID	Description
SN1	CAN22-182270.003	Silver-gray plated metal

Remarks :

- (1) 1 mg/kg = 0.0001%
- (2) MDL = Method Detection Limit
- (3) ND = Not Detected (< MDL)
- (4) "-" = Not Regulated

EU RoHS Directive (EU) 2015/863 amending Annex II to Directive 2011/65/EU- Lead, Mercury, Cadmium, Hexavalent chromium, Polybrominated biphenyls (PBBs), Polybrominated diphenyl ethers (PBDEs), Bis(2-ethylhexyl) phthalate (DEHP), Butyl benzyl phthalate (BBP), Dibutyl phthalate (DBP) and Diisobutyl phthalate (DIBP)

Test Method : With reference to IEC 62321-4:2013+A1:2017, IEC 62321-5:2013, IEC 62321-7-1:2015 , IEC 62321-6:2015 and IEC 62321-8:2017, analyzed by ICP-OES , UV-Vis and GC-MS .

<u>Test Item(s)</u>	<u>Limit</u>	<u>Unit</u>	<u>MDL</u>	<u>003</u>
Cadmium (Cd)	100	mg/kg	2	ND
Lead (Pb)	1000	mg/kg	2	44
Mercury (Hg)	1000	mg/kg	2	ND
Hexavalent Chromium (Cr(VI))▼	-	µg/cm ²	0.10	ND
Sum of PBBs	1000	mg/kg	-	ND
Monobromobiphenyl	-	mg/kg	5	ND
Dibromobiphenyl	-	mg/kg	5	ND
Tribromobiphenyl	-	mg/kg	5	ND
Tetrabromobiphenyl	-	mg/kg	5	ND
Pentabromobiphenyl	-	mg/kg	5	ND
Hexabromobiphenyl	-	mg/kg	5	ND
Heptabromobiphenyl	-	mg/kg	5	ND
Octabromobiphenyl	-	mg/kg	5	ND
Nonabromobiphenyl	-	mg/kg	5	ND
Decabromobiphenyl	-	mg/kg	5	ND
Sum of PBDEs	1000	mg/kg	-	ND
Monobromodiphenyl ether	-	mg/kg	5	ND
Dibromodiphenyl ether	-	mg/kg	5	ND
Tribromodiphenyl ether	-	mg/kg	5	ND
Tetrabromodiphenyl ether	-	mg/kg	5	ND



Unless otherwise agreed in writing, this document is issued by the Company subject to its General Conditions of Service printed overleaf, available on request or accessible at <http://www.sgs.com/en/Terms-and-Conditions.aspx> and, for electronic format documents, subject to Terms and Conditions for Electronic Documents at <http://www.sgs.com/en/Terms-and-Conditions/Terms-e-Documents.aspx>. Attention is drawn to the limitation of liability, indemnification and jurisdiction issues defined therein. Any holder of this document is advised that information contained hereon reflects the Company's findings at the time of its intervention only and within the limits of Client's instructions, if any. The Company's sole responsibility is to its Client and this document does not exonerate parties to a transaction from exercising all their rights and obligations under the transaction documents. This document cannot be reproduced except in full, without prior written approval of the Company. Any unauthorized alteration, forgery or falsification of the content or appearance of this document is unlawful and offenders may be prosecuted to the fullest extent of the law. Unless otherwise stated the results shown in this test report refer only to the sample(s) tested.

Attention: To check the authenticity of testing /inspection report & certificate, please contact us at telephone: (86-755) 8307 1443, or email: CN.Doccheck@sgs.com

Test Report

No. CANEC2218227003

Date: 30 Aug 2022

Page 3 of 8

<u>Test Item(s)</u>	<u>Limit</u>	<u>Unit</u>	<u>MDL</u>	<u>003</u>
Pentabromodiphenyl ether	-	mg/kg	5	ND
Hexabromodiphenyl ether	-	mg/kg	5	ND
Heptabromodiphenyl ether	-	mg/kg	5	ND
Octabromodiphenyl ether	-	mg/kg	5	ND
Nonabromodiphenyl ether	-	mg/kg	5	ND
Decabromodiphenyl ether	-	mg/kg	5	ND
Dibutyl phthalate (DBP)	1000	mg/kg	50	ND
Butyl benzyl phthalate (BBP)	1000	mg/kg	50	ND
Bis (2-ethylhexyl) phthalate (DEHP)	1000	mg/kg	50	ND
Diisobutyl Phthalates (DIBP)	1000	mg/kg	50	ND

Notes :

- (1) The maximum permissible limit is quoted from RoHS Directive (EU) 2015/863.
 - (2) IEC 62321 series is equivalent to EN 62321 series
 - (3) ▼= a. The sample is positive for CrVI if the CrVI concentration is greater than 0.13 µg/cm². The sample coating is considered to contain CrVI
 b. The sample is negative for CrVI if CrVI is ND (concentration less than 0.10 µg/cm²). The coating is considered a non-CrVI based coating
 c. The result between 0.10 µg/cm² and 0.13 µg/cm² is considered to be inconclusive - unavoidable coating variations may influence the determination
- Information on storage conditions and production date of the tested sample is unavailable and thus Cr(VI) results represent status of the sample at the time of testing.

Perfluorooctanoic acid (PFOA) and its salts & Perfluorooctane sulfonates (PFOS) and its derivatives

Test Method : With reference to CEN/TS15968:2010, analysis was performed by LC-MS or LC-MS/MS.

<u>Test Item(s)</u>	<u>CAS NO.</u>	<u>Unit</u>	<u>MDL</u>	<u>003</u>
Perfluorooctanoic acid (PFOA) and its salts+	335-67-1	mg/kg	0.010	ND
Perfluorooctane sulfonates (PFOS) ^	1763-23-1	mg/kg	0.010	ND
Perfluorooctane Sulfonamide (PFOSA)	754-91-6	mg/kg	0.010	ND
N-methylperfluoro-1-octanesulfonamide(MeFOSA)	31506-32-8	mg/kg	0.010	ND
N-ethylperfluoro-1-octanesulfonamide (EtFOSA)	4151-50-2	mg/kg	0.010	ND
2-(N-methylperfluoro-1-octanesulfonamido)-ethanol(MeFOSE)	24448-09-7	mg/kg	0.010	ND
2-(N-ethylperfluoro-1-octanesulfonamido)-ethanol(EtFOSE)	1691-99-2	mg/kg	0.010	ND
Perfluorooctane sulfonates (PFOS) and its derivatives	-	mg/kg	-	ND

Notes :



Unless otherwise agreed in writing, this document is issued by the Company subject to its General Conditions of Service printed overleaf, available on request or accessible at <http://www.sgs.com/en/Terms-and-Conditions.aspx> and, for electronic format documents, subject to Terms and Conditions for Electronic Documents at <http://www.sgs.com/en/Terms-and-Conditions/Terms-e-Documents.aspx>. Attention is drawn to the limitation of liability, indemnification and jurisdiction issues defined therein. Any holder of this document is advised that information contained hereon reflects the Company's findings at the time of its intervention only and within the limits of Client's instructions, if any. The Company's sole responsibility is to its Client and this document does not exonerate parties to a transaction from exercising all their rights and obligations under the transaction documents. This document cannot be reproduced except in full, without prior written approval of the Company. Any unauthorized alteration, forgery or falsification of the content or appearance of this document is unlawful and offenders may be prosecuted to the fullest extent of the law. Unless otherwise stated the results shown in this test report refer only to the sample(s) tested.

- (1) + PFOA and its salts including PFOA-Na (CAS No.: 335-95-5), PFOA-K (CAS No.: 2395-00-8), PFOA-Ag (CAS No.: 335-93-3), PFOA-F (CAS No.: 335-66-0) and APFO (CAS No.: 3825-26-1);
- (2) ^ PFOS including PFOS-K (CAS No.: 2795-39-3), PFOS-Li (CAS No.: 29457-72-5), PFOS-NH₄ (CAS No.: 29081-56-9), PFOS-NH(OH)₂ (CAS No.: 70225-14-8), PFOS-N(C₂H₅)₄ (CAS No.: 56773-42-3), PFOS-DDA(CAS No.:251099-16-8) and POSF (CAS No.: 307-35-7)

Unless otherwise stated, the decision rule for conformity reporting is based on Binary Statement for Simple Acceptance Rule ($w=0$) stated in ILAC-G8:09/2019.



Unless otherwise agreed in writing, this document is issued by the Company subject to its General Conditions of Service printed overleaf, available on request or accessible at <http://www.sgs.com/en/Terms-and-Conditions.aspx> and, for electronic format documents, subject to Terms and Conditions for Electronic Documents at <http://www.sgs.com/en/Terms-and-Conditions/Terms-e-Documents.aspx>. Attention is drawn to the limitation of liability, indemnification and jurisdiction issues defined therein. Any holder of this document is advised that information contained hereon reflects the Company's findings at the time of its intervention only and within the limits of Client's instructions, if any. The Company's sole responsibility is to its Client and this document does not exonerate parties to a transaction from exercising all their rights and obligations under the transaction documents. This document cannot be reproduced except in full, without prior written approval of the Company. Any unauthorized alteration, forgery or falsification of the content or appearance of this document is unlawful and offenders may be prosecuted to the fullest extent of the law. Unless otherwise stated the results shown in this test report refer only to the sample(s) tested.

Attention: To check the authenticity of testing /inspection report & certificate, please contact us at telephone: (86-755) 8307 1443, or email: CN.Doccheck@sgs.com

ATTACHMENTS

Pb/Cd/Hg/Cr⁶⁺/PBBs/PBDEs Testing Flow Chart

1) These samples were dissolved totally by pre-conditioning method according to below flow chart. (Cr⁶⁺ and PBBs/PBDEs test method excluded).

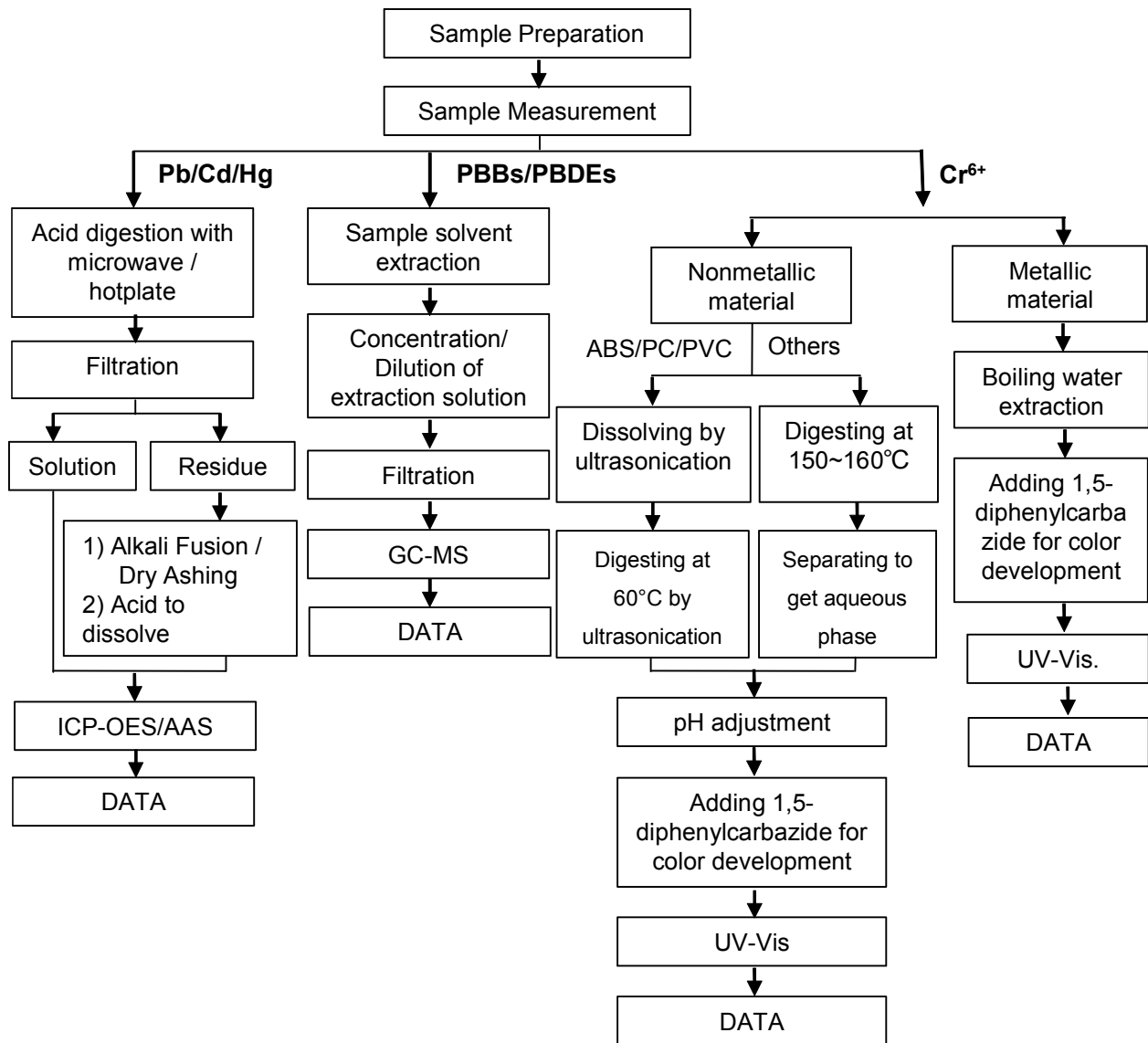

ATTACHMENTS

Phthalates Testing Flow Chart

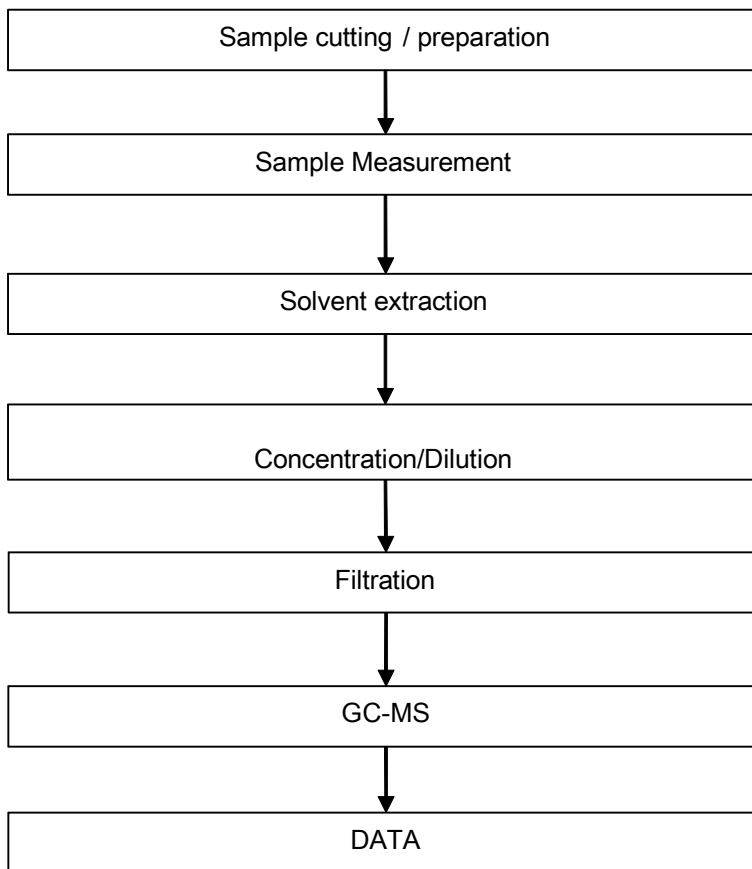

Unless otherwise agreed in writing, this document is issued by the Company subject to its General Conditions of Service printed overleaf, available on request or accessible at <http://www.sgs.com/en/Terms-and-Conditions.aspx> and, for electronic format documents, subject to Terms and Conditions for Electronic Documents at <http://www.sgs.com/en/Terms-and-Conditions/Terms-e-Document.aspx>. Attention is drawn to the limitation of liability, indemnification and jurisdiction issues defined therein. Any holder of this document is advised that information contained hereon reflects the Company's findings at the time of its intervention only and within the limits of Client's instructions, if any. The Company's sole responsibility is to its Client and this document does not exonerate parties to a transaction from exercising all their rights and obligations under the transaction documents. This document cannot be reproduced except in full, without prior written approval of the Company. Any unauthorized alteration, forgery or falsification of the content or appearance of this document is unlawful and offenders may be prosecuted to the fullest extent of the law. Unless otherwise stated the results shown in this test report refer only to the sample(s) tested.

Attention: To check the authenticity of testing / inspection report & certificate, please contact us at telephone: (86-755) 8307 1443, or email: CN_Doccheck@sgs.com

ATTACHMENTS

PFOA / PFOS Testing Flow Chart

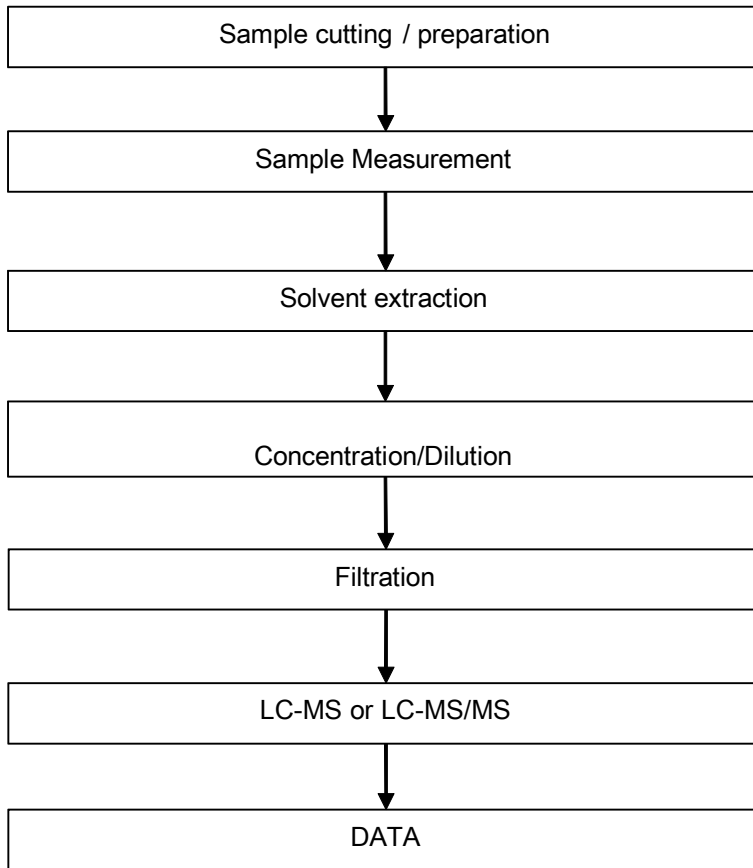

Unless otherwise agreed in writing, this document is issued by the Company subject to its General Conditions of Service printed overleaf, available on request or accessible at <http://www.sgs.com/en/Terms-and-Conditions.aspx> and, for electronic format documents, subject to Terms and Conditions for Electronic Documents at <http://www.sgs.com/en/Terms-and-Conditions/Terms-e-Document.aspx>. Attention is drawn to the limitation of liability, indemnification and jurisdiction issues defined therein. Any holder of this document is advised that information contained hereon reflects the Company's findings at the time of its intervention only and within the limits of Client's instructions, if any. The Company's sole responsibility is to its Client and this document does not exonerate parties to a transaction from exercising all their rights and obligations under the transaction documents. This document cannot be reproduced except in full, without prior written approval of the Company. Any unauthorized alteration, forgery or falsification of the content or appearance of this document is unlawful and offenders may be prosecuted to the fullest extent of the law. Unless otherwise stated the results shown in this test report refer only to the sample(s) tested.

Attention: To check the authenticity of testing / inspection report & certificate, please contact us at telephone: (86-755) 8307 1443, or email: CN.Doccheck@sgs.com

Sample photo:



SGS authenticate the photo on original report only

*** End of Report ***

