

REV.	ECN.NO.	APPD.
A	/	/

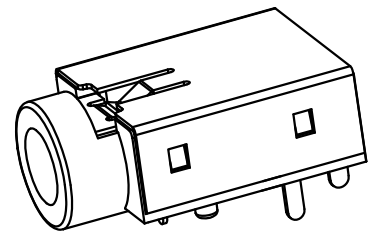

- 1.CURRENT RATING : 1.0 AMP. MAX.
- 2.DIELECTRIC WITHSTANDING : AC 500V/min R.M.S.
- 3.INSULATION RESISTANCE : 100MΩ min. AT 100V DC.
- 4.CONTACT RESISTANCE : 50mΩ MAX.
- 5.OPERATING TEMPERATURE : -25°C TO +85°C.
- 6.DURABILITY : 1500 CYCLES.
- 7.MATING FORCE : 3kgs MAX
- 8.UNMATING FORCE : 0.3~3.0kgs
- 9.MAX PROCESSING TEMPERATURE : 60 SECONDS IN 230°C AND 10 SECONDS IN 260°C

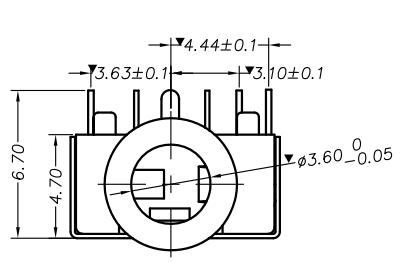
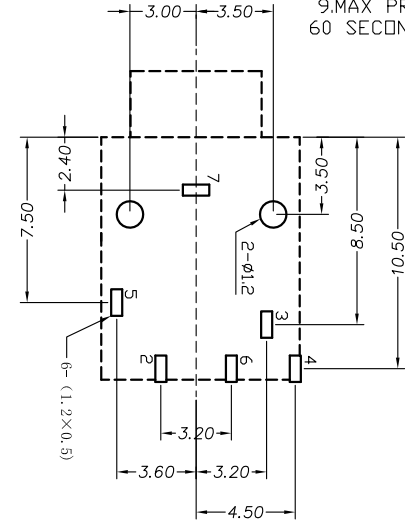
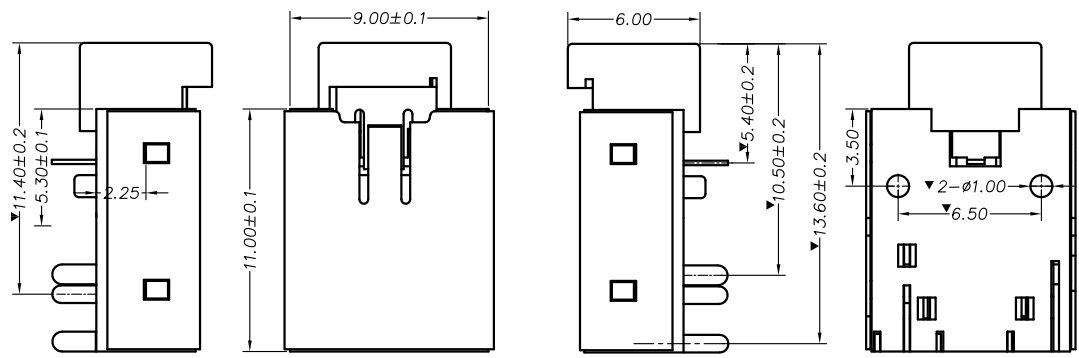

P. C. B LAYOUT TOP VIEW

JK1-179-G518  
 G: 镀银  
 5: PA9T 绿色

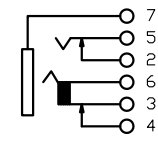
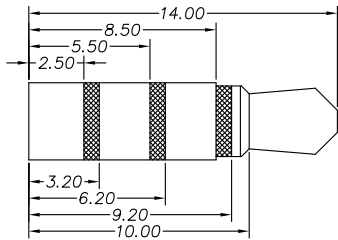
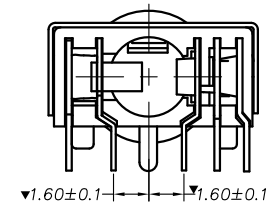

8	PJ-353-08	外壳	1	磷铜	0.20T	镀镍	主要技术性能	
7	PJ-353-07	小盖脚	1	磷铜	0.20T	镀银		
6	PJ-353-06	小脚	1	磷铜	0.20T	镀银		额定电负荷 DC 30V/0.5A
5	PJ-353-05	弹片脚	1	磷铜	0.25T	镀银		接触电阻 ≤0.03 Ω
4	PJ-353-04	大脚弹片	1	磷铜	0.25T	镀银		绝缘电阻 ≥100MΩ
3	PJ-353-03	大插片脚	1	磷铜	0.25T	镀银		耐压 AC500V(50Hz)/min
2	PJ-353-02	小插片脚	1	黄铜	0.20T	镀银		插拔力 3-20N
1	PJ-353-01	基座	1	PBT		黑色		使用温度范围 -30~70℃
								使用寿命 5000次

TOLERANCE UNLESS OTHERWISE SPECIFIED	
.XXX ±0.10	.X' ±3'
.XX ±0.20	.XX' ±2'
.X ±0.30	

**FLW** 深圳市华联威电子科技有限公司  
 HUA LIAN WEI TECHNOLOGY ELECTRONICS CO;LTD.

APPROVED		PART NAME:	PJ-353-5P带壳3.5耳机插座			
CHECKED		PART No:	JK1-179-G518		C	
DRAWN	weihong	PROJECTION:	UNIT:	SCALE	SHEET	REV.
DATE	2021.9.23		mm	1:1	10F1	A