

REV.	ECN. NO.	APPD.
A	/	ZFY

NOTES:

1. MATERIAL:

- 1.1 Housing:thermoplastic plastics
- 1.2 terminals:Copper Alloy
Gold plated in contact area:
Tin plated in termination
Nickel Plated overall
- 1.3 Shell:Steel&Copper Alloy
Nickel/Au Plated overall

2. characteristics:

- 2.1 Rating Voltage : 30V AC.
 - 2.2 Rating Current:
5A for Vbus PIN;1.25A for Vconn PIN
 - 2.3 Contact Resistance:40 mΩ MAX.
 - 2.4 Insulation Resistance:100 MΩ MIN.
 - 2.5 Withstanding Voltage:AC 100V
 - 2.6 Mating force: 5~20N MAX
 - 2.7 Extraction force:8~20N Min
 - 2.8 Life test:10000Cycles MIN.
 - 2.9 Temperature Range: -30℃~+80℃.
- The product must be compliance ROHS

U572-272B-G61118

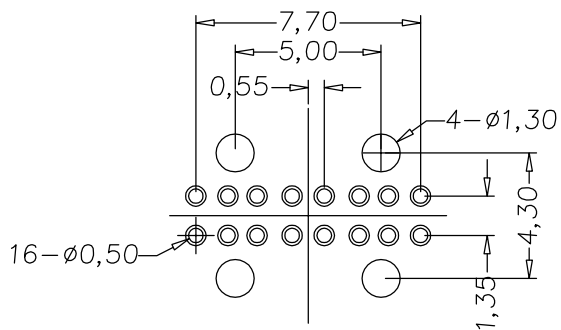
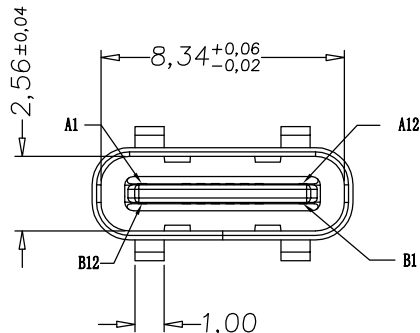
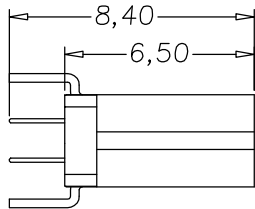
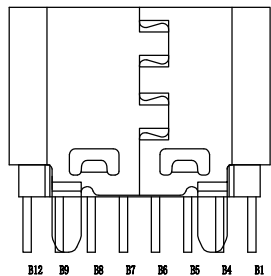
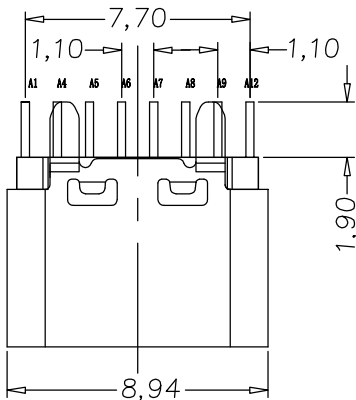
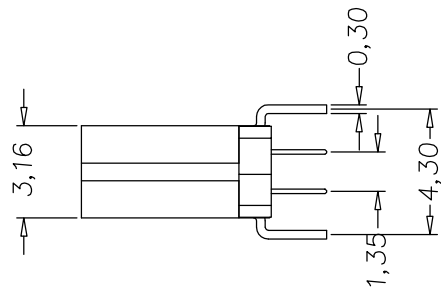
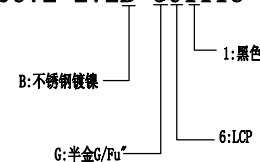

RECOMMENDED P.C.B. LAYOUT
TOLERANCE UNSPECIFIED ±0.05mm

A1	GND	B12	GND
A4	VBUS	B9	VBUS
A5	CC1	B8	SBU2
A6	DP1	B7	DN2
A7	DN1	B6	DP2
A8	SBU1	B5	CC2
A9	VBUS	B4	VBUS
A12	GND	B1	GND
PIN	SIGNAL NAME	PIN	SIGNAL NAME

TOLERANCE UNLESS OTHERWISE SPECIFIED	
.XXX ±0.15	.'X' ±5'
.XX ±0.20	.'XX' ±2'
.X ±0.30	
APPROVED	
CHECKED	
DRAWN	ZhangFenYan
DATE	2018. 10. 10

FLW 深圳市华联威电子科技有限公司						
HUA LIAN WEI TECHNOLOGY ELECTRONICS CO.;LTD.						
PART NAME:		TYPE C 16P 立插 H6.5				
PART No:		U572-272B-G61118			C	
DRAWN	ZhangFenYan	PROJECTION:	UNIT:	SCALE	SHEET	REV.
DATE	2018. 10. 10		mm	1:1	10F1	A