

承 认 书

Approval Sheet

客户 (Customer): /

客户料号 (Cus .P/N): /

华联威料号 (HLW P/N): 216104-1105-G63038

品名规格 (PronameSpec): 针座1.25 卧贴SMT3P载带

送样日期 (Delivery Date): 2022/07/28

承认日期 (Acknowledge Date): 2022/07/28

Approved No:		客 户 Customer	
采 购 部 Purchasing Dept	品 质 部 QC Dept	工 程 部 Engineering Dept	确 认 Approved By
深 圳 市 华 联 威 电 子 科 技 有 限 公 司 SHEN ZHEN SHI HUA LIAN WEI ELECTRONICS TECHNOLOGY CO; LTD.			
业 务 部 Sales Dept	品 管 部 QC Dept	工 程 部 Engineering Dept	核 准 Checked By
吴鑫萍	欠必锋	陈建辉	唐竹君

地址: 深圳市龙华区观澜街道桂香社区观澜桂花路 307 号

TEL: 0755-28888886 28888866

邮箱: hua@hlwconn.com

[Http://www.hlwconn.com](http://www.hlwconn.com)

目 录

Contents

图纸.....	Page03
产品规格书.....	Page04-07
产品检测报告.....	Page08-09
尺寸测试报告.....	Page10
电镀报告.....	Page11
盐雾报告.....	Page12
材质证明.....	Page13-14
SGS.....	Page15-40

REV.	ECN.NO.	APPD.
A	/	/

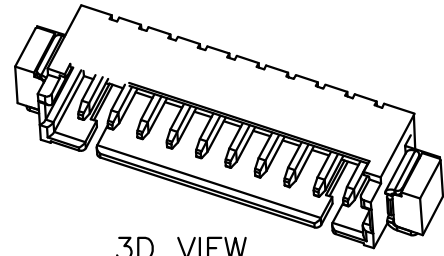

3D VIEW

技术指标 (Technical Index) :

1. 工作温度 (Temperature range) : -25° C-85° C.
2. 额定电压 (Rated voltage) : 250V DC/AC (rms)
3. 额定电流 (Rated current) : 5A AC, DC
4. 接触阻抗 (CONTACT Resistance) : $\leq 25M\Omega$
5. 耐压值 (Withstanding voltage) : 1500V AC/minute
6. 绝缘阻抗 (Insulation resistance) $\geq 1000M\Omega$

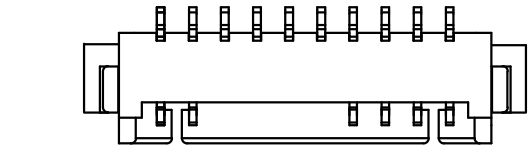

A 17.20

B 14.15

C 13.15

2.50

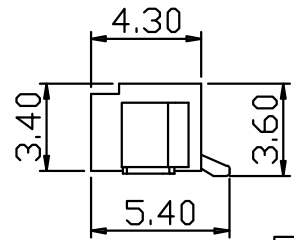

4.30

3.40

3.60

0.10

5.40

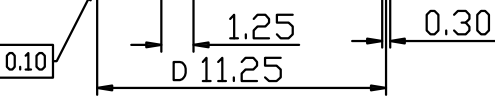

1.25

D 11.25

0.30

216104-1105-G63038

G:半金G/Fu”
3:米黄色
6:LCP

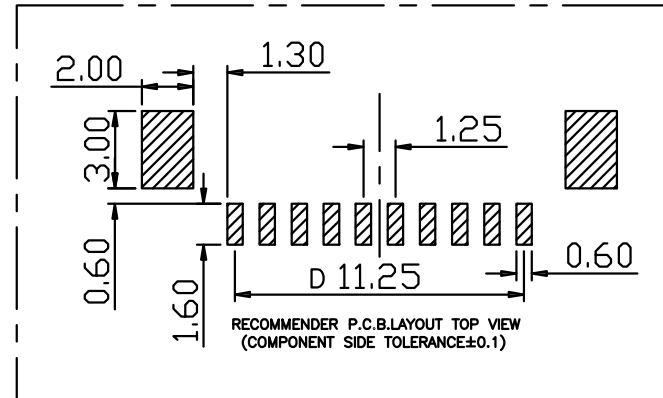
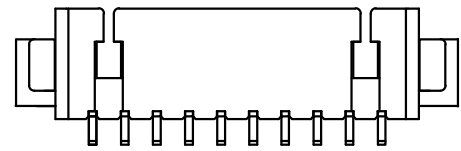

TOLERANCE UNLESS OTHERWISE SPECIFIED	
.XXX ± 0.10	.X' $\pm 3'$
.XX ± 0.20	.XX' $\pm 2'$
.X ± 0.30	

FLW 深圳市华联威电子科技有限公司
HUA LIAN WEI TECHNOLOGY ELECTRONICS CO.;LTD.

APPROVED		PART NAME:	针座 1.25卧贴 SMT 2P 载带			
CHECKED		PART No:	216104-1105-G63038		C	
DRAWN	weihong	PROJECTION:	UNIT:	SCALE	SHEET	REV.
DATE	2021.9.23		mm	1:1	10F1	A

深圳市华联威电子科技有限公司

针座系列产品SPEC

1. 适用范围 Scope of application

本规范适用于GH系列产品。 This specification is applicable to GH series products

2. 标准额定值 Standard rating

项目 project	规格 specifications
额定电压 The rated voltage	50V AC/DC
额定电流 Rated current	1.0A AC/DC
使用温度范围 Operating temperature range	-40℃~+105℃
使用湿度范围 Operating humidity range	相对湿度90%以下 Relative humidity is below 90%

3. 环保 The environmental protection

产品符合ROHS环保要求。 Products in line with ROHS environmental protection requirements.

4. 包装 Packing

产品内包装详见包装要求，外包装为纸箱，产品在箱内密封，不晃动。

The inner packing of the product is joint and several, the outer packing is carton, the product is sealed in the box, do not shake.

5. 运输 transport

允许用任何方式运输，但需避免雨雪淋和阳光照射，不能有碰撞和挤压等机械损伤，运输环境温度为-20℃+50℃
It is allowed to be transported by any means, but it should avoid rain, snow and sunlight, no mechanical damage such as collision and extrusion, and the ambient temperature of transportation is -20℃+50℃

6. 贮存: Storage

包装完毕连接器应在环境温度为-20℃~+50℃，相对湿度不大于90%，周围空气中没有酸性，碱性及其它腐蚀性气体的仓库中贮存。

After packaging, the connector should be in the ambient temperature of -20℃~+50℃，the relative humidity should not be more than 90%, there is no acid, alkaline and other decay in the surrounding air Storage of corrosive gases in a warehouse.

7. 部件名称/部件规格型号/部件材质 Part name/part specification/part material

部件名称 Part name	型号 model	材质 The material
基座 base	GH	LCP
插针 pin	GH	黄铜/磷铜 Phosphor copper C5191/C2680
固定片 stator	GH	黄铜/磷铜 Phosphor copper C5191/C2680
盖板	GH	LCP

8. 外观及尺寸 Appearance and size

8.1 外观 appearance

塑胶件表面应无明显疤痕、杂色、开裂、毛刺、飞边、缺料及影响使用的变形；金属件表面应光洁、无锈蚀、氧化、脱皮、发黑及明显的机械损伤等缺陷。

The surface of plastic parts shall be free of obvious scars, mottled, cracked, burr, flash, lack of material and deformation affecting the use; the surface of metal parts shall be smooth and clean No rust, oxidation, peeling, blackening and obvious mechanical damage.

8.2 尺寸 size

参照工程图 Reference engineering drawing

深圳市华联威电子科技有限公司

针座系列产品SPEC

9. 电气特性 Electrical characteristics

编号 number	项目 project	试验方法 Test method for	性能要求 performance requirements
9.1	接触电阻 contact resistance	将连接器插合，用接触电阻仪进行测试，测量连接器两个端子之间组成一个闭合的回路。 Plug in the connector and test it with a contact resistance meter to measure both terminals of the connector Form a closed loop between.	20mΩ Max
9.2	绝缘电阻 Insulation resistance	将连接器插合，在相邻接触件之间和接触件与外壳之间施加100V DC电压，持续1分钟进行测试。 Plug in the connector and apply 100V DC voltage between the adjacent contacts and between the contacts and the enclosure for 1 minute.	500MΩ Min
9.3	耐电压 Withstand voltage	将连接器插合，在相邻接触件之间和接触件与外壳之间施加500V AC电压，持续1分钟进行测试。 Plug in the connector and apply 500V AC voltage between the adjacent contacts and between the contacts and the enclosure for 1 minute.	无击穿和飞弧现象 No breakdown and flashover

10. 环境特性

编号 number	项目 project	试验方法 Test method for	性能要求 performance requirements
10.1	耐热试验 Heating test	将插合连接器放在温度为+105℃±2℃的环境中96H,取出放在正常环境中1~2H后再进行测试。 Put the plug connector in the environment of +105℃±2℃ for 96H, take it out and put it in the normal environment for 1~2H before testing.	外观：外观无损伤 Appearance: appearance without
			接触电阻：60mΩ Max Contact resistance: 60mΩ Max
10.2	耐冷试验 Cold tolerance test	将插合连接器放在温度为-40℃±2℃的环境中96H,取出放在正常环境中1~2H后再进行测试。 The plug connector was placed in the environment with the temperature of -40℃±2℃ for 96H, and was taken out and placed in the normal environment for 1~2H before being tested.	外观：外观无损伤 Appearance: appearance without damage
			接触电阻：60mΩ Max Contact resistance: 60mΩ Max
10.3	耐湿性试验 Moisture resistance test	将插合连接器放在温度为40℃±2℃，相对湿度90~96%的环境中，持续96H,经试验后，取出放在正常环境中1~2H后再进行测试。 Place the plug connector in an environment with a temperature of 40℃±2℃ and relative humidity of 90~96%. Last for 96H, after the test, take it out and put it in the normal environment for 1~2H before the test.	外观：外观无损伤 Appearance: appearance without
			绝缘电阻：60MΩ MIN Insulation resistance: 60MΩ min
			耐电压符合9.3要求 Withstand voltage meets 9.3 requirements

深圳市华联威电子科技有限公司

针座系列产品SPEC

编号 number	项目 project	试验方法 Test method for	性能要求 performance requirement
10.4	温度循环 Temperature cycle	<p>把试验样品分别放入高低温试验箱，按下列步骤调试温度：</p> <p>a. 在$-40^{\circ}\text{C} \pm 2^{\circ}\text{C}$的恒温条件下放置30分钟</p> <p>b. 在常温条件下放置1H</p> <p>C. 在$+105^{\circ}\text{C} \pm 2^{\circ}\text{C}$的恒温条件下放置30分钟</p> <p>D. 在常温条件下放置1H</p> <p>从a到d为一个循环周期，共进行5个循环，在正常环境中恢复2H后进行检查。</p> <p>Put the test samples into the high and low temperature test chamber, and adjust the temperature according to the following steps:</p> <p>A. Place for 30 minutes under the constant temperature of $-40^{\circ}\text{C} \pm 2^{\circ}\text{C}$</p> <p>B. Place at room temperature for 1 hour</p> <p>C. Place for 30 minutes at a constant temperature of $+105^{\circ}\text{C} \pm 2^{\circ}\text{C}$</p> <p>D. Place at room temperature for 1 hour</p> <p>From a to d is a cycle period, a total of 5 cycles are carried out, and 2H is recovered in the normal environment. Check later.</p>	<p>外观：无任何异状</p> <hr/> <p>接触电阻：60mΩ Max Contact resistance: 60mΩ Max</p>
10.5	盐雾试验 Salt Spray Test	<p>将试验样品从试验箱顶悬挂下来，采用浓度为(5 ± 1) %的氯化钠溶液，连续喷雾24H，试验后用流动的蒸溜水轻轻洗去表面沉淀积物，在常温条件下恢复1~2H后再检查测量。</p> <p>The test sample was suspended from the top of the test box, and the concentration of (5 ± 1) % Sodium Chloride Solution was continuously sprayed with 24H. After testing, the surface precipitates were lightly washed with flowing steaming water, then the 1~2H was rechecked at normal temperature.</p>	<p>外观：无损伤、腐蚀 (五金件应无露出底金属的严重锈蚀；使用预镀好的型材，其落料面允许有不影响其性能的轻微腐蚀。</p> <p>Appearance: no damage or corrosion (hardware should not expose the bottom metal of serious corrosion: use pre-plating. The blanking surface is allowed to have a slight corrosion that does not affect its performance.</p> <hr/> <p>接触电阻：60mΩ Max Contact resistance: 60mΩ Max</p>

深圳市华联威电子科技有限公司 针座系列产品SPEC

编号 number	项目 project	试验方法 Test method for	性能要求 performance requirement
10.6	可焊性 weldability	把试验样品需要焊接的部位浸入 $240 \pm 5^{\circ}\text{C}$ 的锡溶液中，保持 2.5 ± 0.5 秒。 Dip the welded part of the test sample into $240 \pm 5^{\circ}\text{C}$ tin solution and hold 2.5 ± 0.5 seconds.	沾锡面积95%以上 Tin area above 95%
10.7	耐焊性 Soldering resistance	将连接器置于PCB板上，然后将产品通过 $260^{\circ}\text{C} \pm 5^{\circ}\text{C}$ 回流焊或波峰焊 $5 \pm 1\text{S}$ 进行测试。 Place the connector on the PCB, and then reflow the product through $260^{\circ}\text{C} \pm 5^{\circ}\text{C}$ Or wave soldering for $5 \pm 1\text{s}$.	1. 塑胶件不得有明显变形损坏起泡。 2. 电气特性必须符合规格。 Plastic parts shall be free from obvious deformation, damage and blistering. 2. The electrical characteristics must meet the specifications.

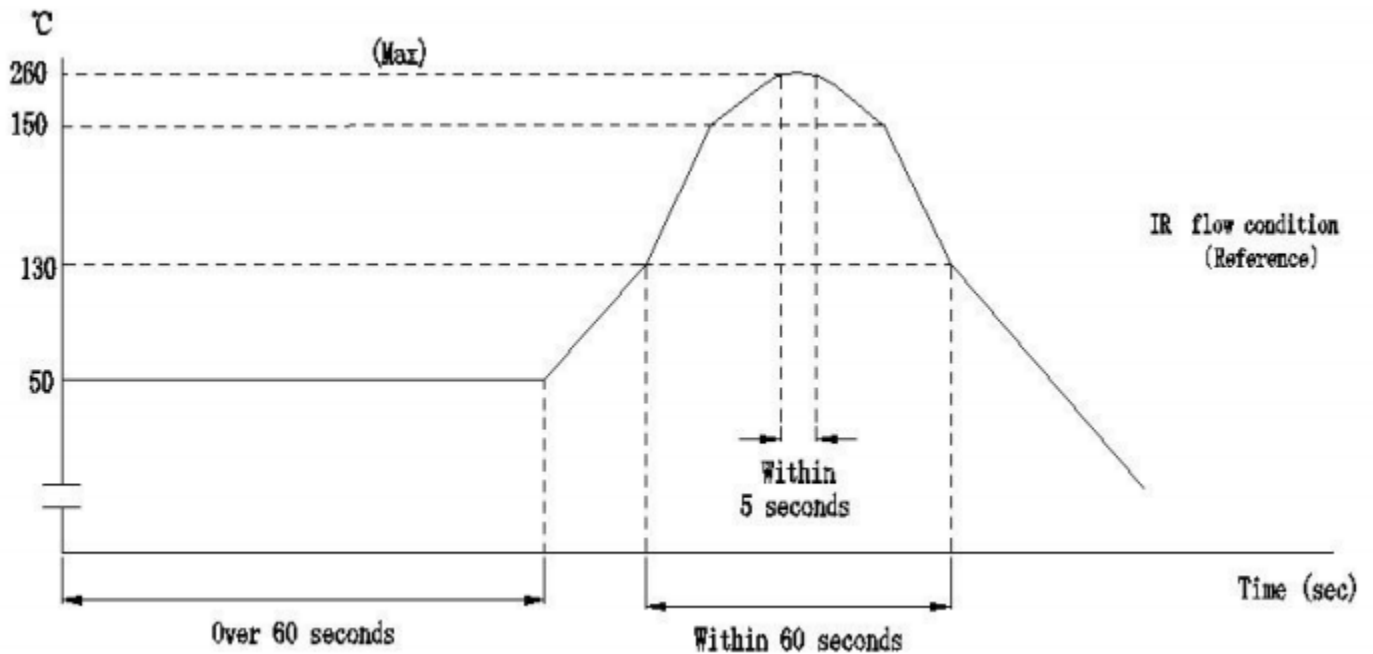

深圳市华联威电子科技有限公司

针座系列产品SPEC

11. 机械特性 mechanical properties

编号 number	项目 project	试验方法 Test method for	性能要求 performance requirement				
11.1	PIN针固定力 Pin fixing force	将针座固定在插拔力机上，在针脚前端施加力，以每分钟 25 ± 3 mm的速率，直到针退出针座的拔出力。 Fix the pin holder on the drawing machine and apply force on the front end of the pin at a rate of 25 ± 3 mm per minute until the pin is withdrawn from the pin holder.	单一PIN针5N Min Single pin 5N min				
11.2	端子在塑胶件中保持力 Terminal retention in plastic parts	端子与孔座配合，以每分钟 25 ± 3 mm的速率沿导线方向，将端子从孔座中拔出的力。 The terminal shall be matched with the hole seat, and at the rate of 25 ± 3 mm per minute along the conductor direction, theThe force that the terminal is pulled out of the socket.	单一端子： 7N Min Single terminal: 7N min				
11.3	机械寿命 Mechanical life	无通电状态下，10次/分钟的速度插拔30次。 Under no power on state, plug and unplug 30 times at the speed of 10 times / min.	接触电阻： 80mΩ Max Contact resistance: 80mΩ Max				
11.5	插入力拔出力 Insertion pull out force	试验方法：Test methods (1) 将孔座和端子配合好，与针座在同一轴线上进行插拔测试，测试时需将孔座锁扣去掉。（测试速度： 20 ± 5 mm) minute (1) Fit the hole seat and the terminal, and conduct the insertion and removal test on the same axis with the needle seat. Remove the lock of the hole seat (test speed: 20 ± 5 mm) minute during the test (2) 性能要求：Performance requirements					
		孔位	插入(N) insert (max)	拔出(N) Pull out (min)	孔位	插入(N) insert (max)	拔出(N) Pull out (min)
		2PIN	19.5	4.0	10PIN	35.5	8.0
		3PIN	21.5	4.5	11PIN	36.5	8.5
		4PIN	23.5	5.0	12PIN	37.5	9.0
		5PIN	25.5	5.5	13PIN	38.5	9.5
		6PIN	27.5	6.0	14PIN	39.5	10.0
		7PIN	29.5	6.5	15PIN	40.5	10.5
		8PIN	31.5	7.0	16PIN	41.5	11.0
		9PIN	33.5	7.5			

7	耐久性	测试速度：每分钟15个循环，测试次数：100次循环最少	插拔力計	不得发生物理损坏。	OK	OK	OK	OK	OK	V	
---	-----	-----------------------------	------	-----------	----	----	----	----	----	---	--

三. 环境特性测试 ENVIRONMENTAL TEST

序號 NO	測試項目 Testing Item	測試條件 Testing Conditions	測試設備 Testing Equipment	規格 SPEC	測試記錄Testing Result					判定 Judge	
					1	2	3	4	5	OK	NG
9	冷热冲击	温度-40±3℃ 温度105±3℃ 持续时间0.5H	高低温试验箱	不得发生物理损坏。	OK	OK	OK	OK	OK	V	
10	湿温循环	温度85℃±5℃， 持续时间:250H	湿温循环机	最大接触阻抗20mΩ	OK	OK	OK	OK	OK	V	
11	盐雾试验	温度:35±2℃ 12小时	盐雾试验箱	最大接触阻抗20mΩ	OK	OK	OK	OK	OK	V	
12	可焊性	焊锡温度: 260±5℃	熔锡炉	沾锡面积达90%以上	OK	OK	OK	OK	OK	V	
13	焊接耐热试验	260±5℃ 10秒	工业烘烤箱	不得发生物理损坏	OK	OK	OK	OK	OK	V	

綜合判定 TEST JUDGMENT	<input checked="" type="checkbox"/> 合格 (Acceptable) <input type="checkbox"/> 不合格 (Reject)										
-----------------------	---	--	--	--	--	--	--	--	--	--	--

核准(Approver): 欠必鋒 測試(Tester): 但芬

檢驗報告

首件檢驗
 入庫檢驗
 出貨檢驗
 客退檢驗
 退料檢驗
 其他

2022年07月28日 版次:A1

料號	216104-1105-G63038	制令單號	/	送檢單位	工程部	首件製作者	裝配	
品名	針座1.25 卧貼SMT3P載帶	客戶代號	/	批 量	/	送檢時間	/	
				數 量	5PCS	確認時間	/	
抽樣標準		<input checked="" type="checkbox"/> 單次 <input type="checkbox"/> 雙次		抽樣數 (5PCS)	AQL	CRI:0 MAJ:0.40	MIN:0.65	
MIL-STD-105E(II)		<input checked="" type="checkbox"/> 正常 <input type="checkbox"/> 加嚴 <input type="checkbox"/> 減量			ACC/REJ	0	/	/
不良數: CRI (/) MAJ (/) MIN (/)						不良率(%)		/

NO.	檢驗項目 單位:MM/G	檢測 儀器	檢 驗 記 錄					品管判定		CRI	MAJ	MIN	備注
			1	2	3	4	5	AC	RE				
	17.20±0.20	D	17.22	17.20	17.23	17.20	17.21	√					
	14.15±0.20	D	14.16	14.15	14.13	14.15	14.15	√					
	13.15±0.20	D	13.16	13.15	13.16	13.15	13.14	√					
	2.50±0.20	D	2.52	2.52	2.53	2.52	2.52	√					
	3.40±0.20	D	3.43	3.40	3.42	3.43	3.41	√					
	4.30±0.20	D	4.31	4.30	4.32	4.32	4.34	√					
	3.60±0.20	D	3.62	3.61	3.60	3.60	3.62	√					
	5.40±0.20	D	5.42	5.43	5.46	5.42	5.43	√					
	11.25±0.20	D	11.24	11.25	11.23	11.24	11.26	√					
	1.25±0.20	D	1.26	1.24	1.23	1.25	1.25	√					
	0.30±0.20	D	0.31	0.32	0.33	0.32	0.31	√					

 檢驗依據: 《工程圖紙》 《檢驗規範》 《承認書》 樣品 其它

檢測儀器:A游標卡尺 B千分尺 C厚薄儀 D投影鏡 E放大鏡 F顯微鏡 G錫爐 H插拔力器 I間位尺 J其它

品保判定:

核 准 APP	欠必鋒	審 核 CHK	/	檢驗員 INSPBY	但芬
------------	-----	------------	---	---------------	----

保存期限:三年

保存部門:品保部

QR-M-003

品名:针座1.25 卧贴SMT3P载带(端子)				版次:A.0	
电镀规格:Ni30u", Sn100u", Au G/Fu"			日期:2022-07-04		页次:1/1
厂商:同华					
测试设备:CMI X-射线膜厚测试仪					
1、底层电镀测试(Ni)					
数据	测试标准	实测值	判定	测试日期	测试时间
1	30u"MIN	50.5u"	OK	2022/7/4	10:20:15
2	30u"MIN	56.3u"	OK	2022/7/4	10:20:17
3	30u"MIN	67.5u"	OK	2022/7/4	10:20:19
4	30u"MIN	62.4u"	OK	2022/7/4	10:20:21
2、表层电镀测试(Sn)					
数据	测试标准	实测值	判定	测试日期	测试时间
1	100u"MIN	105.3u"	OK	2022/7/4	10:25:10
2	100u"MIN	104.7u"	OK	2022/7/4	10:25:12
3	100u"MIN	105.9u"	OK	2022/7/4	10:25:14
4	100u"MIN	107.4u"	OK	2022/7/4	10:25:16
3、表层电镀测试(Au)					
数据	测试标准	实测值	判定	测试日期	测试时间
1	0.5u"MIN	0.52u"	OK	2022/7/4	10:30:32
2	0.5u"MIN	0.55u"	OK	2022/7/4	10:30:34
3	0.5u"MIN	0.53u"	OK	2022/7/4	10:30:36
4	0.5u"MIN	0.54u"	OK	2022/7/4	10:30:38

核准: 欠必锋

审核: 李娟

检验员: 但芬



深圳市华联威电子科技有限公司

盐水喷雾实验报告

试验方法	盐水喷雾腐蚀试验法	参考资料	MIL-STD-1345
METHOD	NEUTRL SALT SPRAY CORROSION TEST	REF	
客户		试验起始日期	2022年07月27日 20:00 时起
		DATE	2022年07月28日 08:00 时止
样品名称	针座1.25 卧贴SMT3P载带	试验数量	5PCS
P/N	216104-1105-G63038	QTY	

试验条件 (TEST CONDITION)

- 1、盐水溶解 (SALT SOLUTION: 浓度 $50 \pm 10\text{g/L}$, PH值6.5-7.2).
- 2、试验室温度 (TEMP. IT THE SPRAY DHAMBR): $35 \pm 1^\circ\text{C}$.
- 3、盐水桶温度 (TEMP. OF SALE SOL' N TANK): $35 \pm 1^\circ\text{C}$.
- 4、压力桶温度 (TEMP. OF SAR SUPPLIERY): $47 \pm 1^\circ\text{C}$.
- 5、试验室相对湿度 (R. H IN THE CHAMBER) 85%.
- 6、压缩空气压力 (COMPRESSED AIR PRESSURE): $1.00 \pm 0.01\text{Kg/cm}^2$.
- 7、样品放置位置 (SPECIMEN SUPPORTED ANGLE): 尼龙绳吊挂 $70^\circ - 90^\circ$.
- 8、喷雾收集量 (COLLECT RATE OF SALT SOL' N) $1-2\text{mL}/(8 \text{ cm}^2\text{hr})$.
- 9、盐雾测试时间: 12小时 (H)

判定方法 (ADFUSGD METHOD)

试验后以20倍放大镜观察、无蓝、绿色腐蚀物之现象 (不包含折弯处), 即判定合格. (Inspext the ecimen at 20 xmagnification no blue or green corrosion products are acceptable)

样品序号	试验后现象	判定
	PHENOMENON AFTER TEST	COMMENT
1	无蓝、绿色腐蚀物之现象	OK
2	无蓝、绿色腐蚀物之现象	OK
3	无蓝、绿色腐蚀物之现象	OK
4	无蓝、绿色腐蚀物之现象	OK
5	无蓝、绿色腐蚀物之现象	OK

核准: 欠必锋

审核: 李娟

试验员: 但芬

鉅鼎銅材廠檢驗報告單

公司名稱 Customer	鉅鼎銅材廠檢驗報告單				重量 Weight(kg)	1078	出貨日期 Date	2021/11/23		
品名 Article	標準 Standard No				尺寸 Dimension		狀態 Tenper	銅卷編號 Coil No		
C2680	JISH3100:2017				0.18*400		EH	1021-C-08		
化學成分Chemical Compositions(%)										
元素 Element	Cu %	Zn%	Pb%	Fe%	\	\	\	\	化學成分	雜質
規範 Spec	64.0-68.0	餘量	<0.05	<0.05	\	\	\	\	合格	合格
實測 Actual	64.32	餘量	0.0036	0.0136	\	\	\	\	合格	合格
機械性質子Mechanical Properties										
項目 Item	結晶粒度 Grain Size Mm	硬度 Hardness Hv	抗拉強度 TensionStrength Mpa	伸長度 Elongation %	導電率 Electrical Conduc %IACS	彎曲試驗 Bending Test 180	表面粗度 Surface Roughness Ra(u m)	彎曲度 Camber mm/n		
規範MAX Spec	\	170-190	490-610	\	\	\	\	\		
實測 Actual	\	178	574	5	\	\	\	\		

品質部



东莞市海嵘兴塑胶有限公司

LCP材质分析报告

品 名	比 例	用 途
杜邦LCP树脂	0.68	构成材料主要成份
抗氧剂	0.003	抗氧化
日本住友TAP	0.002	润滑及增加流动性
大洋安定剂	0.005	稳定机械性能, 方便重复使用
玻纤	0.30	增强
色母	0.01	着色

注：以上数据真实可靠，但并非绝对值，并不做任何商业依据。

