

REV.	ECN.NO.	APPD.
A	XXXXXXXXXX	yangguifeng

No. of Contacts	DIM.				
	A	B	C	D	E
4	3.83	1.5	2.6	3.33	3.27
5	4.33	2.0	3.1	3.83	3.77
6	4.83	2.5	3.6	4.33	4.27
7	5.33	3.0	4.1	4.83	4.77
8	5.83	3.5	4.6	5.33	5.27
9	6.33	4.0	5.1	5.83	5.77
10	6.83	4.5	5.6	6.33	6.27
11	7.33	5.0	6.1	6.83	6.77
12	7.83	5.5	6.6	7.33	7.27
13	8.33	6.0	7.1	7.83	7.77
14	8.83	6.5	7.6	8.33	8.27
15	9.33	7.0	8.1	8.83	8.77
16	9.83	7.5	8.6	9.33	9.27
17	10.33	8.0	9.1	9.83	9.77
18	10.83	8.5	9.6	10.33	10.27
19	11.33	9.0	10.1	10.83	10.77
20	11.83	9.5	10.6	11.33	11.27
21	12.33	10.0	11.1	11.83	11.77
22	12.83	10.5	11.6	12.33	12.27
23	13.33	11.0	12.1	12.83	12.77
24	13.83	11.5	12.6	13.33	13.27
25	14.33	12.0	13.1	13.83	13.77
26	14.83	12.5	13.6	14.33	14.27
27	15.33	13.0	14.1	14.83	14.77
28	15.83	13.5	14.6	15.33	15.27
29	16.33	14.0	15.1	15.83	15.77
30	16.83	14.5	15.6	16.33	16.27
31	17.33	15.0	16.1	16.83	16.77
32	17.83	15.5	16.6	17.33	17.27
33	18.33	16.0	17.1	17.83	17.77
34	18.83	16.5	17.6	18.33	18.27
35	19.33	17.0	18.1	18.83	18.77
36	19.83	17.5	18.6	19.33	19.27
37	20.33	18.0	19.1	19.83	19.77
38	20.83	18.5	19.6	20.33	20.27
39	21.33	19.0	20.1	20.83	20.77
40	21.83	19.5	20.6	21.33	21.27
41	22.33	20.0	21.1	21.83	21.77
42	22.83	20.5	21.6	22.33	22.27
43	23.33	21.0	22.1	22.83	22.77
44	23.83	21.5	22.6	23.33	23.27
45	24.33	22.0	23.1	23.83	23.77
46	24.83	22.5	23.6	24.33	24.27
47	25.33	23.0	24.1	24.83	24.77
48	25.83	23.5	24.6	25.33	25.27
49	26.33	24.0	25.1	25.83	25.77
50	26.83	24.5	25.6	26.33	26.27

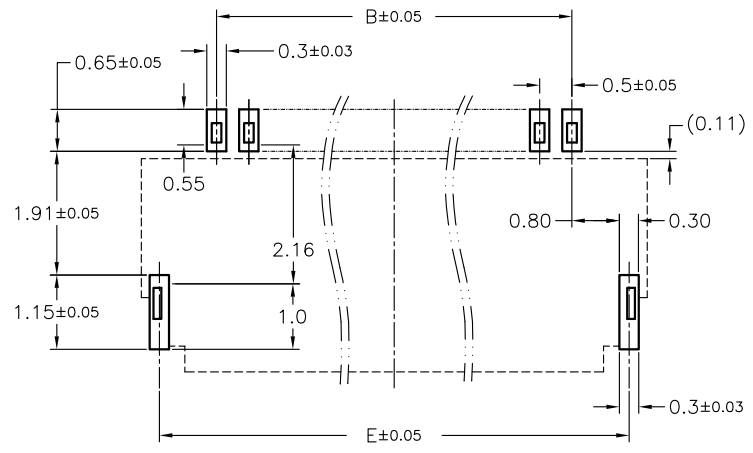

Recommended PCB Layout(Top View)
Recommended metal mask pattern(thickness 0.1mm)

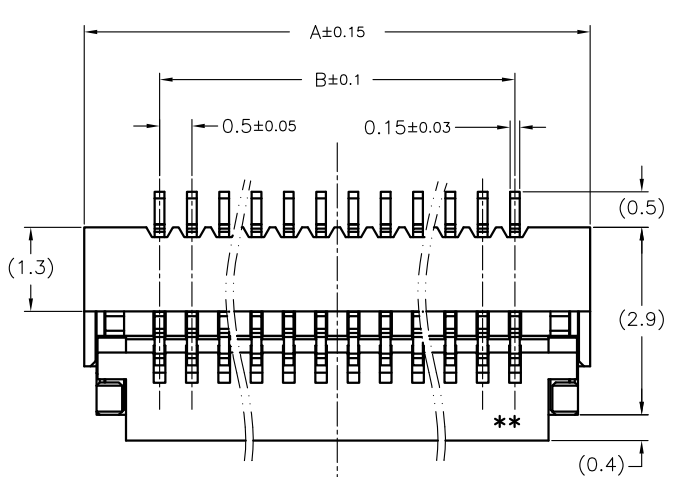
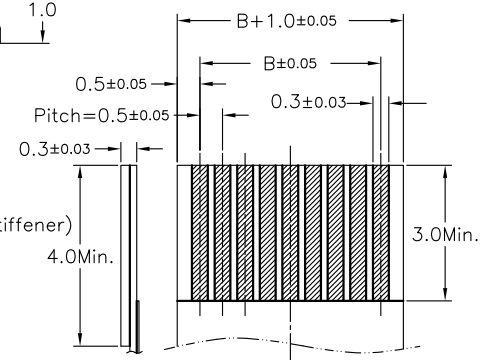
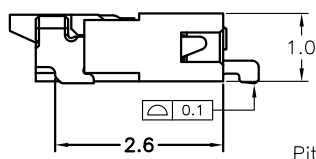
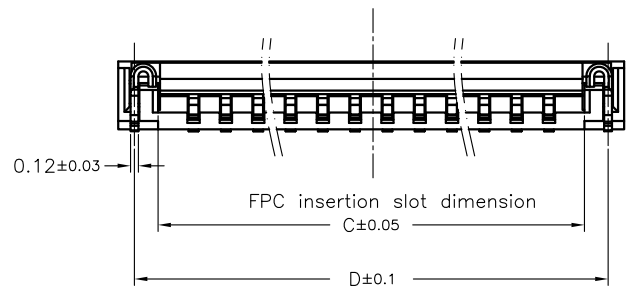

Recomenend FPC Dim.

- 技术指标 (Technical Index) :
1. 工作温度 (Temperature range) : -25° C-85° C.
 2. 额定电压 (Rated voltage) : 250V DC/AC (rms)
 3. 额定电流 (Rated current) : 5A AC, DC
 4. 接触阻抗 (CONTACT Resistance) : ≤25MΩ
 5. 耐压值 (Withstanding voltage) : 1500V AC/minute
 6. 绝缘阻抗 (Insulation resistance) ≥1000MΩ

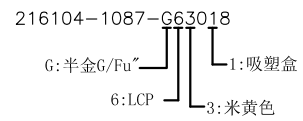
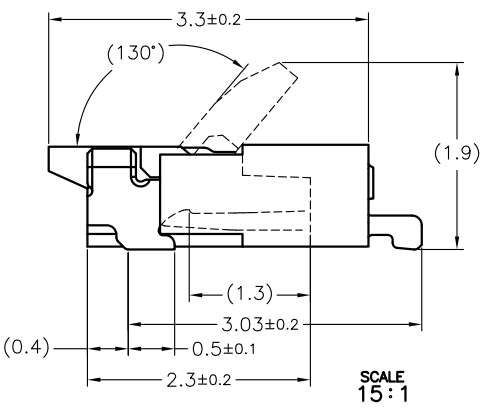

TOLERANCE UNLESS OTHERWISE SPECIFIED		深圳市华联威电子科技有限公司 HUA LIAN WEI TECHNOLOGY ELECTRONICS CO;LTD.			
.XXX ±0.10	.X' ±3'	PART NAME:	FPC1.1间距0.5 10P		
.XX ±0.20	.XX' ±2'	CHECKED	PART No:	216104-1087-G63018	C
.X ±0.30		DRAWN	yangguifeng	PROJECTION:	UNIT: SCALE SHEET REV.
DATE	2021.12.01			mm	1:1 1 OF 1 A