

承 认 书

Approval Sheet

客户 (Customer): /

客户料号 (Cus .P/N): /

华联威料号 (HLW P/N): SD5211-060-GBR

品名规格 (PronameSpec): SD CARD 卡座-SD 长卡铜 H 款

送样日期 (Delivery Date):2021/12/10

承认日期 (Acknowledge Date):2021/12/15

Approved No:		客 户 Customer	
采 购 部 Purchasing Dept	品 质 部 QC Dept	工 程 部 Engineering Dept	确 认 Approved By
深 圳 市 华 联 威 电 子 科 技 有 限 公 司 SHEN ZHEN SHI HUA LIAN WEI ELECTRONICS TECHNOLOGY CO; LTD.			
业 务 部 Sales Dept	品 管 部 QC Dept	工 程 部 Engineering Dept	核 准 Checked By
将成英	欠必锋	杨桂锋	唐竹君

地址:深圳市龙华区观澜街道桂香社区观澜桂花路 307 号

TEL: 0755-28888886 28888866

hua@hlwconn.com

[Http://www.hlwconn.com](http://www.hlwconn.com)

目 录

Contents

图纸.....	Page03
产品规格书.....	Page04-08
产品检测报告.....	Page09-10
尺寸测试报告.....	Page11
电镀报告.....	Page12-13
盐雾报告.....	Page14
材质证明.....	Page15-16
SGS.....	Page17-54

REV.	ECN.NO.	APPD.
A0	/	/

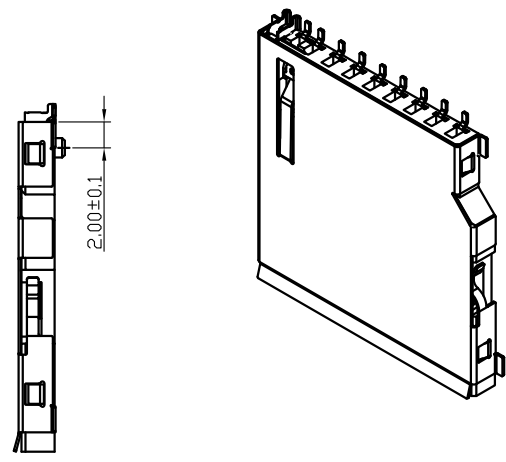
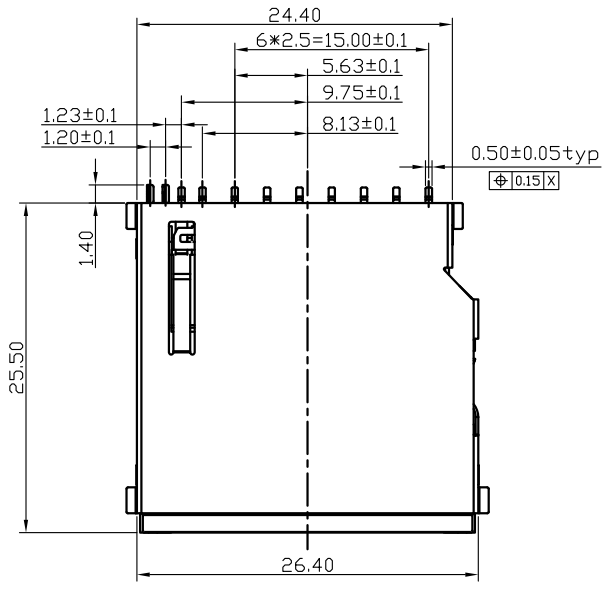

*Electrical Characteristics:
 Contact Current Rating:0.5 Amperes.
 Dielectric Withstanding Voltage:AC500V r.m.s.
 Insulation Resistance:1000 MΩ Minimum.
 Contact Resistance:100 mΩ Maximum.

*Environmental:
 Operating Temperature:-25°C~+90°C.

*Environmental:
 Mating Cycles:5000~10,000 Insertions.

*Mechanical Characteristics:
 Card Push Insertion/Out Force:1.4kgf. MAX
 Contact Separation Force:0.20kgf Minimum.

*Material:
 Insulator:HI-Temp Plastic UL 94V-O Rated.
 Contact:Copper Alloy(t=0.15mm).
 Shell:Stainless Steel(t=0.20mm).
 Spring:SWP.

SD5211-060-GBR

G: 半金G/Fu”
 R: RoHS
 B: LCP米黄色

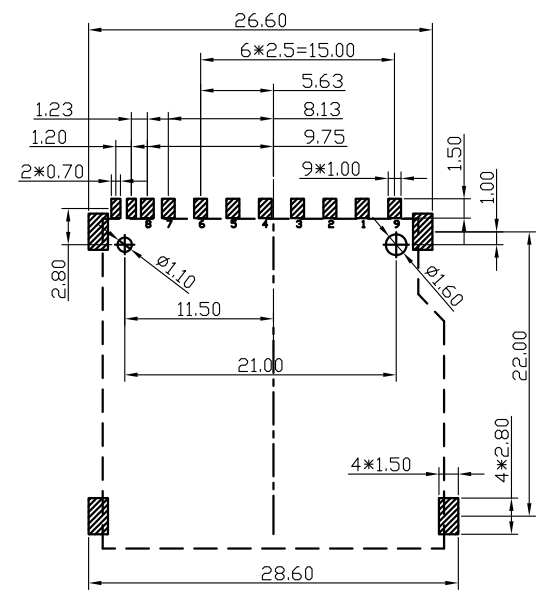
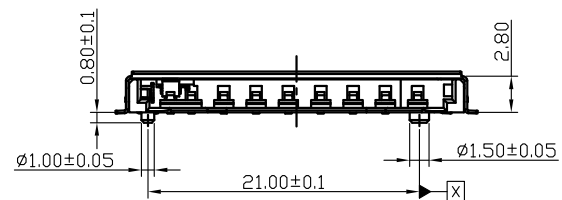

RECOMMENDED P.C.B HOLE LAYOUT
 COMPONENT SIDE VIEW(TOLERANCE: +/-0.05)

TOLERANCE UNLESS OTHERWISE SPECIFIED		FLW 深圳市华联威电子科技有限公司				
.XXX ±0.10 .XX ±0.20 .X ±0.30		.X ±3' .XX ±2'		HUA LIAN WEI TECHNOLOGY ELECTRONICS CO;LTD.		
APPROVED		PART NAME:	SD CARO 卡座-SD 长卡			
CHECKED		PART No:	SD5211-060-GBR			C
DRAWN	chenyiting	PROJECTION:	UNIT:	SCALE	SHEET	REV.
DATE	2023.04.19		mm	1:1	10F1	A0

深圳市华联威电子科技有限公司 PRODUCT SPECIFICATION 产品规格书	LANGUAGE 语言
	ENGLISH/CHINESE 英/中

1. SCOPE[适用范围]

This specification covers the TF CARD PUSH PUSH CONNECTOR SMT TYPE
 [本规范适用于 TF CARD PUSH PUSH CONNECTOR SMT TYPE]

2. PRODUCT NUMBER AND PART NAME[产品料号及产品名称]

Product Name[产品品名]	Product Number[产品料号]
TF CARD PUSH PUSH CONNECTOR SMT TYPE	C20**-0-****

3. CONSTRUCTION & COMPONENTS[构造&组成零件]

Based on construction drawing[依照工程图]

4. RATINGS[标准额定值]

Item[项目]	Standard[规格]
Rated voltage[额定电压]	30V AC
Rated current[额定电流]	0.5A
Operating temperature[使用温湿度环境]	-25℃~+85℃, 85% RH Max
Storage temperature[储存温湿度环境]	-40℃~+85℃, 85% RH Max

5. TEST CONDITION[试验条件]

The test and measurement, unless otherwise specified, shall be carry out at a temperature of 15 to 35℃,

Relative humidity of 25 to 85%, and atmospheric of 86 to 106kPa.

However, when any doubt arises on the judgment value it, the test and measurement shall be carry out at a temperature of 20±2℃, relative humidity of 60 to 70%, and atmospheric pressure of 86 to 106Pa.

[除非特别说明之外，一般试验及测理将于温度15~35℃，相对湿度25~85%，大气压力86~106kPa之条件下完成，但若于上述条件下有任何影响判定值的疑虑，可考量在温度20±2℃，相对湿度60~70%，大气压力86~106kPa之条件下完成试验

Appearance:By looking, there shall not be any abnormality such as deformity, exfoliation of plating, ETC, which can reduce performance, No defect such as cracks scratches or blemishes.
 [外观：经目视观察，外观不可有变形，电镀脱落等会降低其功能的异常现象，也不可有严重破裂，刮伤或污损之缺点.]

P/N:C20**-0-**** 料号:		TITLE: TF CARD PUSH PUSH CONNECTOR SMT TYPE 品名:	
SHEET 页码	2/6	REV./版本	A0

深圳市华联威电子科技有限公司 PRODUCT SPECIFICATION 产品规格书	LANGUAGE 语言
	ENGLISH/CHINESE 英/中

6. ELECTRICAL EFFICIENCY [电气特性]

NO. 编号	Item/项目	Test Method/试验方法	Requirement /性能要求
6.1	Contact Resistance [接触阻抗]	Mate connectors, Measure by dry circuit, 20mV Max, 100mA [公母对插后测试] {EIA-364-23}	contact pin: 100mΩ Max 100mΩ 以下
6.2	Insulation Resistance [绝缘阻抗]	Unmated connectors, apply 500V DC between adjacent terminal or ground. [公母不对插, 对相邻端子施加500V DC电压测试] {EIA-364-21}	100MΩ Min (unmated)
6.3	Withstanding Voltage [耐电压]	Unmated connectors, apply 500V AC for 1 minute between adjacent terminal or ground. [公母对插前对各端子施加500V AC电压持续1分钟测试.] {EIA-364-20}	No Breakdown Current leakage: 1mA Max. 无击穿 漏电流: 1mA以下

7. MECHANICAL EFFICLENCY [机械特性]

7.1	Mating force [插入力]	Measure mating force necessary to mate connector. Operation speed: 25mm/minute [测试一组公母对插之连接器所需之插入力, 测试速度25mm/分钟] {EIA-364-13}	0.5 Kgf (4.9 N)~1.2 Kgf (11.76 N)	
7.2	Card Ejection Force [退卡弹力]	EIA 364-13 Shall be measured with TENSION GAUGE or TENSION TESTER Measure force necessary to mate samples at maximum rate of 25.4mm per minute	0.5 Kgf (4.9 N)~1.2 Kgf (11.76 N)	
7.3	Contact retention [端子保持力]	Apply axial pull out force on the terminal assembled in the housing Operation speed: 25mm/minute [测试将端子由本体中拉出之保持力, 测试速度25mm/分钟]	1.47N {0.15kgf} Min. 1.47N {0.15kgf} 以上	
7.4	Durability [耐久性]	Mated and unmated connectors up to 10000 cycles at a rate of 400~600 cycles per hour [连接器在400~600次/小时的插拔速度下必须承受10000次的插拔循环]	Contact Resistance 接触阻抗	ΔR=40mΩ Max ΔR=40mΩ 以下

P/N: C20**-0-**** 料号:		TITLE: TF CARD PUSH PUSH CONNECTOR SMT TYPE 品名:		
SHEET 页码	3/6	REV. /版本	A0	

深圳市华联威电子科技有限公司 PRODUCT SPECIFICATION 产品规格书	LANGUAGE 语言 ENGLISH/CHINESE 英/中
--	--

8. ENVIRONMENTAL EFFICIENCY AND OTHERS [环境及其它特性]

NO. 编号	Item/项目	Test Method/试验方法	Requirement /性能要求	
8.1	Humidity Test [耐湿性测试]	Temperature:60±2℃, Relative Humidity:90% Duration:96 hours Upon completion of the test,specimens shall be conditioned at ambient room conditions for 1~2 hours [温度在60±2℃,相对湿度90%,持续96小时,经试验后,连接器于室温中放置1~2小时再测试其它值] {EIA-364-31 Test condition A method III}	Appearance 外观	NO damage 不可破坏
			Contact Resistance 接触阻抗	ΔR=40mΩ Max ΔR=40mΩ 以下
			Insulation Resistance 绝缘阻抗	100MΩ Min. 100MΩ 以上
8.2	Salt mist spray [盐水喷雾测试]	Salt concentration:5%; Temperature:35±2℃; Testing time:8 hours After salt is removed by running water and a drop is removed,it is measured. [盐水比重:5%,温度:35±2℃,试验时间72小时,试验后用清水将残留盐份清洗,并将水滴清除后,方可再测试其它值] {EIA-364-26A,condition A}	Appearance 外观	NO damage 不可破坏
			Contact Resistance 接触阻抗	ΔR=40mΩ Max ΔR=40mΩ 以下
8.3	Vibration (Low frequency) [振动测试] (低周波)	Amplitude:1.52mm. Sweep time:10~55~10Hz Duration:2 hours in each X,Y,Z azes. (total of 6 hours) Electrical load:10mA [振幅:1.52mm,振动频率:10~55~10Hz,振动时间:X、Y、Z轴各2小时共计6小时,载入电流:10mA] {EIA-364-28 Test condition V test letter A}	Appearance 外观	NO damage 不可破坏
			Contact Resistance 接触阻抗	ΔR=40mΩ Max ΔR=40mΩ 以下
			Discontinuity 瞬断	1 μ Sec. Max
8.4	Dropping Test [跌落测试]	Status:One carton of products Dropping plane:The wood block(or the coordinate condition) Height:1.5m Directions:Each of X,Y, and Z-axes directions No of times: each two times Dropping way:dropped normally [状态:运输包装状态,落下平面:坚固地面,落下高度:1.5m,落下方向:X-Y-Z,次数:各2次,落下方法:自由落下]	Appearance 外观	NO damage 不可破坏
8.5	Thermal shock [冷热冲击测试]	Mated connentor with dummy card and perform the test as follows. 25 cycle of: A)-25℃ for 30 minutes; B)+85℃ for 30 minutes [将连接器与仿真卡对插后,做25个循环,每个循环条件为:-25℃,30分钟;+85℃,30分钟] {EIA-364-32, Condition I}	Appearance 外观	NO damage 不可破坏
			Contact Resistance 接触阻抗	ΔR=40mΩ Max ΔR=40mΩ 以下
8.6	Heat test [耐热性测试]	Mated connentor with dummy card, test on 85℃ for 96 hours. After testing it shall be left alone for 1 to 2 hours in room ambient. [将连接器与仿真卡对插后,测试条件:温度85℃,时间96小时;结束后将其放置于室温下1~2小时再测试其他值]	Appearance 外观	NO damage 不可破坏
			Contact Resistance 接触阻抗	ΔR=40mΩ Max ΔR=40mΩ 以下

P/N: C20**-0-**** 料号:		TITLE: TF CARD PUSH PUSH CONNECTOR SMT TYPE 品名:	
SHEET 页码	4/6	REV./版本	A0

深圳市华联威电子科技有限公司 PRODUCT SPECIFICATION 产品规格书	LANGUAGE 语言
	ENGLISH/CHINESE 英/中

8. ENVIRONMENTAL EFFICIENCY AND OTHERS [环境及其它特性]

NO. 编号	Item/项目	Test Method/试验方法	Requirement /性能要求	
			Appearance 外观	NO damage 不可破坏
8.7	Cold test [耐寒性测试]	Mated connentor with dummy card, test on -40℃ for 96 hours. After testing it shall be left alone for 1 to 2 hours in room ambient. [将连接器与仿真卡对插后, 测试条件: 温度-25℃, 时间96小时; 结束后将其放置于室温下1~2小时再测试其他值]	Appearance 外观	NO damage 不可破坏
			Contact Resistance 接触阻抗	$\Delta R=40m\Omega$ Max $\Delta R=40m\Omega$ 以下
8.8	Solderability [焊锡性测试]	Soldering time:3 second Max. (Use flux) Solder Temperature:255±2℃ [焊锡时间: 5秒以下(使用助焊剂), 焊锡温度: 255±2℃ {EIA-364-52}]	95% min. of soder area [焊锡面积最小95%]	
8.9	Resistance to Soldering Heat [焊锡耐热性]	Soldering Iron method Using the soldering iron, and the cored solder wire. It is applied to termination for 3+1/-0s at 350±5℃. [手工焊接] [使用烙铁和芯线, 焊锡温度为255±5℃, 时间为3+1/-0s]	Appearance 外观	NO damage 不可破坏
		IR-reflow Soldering method Test connector on PCB. Pre-heat: 160~190℃; 120seconds Heat: 230℃ Min; 40seconds Heat Peak: 250℃ Max [回流焊接] [组装在PCB上做测试, 预热: 160~190℃; 120秒; 加热: 230℃以上; 40秒 最高温度: 250℃以下]	Appearance 外观	NO damage 不可破坏

Temperature Profile IR-Reflow Soldering:

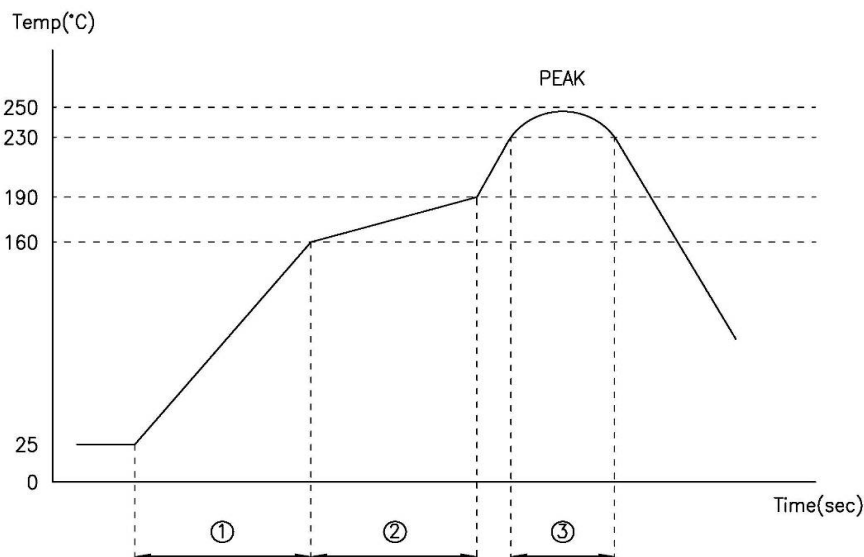

Pre-Heating Zone ①; Temperature rise 1~4℃/sec	① 预热部分: 升温1~4℃/sec
Pre-Heating Zone ②; 160~190℃ 120sec	② 预热部分: 160~190℃ 120sec以内
Soldering Zone ③; Forty seconds over 230℃	③ 焊锡加热部分: 230℃以上 40sec以内
PEAK temperature; Below 250℃	PEAK温度: 250℃以下

P/N: C20**-0-**** 料号:		TITLE: TF CARD PUSH PUSH CONNECTOR SMT TYPE 品名:	
SHEET 页码	5/6	REV. /版本	A0

深圳市华联威电子科技有限公司 PRODUCT SPECIFICATION 产品规格书	LANGUAGE 语言
	ENGLISH/CHINESE 英/中

9. TEST SEQUENCES [测试顺序]

Test or Examination 测试/检查		Test Group 测试组别										
NO.	Item/项目	A	B	C	D	E	F	G	H	I	J	K
XX	Examination of product/产品确认	1	1	1, 6	1, 5	1, 5	1, 3	1, 5	1, 5	1, 5	1	1, 3
6. 1	Contact Resistance/接触阻抗	2	2, 6	2, 4	2, 4	2, 4		2, 4	2, 4	2, 4		
6. 2	Insuation Resistance/绝缘阻抗	3		5								
6. 3	Withstanding Voltage/耐电压	4										
7. 1	Insertion force/插入力		3									
7. 2	Push in strength/弹簧弹力		4									
7. 3	Contact retention/端子保持力	5										
7. 4	Durability/耐久性		5									
8. 1	Humidity Test/耐湿性测试			3								
8. 2	Salt mist spray/盐水喷雾测试				3							
8. 3	Vibration/振动测试					3						
8. 4	Dropping Test/跌落测试						2					
8. 5	Thermal shock/冷热冲击测试							3				
8. 6	Heat test/耐热性测试								3			
8. 7	Cold test/耐寒性测试									3		
8. 8	Solderability/焊锡性测试										2	
8. 9	Resistance to Soldering Heat 焊锡耐热性											2

P/N: C20**-0-**** 料号:		TITLE: TF CARD PUSH PUSH CONNECTOR SMT TYPE 品名:	
SHEET 页码	6/6	REV. /版本	A0



測試報告

TEST REPORT

產品名稱 Part	SD CARD 卡座-SD 长卡铜 H款	測試日期 Date of Testing	2021. 12. 10- 2021. 12. 15	報告編號 Report NO.	MD20211216-05
產品型號 Part	SD5211-060-GBR	樣品數量 Quantity	5PCS	測試環境 Date of Testing	濕度 Temp: 18~21°C 相 對濕度 R.H. : 49%~57%

一. 電性測試 ELECTRICAL TEST

序號 NO	測試項目 Testing Item	測試條件 Testing Conditions	測試設備 Testing Equipments	規格 SPEC	測試記錄Testing Result					判定 Judge	
					1	2	3	4	5	OK	NG
1	接觸阻抗	100 m Ohm	直流低電阻測試儀	100 m Ohm Max	90.2m Ohm Ω	89.8m Ohm Ω	91.5m Ohm Ω	92.0m Ohm Ω	98.53m Ohm Ω	V	
2	絕緣阻抗	1000 M Ohm VDC	絕緣電阻測試儀	1000 M Ohm Min	Pass	Pass	Pass	Pass	Pass	V	
3	耐壓測試	500V AC / 0.5 mA 1分钟	耐壓測試儀	No damaged	OK	OK	OK	OK	OK	V	

二. 机械特性測試 MECHANICAL TEST

序號 NO	測試項目 Testing Item	測試條件 Testing Conditions	測試設備 Testing Equipments	規格 SPEC	測試記錄Testing Result					判定 Judge	
					1	2	3	4	5	OK	NG
4	插入力	每分钟25±3mm 的速度	插拔力計	40 Max.	36N	35N	32N	30N	29N	V	
5	拔出力	每分钟25±3mm 的速度	插拔力計	1N Min	1.2N	1.4N	1.5N	1.1N	1.3N	V	
6	耐久性	测试速度：每分 钟5个 循环，测试次 数：5000次循 环最少	插拔力計	不得发生物理 损坏。	OK	OK	OK	OK	OK	V	

三. 环境特性测试 ENVIRONMENTAL TEST

序號 NO	測試項目 Testing Item	測試條件 Testing Conditions	測試設備 Testing Equipments	規格 SPEC	測試記錄Testing Result					判定 Judge	
					1	2	3	4	5	OK	NG
7	冷热冲击	55+/-3°C (30 分 钟), +85+/- 2°C (30 分 钟) 为一个中期的环 境中, 重复 10 个周期	高低温试 验箱	不得发生物理 损坏。	OK	OK	OK	OK	OK	V	

8	湿温循环	温度25~65℃， 湿90~95%，持 续时间:4qw	湿温循环 机	最大接触阻抗 30mΩ	OK	OK	OK	OK	OK	V	
9	盐雾试验	温度:35±2℃ 12小时	盐雾试验 箱	最大接触阻抗 50mΩ	OK	OK	OK	OK	OK	V	
10	可焊性	焊锡温度: 245±5℃	熔锡炉	沾锡面积达 90%以上	OK	OK	OK	OK	OK	V	
11	焊接耐热试 验	260±5℃ 10秒	工业烘烤 箱	不得发生物理 损坏	OK	OK	OK	OK	OK	V	
綜合判定TEST JUDGMENT		<input checked="" type="checkbox"/> 合格 (Acceptable) <input type="checkbox"/> 不合格 (Reject)									



深圳市华联威电子科技有限公司

檢驗報告

首件檢驗
 入庫檢驗
 出貨檢驗
 客退檢驗
 退料檢驗
 其他
 2021年12月15日 版次:A1

料號	SD5211-060-GBR		制令單號	/		送檢單位	工程		首件製作者	裝配			
品名	SD CARD 卡座-SD 长卡铜 H款		客戶代號	/		批 量	/		送檢時間	/			
						數 量	5PCS		確認時間	/			
抽樣標準			<input checked="" type="checkbox"/> 單次 <input type="checkbox"/> 雙次			抽樣數 (5PCS)	AQL	CRI:0	MAJ:0.4	MIN:0.65			
MIL-STD-105E(II)			<input checked="" type="checkbox"/> 正常 <input type="checkbox"/> 加嚴 <input type="checkbox"/> 減量				ACC/REJ	0	/	/			
不良數:			CRI (/)		MAJ (/)		MIN (/)		不良率(%)		/		
NO.	檢驗項目 單位:MM/G	檢測 儀器	檢 驗 記 錄					品管判定		CRI	MAJ	MIN	備注
			1	2	3	4	5	AC	RE				
尺 寸 測 量	1.00±0.05	D	1.02	0.98	0.98	0.99	0.97	√					
	21.00±0.10	D	21.01	21.05	20.98	20.95	20.97	√					
	1.50±0.5	D	1.52	1.49	1.48	1.54	1.54	√					
	2.80±0.20	D	2.82	2.84	2.83	2.78	2.79	√					
	0.80±0.10	D	0.83	0.85	0.89	0.84	0.86	√					
	2.00±0.10	D	2.03	1.98	1.97	2.05	2.03	√					
	26.40±0.20	D	26.44	26.42	26.40	26.38	26.39	√					
	25.50±0.20	D	25.58	25.55	25.53	25.60	25.54	√					
	24.40±0.20	D	24.42	24.38	24.37	24.43	24.46	√					
	1.40±0.20	D	1.42	1.48	1.50	1.46	1.45	√					
	0.50±0.05	D	0.49	0.51	0.42	0.43	0.46	√					
	1.20±0.20	D	1.23	1.24	1.18	1.16	1.17	√					
	1.23±0.20	D	1.20	1.22	1.19	1.17	1.24	√					
	2.50±0.10	D	2.52	2.48	2.46	2.53	2.56	√					
檢驗依據: <input checked="" type="checkbox"/> 《工程圖紙》 <input type="checkbox"/> 《檢驗規範》 <input type="checkbox"/> 《承認書》 <input type="checkbox"/> 樣品 <input type="checkbox"/> 其它													
檢測儀器:A游標卡尺 B千分尺 C厚薄儀 D投影鏡 E放大鏡 F顯微鏡 G錫爐 H插拔力器 I間位尺 J其它													
品保判定:			<input checked="" type="checkbox"/> 合格Accept <input type="checkbox"/> 退貨Reject <input type="checkbox"/> 特采Waive <input type="checkbox"/> 挑選Sort										

核准: 欠必鋒

審核: 刘联英

檢驗員: 但芬



电镀报告表

品名:SD CARD 卡座-SD 长卡铜 H款 (外壳)	版次:A.0
------------------------------	--------

电镀规格:Ni:50u" min	日期:2021/12/10	页次:1/1
------------------	---------------	--------

厂商:金和源

测试设备:CMI X-射线膜厚测试仪

1、表层电镀测试 (Ni)

数据	测试标准	实测值	判定	测试日期	测试时间
1	50u"min	55.3u"	OK	2021/12/10	10:42:14
2	50u"min	57.6u"	OK	2021/12/10	10:42:16
3	50u"min	56.4u"	OK	2021/12/10	10:42:18
4	50u"min	52.5u"	OK	2021/12/10	10:42:20

核准: 欠必锋

审核: 刘联英

检验员: 但芬

盐水喷雾实验报告

试验方法	盐水喷雾腐蚀试验法	参考资料	MIL-STD-1216
METHOD	NEUTRL SALT SPRAY CORROSION TEST	REF	
客户	/	试验起始日期	2021年12月14日 08:00 时起
		DATE	2021年12月15日 20:00 时止
样品名称	SD CARD 卡座-SD 长卡铜 H款	试验数量	5PCS
P/N	SD5211-060-GBR		

试验条件 (TEST CONDITON)

- 1、盐水溶解 (SALT SOLUTION: 浓度 $50 \pm 10\text{g/L}$, PH值6.5-7.2).
- 2、试验室温度 (TEMP. IT THE SPRAY DHAMBR): $35 \pm 1^\circ\text{C}$.
- 3、盐水桶温度 (TEMP. OF SALE SOL' N TANK): $35 \pm 1^\circ\text{C}$.
- 4、压力桶温度 (TEMP. OF SAR SUPPLIERY): $47 \pm 1^\circ\text{C}$.
- 5、试验室相对湿度 (R. H IN THE CHAMBER) 85%.
- 6、压缩空气压力 (COMPRESSED AIR PRESSURE): $1.00 \pm 0.01\text{Kg/cm}^2$.
- 7、样品放置位置 (SPECIMEN SUPPORTED ANGLE): 尼龙绳吊挂 $70^\circ - 90^\circ$.
- 8、喷雾收集量 (COLLECT RATE OF SALT SOL' N) $1-2\text{mL}/(8 \text{ cm}^2\text{hr})$.
- 9、盐雾测试时间: 12小时 (H)

判定方法 (ADFUSGD METHOD)

试验后以20倍放大镜观察、无蓝、绿色腐蚀物之现象 (不包含折弯处), 即判定合格. (Inspext the ecimen at 20 xmagnification no blue or green corrosion products are acceptable)

样品序号	试验后现象	判定
	PHENOMENON AFTER TEST	COMMENT
1	无蓝、绿色腐蚀物之现象	OK
2	无蓝、绿色腐蚀物之现象	OK
3	无蓝、绿色腐蚀物之现象	OK
4	无蓝、绿色腐蚀物之现象	OK
5	无蓝、绿色腐蚀物之现象	OK

核准: 欠必锋

审核: 刘联英

试验员: 但芬

鉅鼎銅材廠檢驗報告單

公司名稱 Customer	鉅鼎銅材廠檢驗報告單				重量 Weight(kg)	1078	出貨日期 Date	2021/11/23		
品名 Article	標準 Standard No				尺寸 Dimension		狀態 Temper	銅卷編號 Coil No		
C2680	JISH3100:2017				0.18*400		EH	1021-C-08		
化學成分Chemical Compositions(%)										
元素 Element	Cu %	Zn%	Pb%	Fe%	\	\	\	\	化學成分	雜質
規範 Spec	64.0-68.0	餘量	<0.05	<0.05	\	\	\	\	合格	合格
實測 Actual	64.32	餘量	0.0036	0.0136	\	\	\	\	合格	合格
機械性質Mechanical Properties										
項目 Item	結晶粒度 Grain Size Mm	硬度 Hardness Hv	抗拉強度 TensionStrength Mpa	伸長度 Elongation %	導電率 Electrical Conduc %IACS	彎曲試驗 Bending Test 180	表面粗度 Surface Roughness Ra(u m)	彎曲度 Camber mm/n		
規範MAX Spec	\	170-190	490-610	\	\	\	\	\		
實測 Actual	\	178	574	5	\	\	\	\		

品質部



Materials Information

PRODUCT NAME: LCP M-401 BK

COMPOSITION/INFORMATION OF LCP M-401 BK

SUBSTANCE/MIXTURE: Mixture

SYNONYM(S): Aromatic Liquid Crystal Polymer(LCP)

品名	比例	用途
德众泰 LCP 树脂	0.565	构成材料主要成分
抗氧化剂	0.002	抗氧化
科莱恩热稳定剂	0.003	增加高温稳定性
黑色母	0.01	着色
滑石粉	0.2	增强剂, 增加流动性
玻纤	0.22	增强

NAME OF COMPANY: DZT Engineering Plastics Tech. Co.,Ltd

ADDRESS: Building 2 Zhichong Industrial Park, Hi-Tech Zone, Jiangmen City,
Guangdong Province, China

SECTION IN CHARGE: Quality Assurance Department

TEL/FAX: +86-750-3689920/+86-750-3689921

EMERGENCY TEL: +86-750-3689708



Test Report

No. CANEC2222380701

Date: 26 Oct 2022

Page 1 of 4

Client Name : SHENZHEN HUALIANWEI ELECTRONICS TECHNOLOGY CO.,LTD

Client Address : 101, 201, PLANT 1, NO.307, GUANLAN GUIHUA ROAD, GUIXIANG COMMUNITY, GUANLAN SUB-DISTRICT, LONGHUA DISTRICT, SHENZHEN CITY, GUANGDONG PROVINCE, CHINA

Sample Name : C2680 Terminal

Model No. : C2680 terminal after plating

Client Ref. Info. : Used for USB series, HDMI series, RJ series, 1394 series, MICRO series, MINI series, DISPLAYPORT series, VGA series, DVI series, TYPE-C series, JACK series

The above sample(s) and information were provided by the client.

SGS Job No. : CP22-057100 - GZ

Date of Sample Received : 20 Oct 2022

Testing Period : 20 Oct 2022 - 26 Oct 2022

Test Requested : Selected test(s) as requested by the client.

Test Method(s) : Please refer to next page(s).

Test Result(s) : Please refer to next page(s).

Result Summary :

Test Requested	Conclusion
EU RoHS Directive (EU) 2015/863 amending Annex II to Directive 2011/65/EU- Lead, Mercury, Cadmium and Hexavalent chromium	PASS

Signed for and on behalf of
SGS-CSTC Standards Technical Services Co., Ltd. Guangzhou Branch

Dongyu Xie

Dongyu Xie
Approved Signatory

scan to see the report



A17521CE



SGS-CSTC Standards Technical Services Co., Ltd.
Guangzhou Branch Testing Center Chemical Laboratory

Unless otherwise agreed in writing, this document is issued by the Company subject to its General Conditions of Service printed overleaf, available on request or accessible at <http://www.sgs.com/en/Terms-and-Conditions.aspx> and, for electronic format documents, subject to Terms and Conditions for Electronic Documents at <http://www.sgs.com/en/Terms-and-Conditions/Terms-e-Document.aspx>. Attention is drawn to the limitation of liability, indemnification and jurisdiction issues defined therein. Any holder of this document is advised that information contained hereon reflects the Company's findings at the time of its intervention only and within the limits of Client's instructions, if any. The Company's sole responsibility is to its Client and this document does not exonerate parties to a transaction from exercising all their rights and obligations under the transaction documents. This document cannot be reproduced except in full, without prior written approval of the Company. Any unauthorized alteration, forgery or falsification of the content or appearance of this document is unlawful and offenders may be prosecuted to the fullest extent of the law. Unless otherwise stated the results shown in this test report refer only to the sample(s) tested.

Attention: To check the authenticity of testing /inspection report & certificate, please contact us at telephone: (86-755) 8307 1443, or email: CN.Doccheck@sgs.com

198 Kezhu Road, Sciencetech Park Guangzhou Economic & Technology Development District, Guangzhou, China 510663

中国·广州·经济技术开发区科学城科珠路198号 邮编: 510663

t (86-20) 82155555 www.sgs.com

t (86-20) 82155555 sgs.china@sgs.com

Test Report

No. CANEC2222380701

Date: 26 Oct 2022

Page 2 of 4

Test Result(s) :

Test Part Description :

Specimen No.	SGS Sample ID	Description
SN1	CAN22-223807.001	Silver-grey/brassy metal

Remarks :

- (1) 1 mg/kg = 0.0001%
- (2) MDL = Method Detection Limit
- (3) ND = Not Detected (< MDL)
- (4) "-" = Not Regulated

EU RoHS Directive (EU) 2015/863 amending Annex II to Directive 2011/65/EU- Lead, Mercury, Cadmium and Hexavalent chromium

Test Method : With reference to IEC 62321-4:2013+A1:2017, IEC 62321-5:2013, IEC 62321-7-1:2015, analyzed by ICP-OES and UV-Vis .

<u>Test Item(s)</u>	<u>Limit</u>	<u>Unit</u>	<u>MDL</u>	<u>001</u>
Cadmium (Cd)	100	mg/kg	2	ND
Lead (Pb)	1000	mg/kg	2	3
Mercury (Hg)	1000	mg/kg	2	ND
Hexavalent Chromium (Cr(VI))▼	-	µg/cm ²	0.10	ND

Notes :

- (1) The maximum permissible limit is quoted from RoHS Directive (EU) 2015/863.
 - (2) IEC 62321 series is equivalent to EN 62321 series
 - (3) ▼= a. The sample is positive for CrVI if the CrVI concentration is greater than 0.13 µg/cm². The sample coating is considered to contain CrVI
 b. The sample is negative for CrVI if CrVI is ND (concentration less than 0.10 µg/cm²). The coating is considered a non-CrVI based coating
 c. The result between 0.10 µg/cm² and 0.13 µg/cm² is considered to be inconclusive - unavoidable coating variations may influence the determination
- Information on storage conditions and production date of the tested sample is unavailable and thus Cr(VI) results represent status of the sample at the time of testing.

Unless otherwise stated, the decision rule for conformity reporting is based on Binary Statement for Simple Acceptance Rule (w=0) stated in ILAC-G8:09/2019.



Unless otherwise agreed in writing, this document is issued by the Company subject to its General Conditions of Service printed overleaf, available on request or accessible at <http://www.sgs.com/en/Terms-and-Conditions.aspx> and, for electronic format documents, subject to Terms and Conditions for Electronic Documents at <http://www.sgs.com/en/Terms-and-Conditions/Terms-e-Documents.aspx>. Attention is drawn to the limitation of liability, indemnification and jurisdiction issues defined therein. Any holder of this document is advised that information contained hereon reflects the Company's findings at the time of its intervention only and within the limits of Client's instructions, if any. The Company's sole responsibility is to its Client and this document does not exonerate parties to a transaction from exercising all their rights and obligations under the transaction documents. This document cannot be reproduced except in full, without prior written approval of the Company. Any unauthorized alteration, forgery or falsification of the content or appearance of this document is unlawful and offenders may be prosecuted to the fullest extent of the law. Unless otherwise stated the results shown in this test report refer only to the sample(s) tested.

Attention: To check the authenticity of testing /inspection report & certificate, please contact us at telephone: (86-755) 8307 1443, or email: CN.Doccheck@sgs.com

ATTACHMENTS

Pb/Cd/Hg/Cr⁶⁺ Testing Flow Chart

1) These samples were dissolved totally by pre-conditioning method according to below flow chart. (Cr⁶⁺ test method excluded).

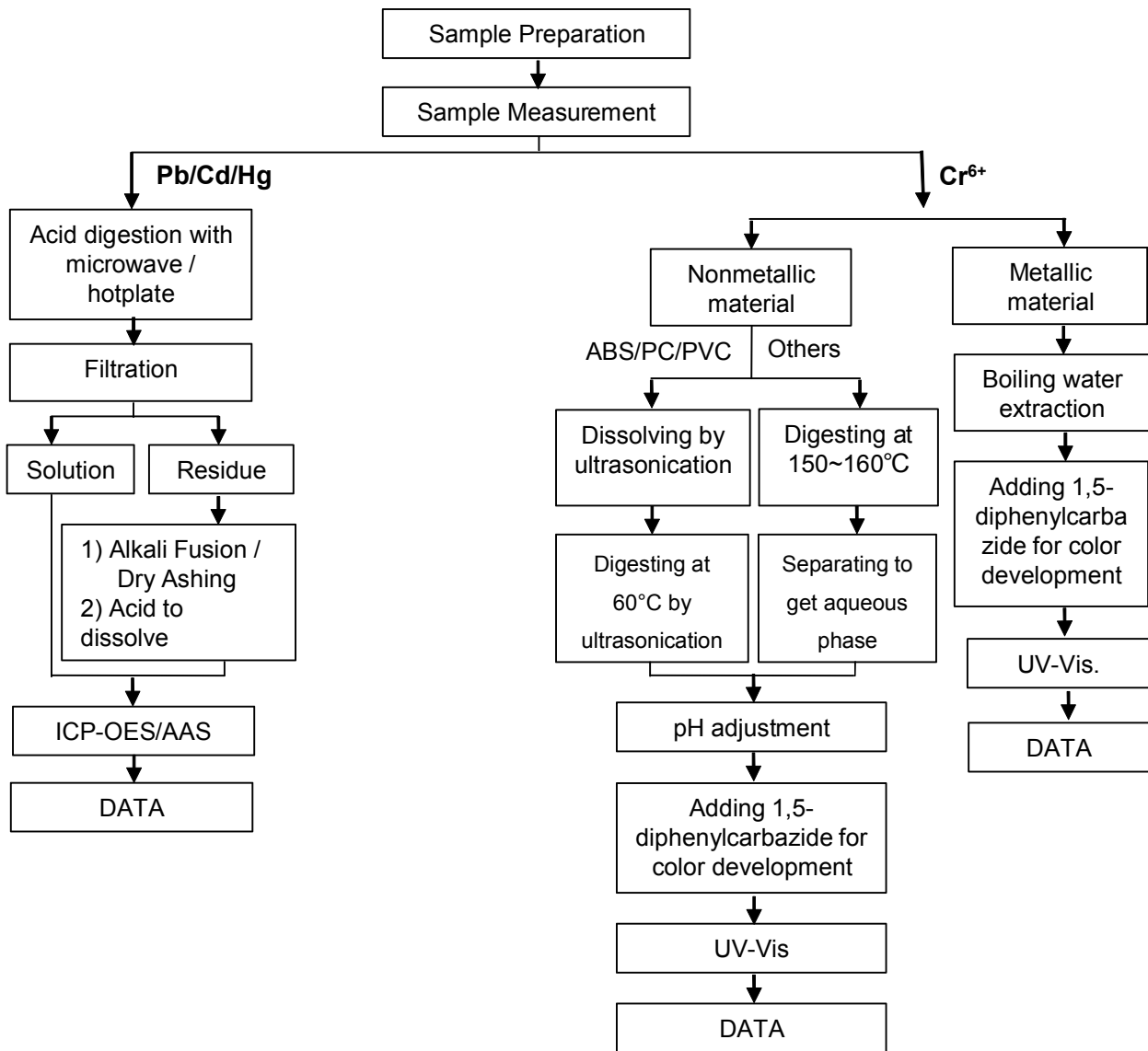

Unless otherwise agreed in writing, this document is issued by the Company subject to its General Conditions of Service printed overleaf, available on request or accessible at <http://www.sgs.com/en/Terms-and-Conditions.aspx> and, for electronic format documents, subject to Terms and Conditions for Electronic Documents at <http://www.sgs.com/en/Terms-and-Conditions/Terms-e-Documents.aspx>. Attention is drawn to the limitation of liability, indemnification and jurisdiction issues defined therein. Any holder of this document is advised that information contained hereon reflects the Company's findings at the time of its intervention only and within the limits of Client's instructions, if any. The Company's sole responsibility is to its Client and this document does not exonerate parties to a transaction from exercising all their rights and obligations under the transaction documents. This document cannot be reproduced except in full, without prior written approval of the Company. Any unauthorized alteration, forgery or falsification of the content or appearance of this document is unlawful and offenders may be prosecuted to the fullest extent of the law. Unless otherwise stated the results shown in this test report refer only to the sample(s) tested.

Attention: To check the authenticity of testing / inspection report & certificate, please contact us at telephone: (86-755) 8307 1443, or email: CN.Doccheck@sgs.com

Sample photo:



SGS authenticate the photo on original report only

*** End of Report ***



Test Report

No. CANEC2222380702

Date: 26 Oct 2022

Page 1 of 4

Client Name : SHENZHEN HUALIANWEI ELECTRONICS TECHNOLOGY CO.,LTD

Client Address : 101, 201, PLANT 1, NO.307, GUANLAN GUIHUA ROAD, GUIXIANG COMMUNITY, GUANLAN SUB-DISTRICT, LONGHUA DISTRICT, SHENZHEN CITY, GUANGDONG PROVINCE, CHINA

Sample Name : C2680 Copper shell

Model No. : C2680 shell after plating

Client Ref. Info. : Used for USB series, HDMI series, RJ series, 1394 series, MICRO series, MINI series, DISPLAYPORT series, VGA series, DVI series, TYPE-C series, JACK series

The above sample(s) and information were provided by the client.

SGS Job No. : CP22-057100 - GZ

Date of Sample Received : 20 Oct 2022

Testing Period : 20 Oct 2022 - 26 Oct 2022

Test Requested : Selected test(s) as requested by the client.

Test Method(s) : Please refer to next page(s).

Test Result(s) : Please refer to next page(s).

Result Summary :

Test Requested	Conclusion
EU RoHS Directive (EU) 2015/863 amending Annex II to Directive 2011/65/EU- Lead, Mercury, Cadmium and Hexavalent chromium	PASS

Signed for and on behalf of
SGS-CSTC Standards Technical Services Co., Ltd. Guangzhou Branch

Dongyu Xie

Dongyu Xie
Approved Signatory

scan to see the report



E0D80CC0



SGS-CSTC Standards Technical Services Co., Ltd.
Guangzhou Branch Testing Center Chemical Laboratory

Unless otherwise agreed in writing, this document is issued by the Company subject to its General Conditions of Service printed overleaf, available on request or accessible at <http://www.sgs.com/en/Terms-and-Conditions.aspx> and, for electronic format documents, subject to Terms and Conditions for Electronic Documents at <http://www.sgs.com/en/Terms-and-Conditions/Terms-e-Documents.aspx>. Attention is drawn to the limitation of liability, indemnification and jurisdiction issues defined therein. Any holder of this document is advised that information contained hereon reflects the Company's findings at the time of its intervention only and within the limits of Client's instructions, if any. The Company's sole responsibility is to its Client and this document does not exonerate parties to a transaction from exercising all their rights and obligations under the transaction documents. This document cannot be reproduced except in full, without prior written approval of the Company. Any unauthorized alteration, forgery or falsification of the content or appearance of this document is unlawful and offenders may be prosecuted to the fullest extent of the law. Unless otherwise stated the results shown in this test report refer only to the sample(s) tested.

Attention: To check the authenticity of testing / inspection report & certificate, please contact us at telephone: (86-755) 8307 1443, or email: CN.Doccheck@sgs.com

198 Kazhu Road, Sciencetech Park Guangzhou Economic & Technology Development District, Guangzhou, China 510663

中国·广州·经济技术开发区科学城科珠路198号

邮编: 510663

t (86-20) 82155555

www.sgs.com

t (86-20) 82155555

sgs.china@sgs.com

Test Report

No. CANEC2222380702

Date: 26 Oct 2022

Page 2 of 4

Test Result(s) :

Test Part Description :

Specimen No.	SGS Sample ID	Description
SN1	CAN22-223807.002	Silver-grey plated metal

Remarks :

- (1) 1 mg/kg = 0.0001%
- (2) MDL = Method Detection Limit
- (3) ND = Not Detected (< MDL)
- (4) "-" = Not Regulated

EU RoHS Directive (EU) 2015/863 amending Annex II to Directive 2011/65/EU- Lead, Mercury, Cadmium and Hexavalent chromium

Test Method : With reference to IEC 62321-4:2013+A1:2017, IEC 62321-5:2013, IEC 62321-7-1:2015, analyzed by ICP-OES and UV-Vis .

<u>Test Item(s)</u>	<u>Limit</u>	<u>Unit</u>	<u>MDL</u>	<u>002</u>
Cadmium (Cd)	100	mg/kg	2	ND
Lead (Pb)	1000	mg/kg	2	37
Mercury (Hg)	1000	mg/kg	2	ND
Hexavalent Chromium (Cr(VI))▼	-	µg/cm ²	0.10	ND

Notes :

- (1) The maximum permissible limit is quoted from RoHS Directive (EU) 2015/863.
 - (2) IEC 62321 series is equivalent to EN 62321 series
 - (3) ▼= a. The sample is positive for CrVI if the CrVI concentration is greater than 0.13 µg/cm². The sample coating is considered to contain CrVI
 b. The sample is negative for CrVI if CrVI is ND (concentration less than 0.10 µg/cm²). The coating is considered a non-CrVI based coating
 c. The result between 0.10 µg/cm² and 0.13 µg/cm² is considered to be inconclusive - unavoidable coating variations may influence the determination
- Information on storage conditions and production date of the tested sample is unavailable and thus Cr(VI) results represent status of the sample at the time of testing.

Unless otherwise stated, the decision rule for conformity reporting is based on Binary Statement for Simple Acceptance Rule ($w=0$) stated in ILAC-G8:09/2019.



ATTACHMENTS

Pb/Cd/Hg/Cr⁶⁺ Testing Flow Chart

1) These samples were dissolved totally by pre-conditioning method according to below flow chart. (Cr⁶⁺ test method excluded).

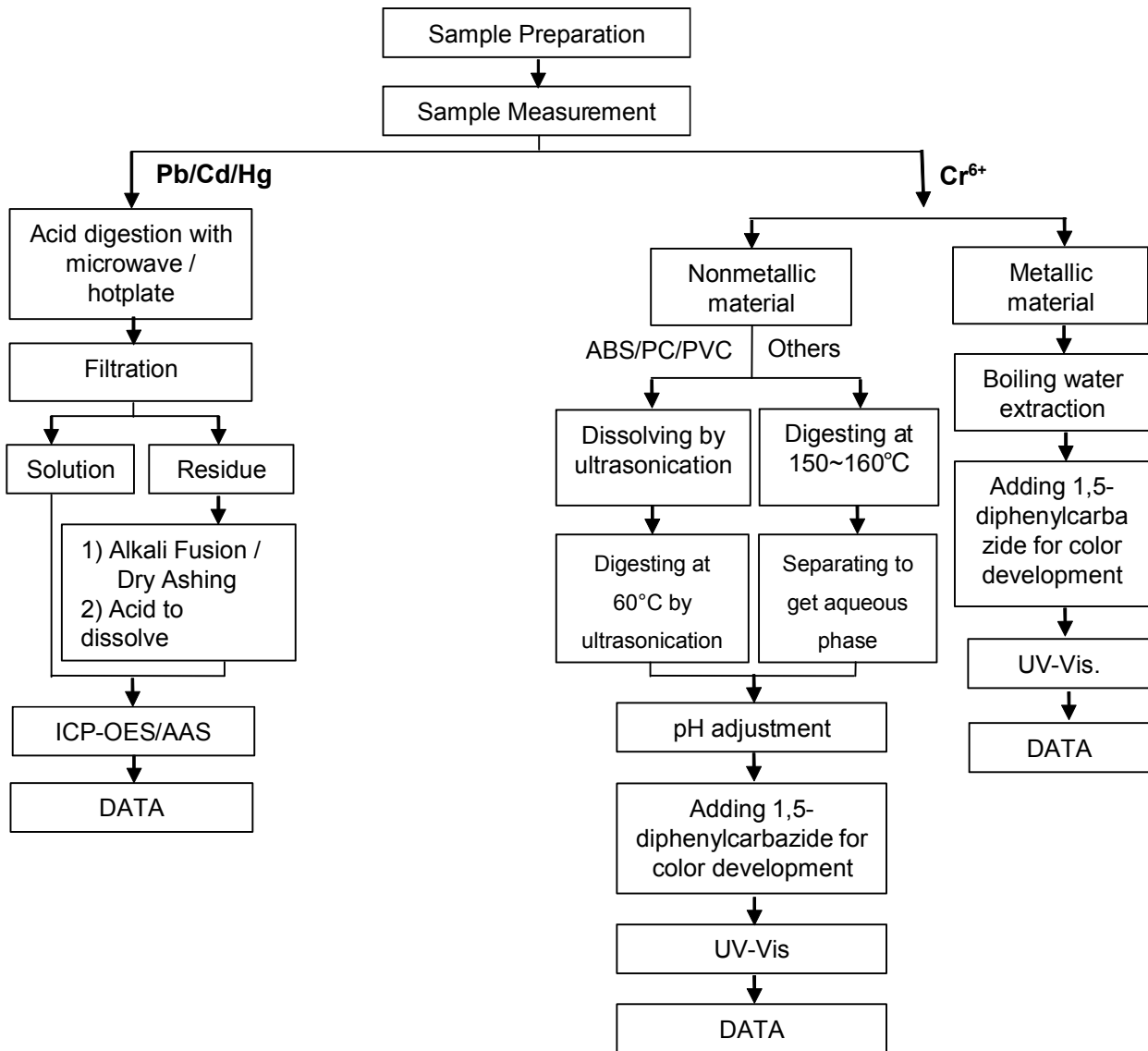

Sample photo:



SGS authenticate the photo on original report only

*** End of Report ***



Test Report

No. CANEC2222380708

Date: 26 Oct 2022

Page 1 of 6

Client Name : SHENZHEN HUALIANWEI ELECTRONICS TECHNOLOGY CO.,LTD

Client Address : 101, 201, PLANT 1, NO.307, GUANLAN GUIHUA ROAD, GUIXIANG COMMUNITY, GUANLAN SUB-DISTRICT, LONGHUA DISTRICT, SHENZHEN CITY, GUANGDONG PROVINCE, CHINA

Sample Name : LCP plastic black color

Model No. : LCP Plastic

Client Ref. Info. : Used for USB series, HDMI series, RJ series, 1394 series, MICRO series, MINI series, DISPLAYPORT series, VGA series, DVI series, TYPE-C series, JACK series

The above sample(s) and information were provided by the client.

SGS Job No. : CP22-057100 - GZ

Date of Sample Received : 20 Oct 2022

Testing Period : 20 Oct 2022 - 26 Oct 2022

Test Requested : Selected test(s) as requested by the client.

Test Method(s) : Please refer to next page(s).

Test Result(s) : Please refer to next page(s).

Result Summary :

Test Requested	Conclusion
EU RoHS Directive (EU) 2015/863 amending Annex II to Directive 2011/65/EU- Lead, Mercury, Cadmium, Hexavalent chromium, Polybrominated biphenyls (PBBs), Polybrominated diphenyl ethers (PBDEs), Bis(2-ethylhexyl) phthalate (DEHP), Butyl benzyl phthalate (BBP), Dibutyl phthalate (DBP) and Diisobutyl phthalate (DIBP)	PASS

Signed for and on behalf of
SGS-CSTC Standards Technical Services Co., Ltd. Guangzhou Branch

Dongyu Xie

Dongyu Xie
Approved Signatory

scan to see the report



689ECF7B



Test Report

No. CANEC2222380708

Date: 26 Oct 2022

Page 2 of 6

Test Result(s) :

Test Part Description :

Specimen No.	SGS Sample ID	Description
SN1	CAN22-223807.008	Black plastic

Remarks :

- (1) 1 mg/kg = 0.0001%
- (2) MDL = Method Detection Limit
- (3) ND = Not Detected (< MDL)
- (4) "-" = Not Regulated

EU RoHS Directive (EU) 2015/863 amending Annex II to Directive 2011/65/EU- Lead, Mercury, Cadmium, Hexavalent chromium, Polybrominated biphenyls (PBBs), Polybrominated diphenyl ethers (PBDEs), Bis(2-ethylhexyl) phthalate (DEHP), Butyl benzyl phthalate (BBP), Dibutyl phthalate (DBP) and Diisobutyl phthalate (DIBP)

Test Method : With reference to IEC 62321-4:2013+A1:2017, IEC 62321-5:2013, IEC 62321-7-2:2017 , IEC 62321-6:2015 and IEC 62321-8:2017, analyzed by ICP-OES , UV-Vis and GC-MS .

<u>Test Item(s)</u>	<u>Limit</u>	<u>Unit</u>	<u>MDL</u>	<u>008</u>
Cadmium (Cd)	100	mg/kg	2	ND
Lead (Pb)	1000	mg/kg	2	6
Mercury (Hg)	1000	mg/kg	2	ND
Hexavalent Chromium (CrVI)	1000	mg/kg	8	ND
Sum of PBBs	1000	mg/kg	-	ND
Monobromobiphenyl	-	mg/kg	5	ND
Dibromobiphenyl	-	mg/kg	5	ND
Tribromobiphenyl	-	mg/kg	5	ND
Tetrabromobiphenyl	-	mg/kg	5	ND
Pentabromobiphenyl	-	mg/kg	5	ND
Hexabromobiphenyl	-	mg/kg	5	ND
Heptabromobiphenyl	-	mg/kg	5	ND
Octabromobiphenyl	-	mg/kg	5	ND
Nonabromobiphenyl	-	mg/kg	5	ND
Decabromobiphenyl	-	mg/kg	5	ND
Sum of PBDEs	1000	mg/kg	-	ND
Monobromodiphenyl ether	-	mg/kg	5	ND
Dibromodiphenyl ether	-	mg/kg	5	ND
Tribromodiphenyl ether	-	mg/kg	5	ND
Tetrabromodiphenyl ether	-	mg/kg	5	ND



Unless otherwise agreed in writing, this document is issued by the Company subject to its General Conditions of Service printed overleaf, available on request or accessible at <http://www.sgs.com/en/Terms-and-Conditions.aspx> and, for electronic format documents, subject to Terms and Conditions for Electronic Documents at <http://www.sgs.com/en/Terms-and-Conditions/Terms-e-Document.aspx>. Attention is drawn to the limitation of liability, indemnification and jurisdiction issues defined therein. Any holder of this document is advised that information contained hereon reflects the Company's findings at the time of its intervention only and within the limits of Client's instructions, if any. The Company's sole responsibility is to its Client and this document does not exonerate parties to a transaction from exercising all their rights and obligations under the transaction documents. This document cannot be reproduced except in full, without prior written approval of the Company. Any unauthorized alteration, forgery or falsification of the content or appearance of this document is unlawful and offenders may be prosecuted to the fullest extent of the law. Unless otherwise stated the results shown in this test report refer only to the sample(s) tested.

Attention: To check the authenticity of testing /inspection report & certificate, please contact us at telephone: (86-755) 8307 1443, or email: CN.Doccheck@sgs.com

Test Report

No. CANEC2222380708

Date: 26 Oct 2022

Page 3 of 6

<u>Test Item(s)</u>	<u>Limit</u>	<u>Unit</u>	<u>MDL</u>	<u>008</u>
Pentabromodiphenyl ether	-	mg/kg	5	ND
Hexabromodiphenyl ether	-	mg/kg	5	ND
Heptabromodiphenyl ether	-	mg/kg	5	ND
Octabromodiphenyl ether	-	mg/kg	5	ND
Nonabromodiphenyl ether	-	mg/kg	5	ND
Decabromodiphenyl ether	-	mg/kg	5	ND
Dibutyl phthalate (DBP)	1000	mg/kg	50	ND
Butyl benzyl phthalate (BBP)	1000	mg/kg	50	ND
Bis (2-ethylhexyl) phthalate (DEHP)	1000	mg/kg	50	ND
Diisobutyl Phthalates (DIBP)	1000	mg/kg	50	ND

Notes :

- (1) The maximum permissible limit is quoted from RoHS Directive (EU) 2015/863.
- (2) IEC 62321 series is equivalent to EN 62321 series
- (3) The restriction of DEHP, BBP, DBP and DIBP shall apply to medical devices, including in vitro medical devices, and monitoring and control instruments, including industrial monitoring and control instruments, from 22 July 2021.

Unless otherwise stated, the decision rule for conformity reporting is based on Binary Statement for Simple Acceptance Rule ($w=0$) stated in ILAC-G8:09/2019.



Unless otherwise agreed in writing, this document is issued by the Company subject to its General Conditions of Service printed overleaf, available on request or accessible at <http://www.sgs.com/en/Terms-and-Conditions.aspx> and, for electronic format documents, subject to Terms and Conditions for Electronic Documents at <http://www.sgs.com/en/Terms-and-Conditions/Terms-e-Documents.aspx>. Attention is drawn to the limitation of liability, indemnification and jurisdiction issues defined therein. Any holder of this document is advised that information contained hereon reflects the Company's findings at the time of its intervention only and within the limits of Client's instructions, if any. The Company's sole responsibility is to its Client and this document does not exonerate parties to a transaction from exercising all their rights and obligations under the transaction documents. This document cannot be reproduced except in full, without prior written approval of the Company. Any unauthorized alteration, forgery or falsification of the content or appearance of this document is unlawful and offenders may be prosecuted to the fullest extent of the law. Unless otherwise stated the results shown in this test report refer only to the sample(s) tested.

Attention: To check the authenticity of testing /inspection report & certificate, please contact us at telephone: (86-755) 8307 1443, or email: CN.Doccheck@sgs.com

ATTACHMENTS

Pb/Cd/Hg/Cr⁶⁺/PBBs/PBDEs Testing Flow Chart

1) These samples were dissolved totally by pre-conditioning method according to below flow chart. (Cr⁶⁺ and PBBs/PBDEs test method excluded).

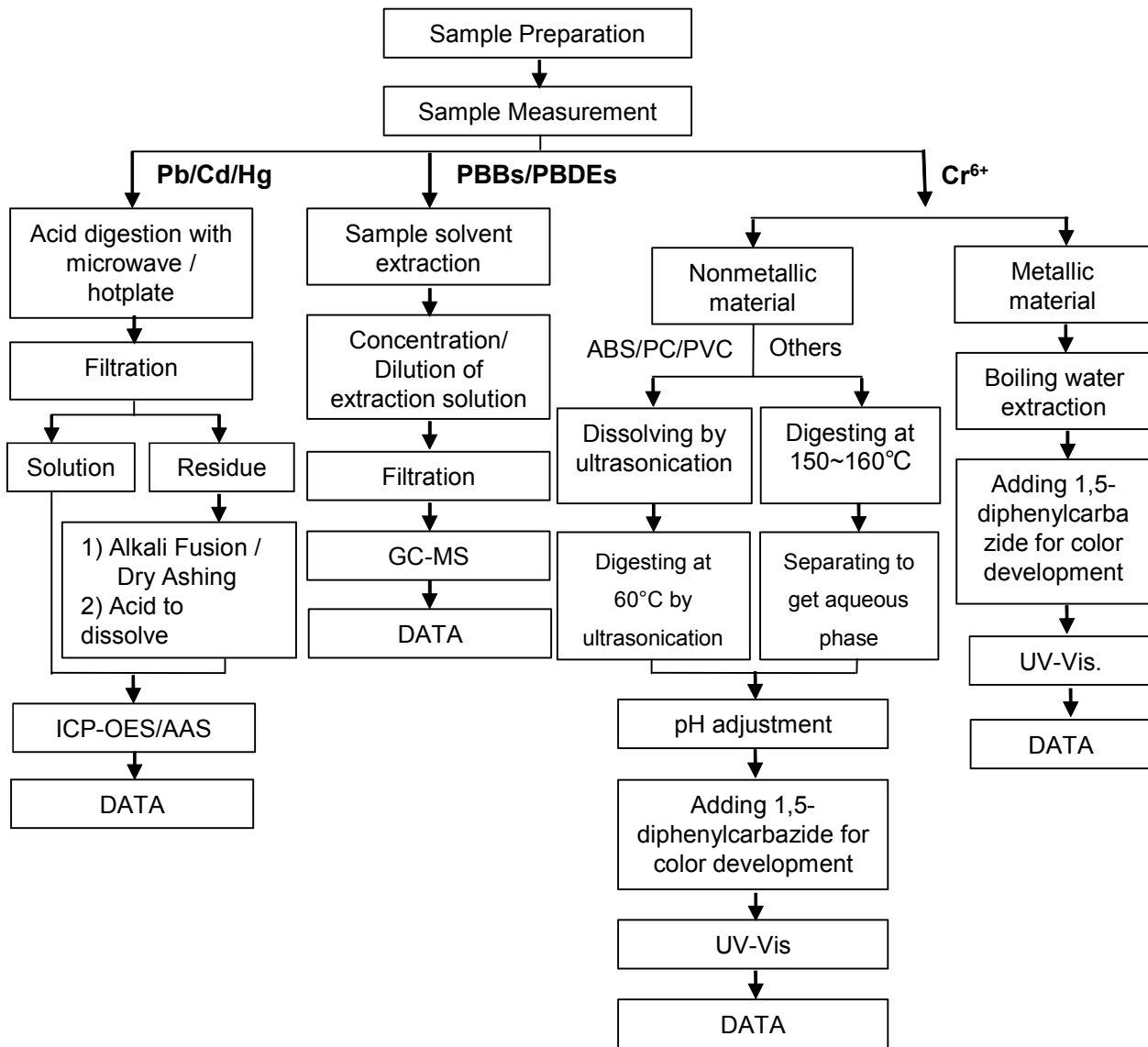

ATTACHMENTS

Phthalates Testing Flow Chart

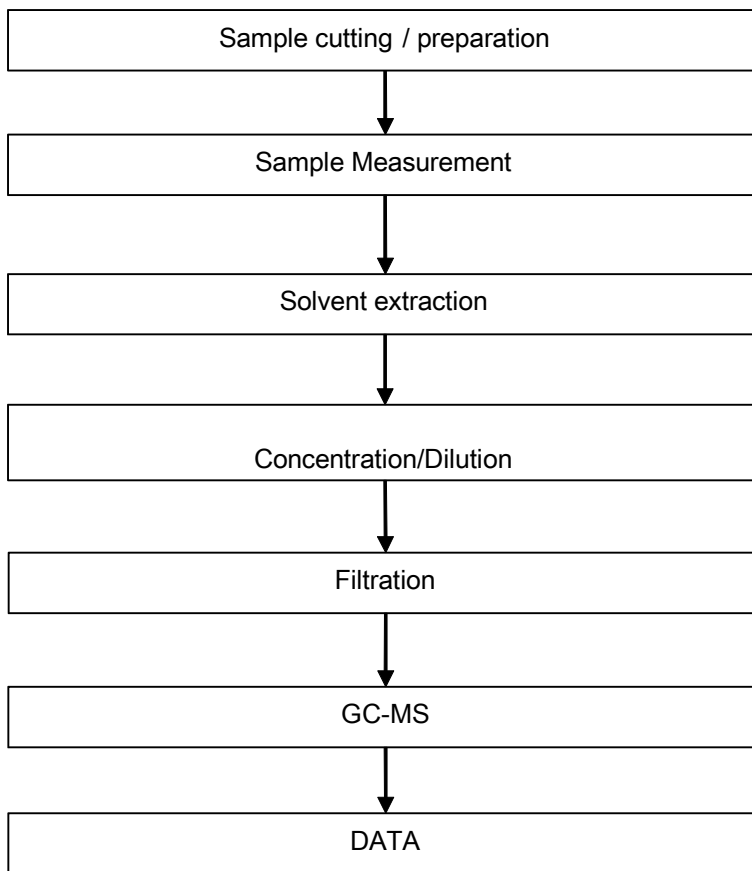

Unless otherwise agreed in writing, this document is issued by the Company subject to its General Conditions of Service printed overleaf, available on request or accessible at <http://www.sgs.com/en/Terms-and-Conditions.aspx> and, for electronic format documents, subject to Terms and Conditions for Electronic Documents at <http://www.sgs.com/en/Terms-and-Conditions/Terms-e-Document.aspx>. Attention is drawn to the limitation of liability, indemnification and jurisdiction issues defined therein. Any holder of this document is advised that information contained hereon reflects the Company's findings at the time of its intervention only and within the limits of Client's instructions, if any. The Company's sole responsibility is to its Client and this document does not exonerate parties to a transaction from exercising all their rights and obligations under the transaction documents. This document cannot be reproduced except in full, without prior written approval of the Company. Any unauthorized alteration, forgery or falsification of the content or appearance of this document is unlawful and offenders may be prosecuted to the fullest extent of the law. Unless otherwise stated the results shown in this test report refer only to the sample(s) tested.

Attention: To check the authenticity of testing / inspection report & certificate, please contact us at telephone: (86-755) 8307 1443, or email: CN_Doccheck@sgs.com

Sample photo:



SGS authenticate the photo on original report only

*** End of Report ***



Test Report

No. CANEC2218227001

Date: 30 Aug 2022

Page 1 of 8

Client Name : SHENZHEN CITY TONGHUA INDUSTRY CO.,LTD

Client Address : TONGHUA MANSIN TONGLE XINBU VILLANG TOWN SHENZHEN CITY CHINA

Sample Name : Nickel(Ni)

The above sample(s) and information were provided by the client.

SGS Job No. : CP22-047169 - SZ
 Date of Sample Received : 25 Aug 2022
 Testing Period : 25 Aug 2022 - 30 Aug 2022
 Test Requested : Selected test(s) as requested by the client.
 Test Method(s) : Please refer to next page(s).
 Test Result(s) : Please refer to next page(s).

Result Summary :

Test Requested	Conclusion
EU RoHS Directive (EU) 2015/863 amending Annex II to Directive 2011/65/EU- Lead, Mercury, Cadmium, Hexavalent chromium, Polybrominated biphenyls (PBBs), Polybrominated diphenyl ethers (PBDEs), Bis(2-ethylhexyl) phthalate (DEHP), Butyl benzyl phthalate (BBP), Dibutyl phthalate (DBP) and Diisobutyl phthalate (DIBP)	PASS
Perfluorooctanoic acid (PFOA) and its salts & Perfluorooctane sulfonates (PFOS) and its derivatives	See Results

Signed for and on behalf of
 SGS-CSTC Standards Technical Services Co., Ltd. Guangzhou Branch

Dongyu Xie

Dongyu Xie
 Approved Signatory

scan to see the report



5753937E



Unless otherwise agreed in writing, this document is issued by the Company subject to its General Conditions of Service printed overleaf, available on request or accessible at <http://www.sgs.com/en/Terms-and-Conditions.aspx> and, for electronic format documents, subject to Terms and Conditions for Electronic Documents at <http://www.sgs.com/en/Terms-and-Conditions/Terms-e-Document.aspx>. Attention is drawn to the limitation of liability, indemnification and jurisdiction issues defined therein. Any holder of this document is advised that information contained hereon reflects the Company's findings at the time of its intervention only and within the limits of Client's instructions, if any. The Company's sole responsibility is to its Client and this document does not exonerate parties to a transaction from exercising all their rights and obligations under the transaction documents. This document cannot be reproduced except in full, without prior written approval of the Company. Any unauthorized alteration, forgery or falsification of the content or appearance of this document is unlawful and offenders may be prosecuted to the fullest extent of the law. Unless otherwise stated the results shown in this test report refer only to the sample(s) tested.

Attention: To check the authenticity of testing /inspection report & certificate, please contact us at telephone: (86-755) 8307 1443, or email: CN.Doccheck@sgs.com

Test Report

No. CANEC2218227001

Date: 30 Aug 2022

Page 2 of 8

Test Result(s) :

Test Part Description :

Specimen No.	SGS Sample ID	Description
SN1	CAN22-182270.001	Silver-gray plated metal

Remarks :

- (1) 1 mg/kg = 0.0001%
- (2) MDL = Method Detection Limit
- (3) ND = Not Detected (< MDL)
- (4) "-" = Not Regulated

EU RoHS Directive (EU) 2015/863 amending Annex II to Directive 2011/65/EU- Lead, Mercury, Cadmium, Hexavalent chromium, Polybrominated biphenyls (PBBs), Polybrominated diphenyl ethers (PBDEs), Bis(2-ethylhexyl) phthalate (DEHP), Butyl benzyl phthalate (BBP), Dibutyl phthalate (DBP) and Diisobutyl phthalate (DIBP)

Test Method : With reference to IEC 62321-4:2013+A1:2017, IEC 62321-5:2013, IEC 62321-7-1:2015 , IEC 62321-6:2015 and IEC 62321-8:2017, analyzed by ICP-OES , UV-Vis and GC-MS .

Test Item(s)	Limit	Unit	MDL	001
Cadmium (Cd)	100	mg/kg	2	ND
Lead (Pb)	1000	mg/kg	2	49
Mercury (Hg)	1000	mg/kg	2	ND
Hexavalent Chromium (Cr(VI))▼	-	µg/cm ²	0.10	ND
Sum of PBBs	1000	mg/kg	-	ND
Monobromobiphenyl	-	mg/kg	5	ND
Dibromobiphenyl	-	mg/kg	5	ND
Tribromobiphenyl	-	mg/kg	5	ND
Tetrabromobiphenyl	-	mg/kg	5	ND
Pentabromobiphenyl	-	mg/kg	5	ND
Hexabromobiphenyl	-	mg/kg	5	ND
Heptabromobiphenyl	-	mg/kg	5	ND
Octabromobiphenyl	-	mg/kg	5	ND
Nonabromobiphenyl	-	mg/kg	5	ND
Decabromobiphenyl	-	mg/kg	5	ND
Sum of PBDEs	1000	mg/kg	-	ND
Monobromodiphenyl ether	-	mg/kg	5	ND
Dibromodiphenyl ether	-	mg/kg	5	ND
Tribromodiphenyl ether	-	mg/kg	5	ND
Tetrabromodiphenyl ether	-	mg/kg	5	ND



Unless otherwise agreed in writing, this document is issued by the Company subject to its General Conditions of Service printed overleaf, available on request or accessible at <http://www.sgs.com/en/Terms-and-Conditions.aspx> and, for electronic format documents, subject to Terms and Conditions for Electronic Documents at <http://www.sgs.com/en/Terms-and-Conditions/Terms-e-Documents.aspx>. Attention is drawn to the limitation of liability, indemnification and jurisdiction issues defined therein. Any holder of this document is advised that information contained hereon reflects the Company's findings at the time of its intervention only and within the limits of Client's instructions, if any. The Company's sole responsibility is to its Client and this document does not exonerate parties to a transaction from exercising all their rights and obligations under the transaction documents. This document cannot be reproduced except in full, without prior written approval of the Company. Any unauthorized alteration, forgery or falsification of the content or appearance of this document is unlawful and offenders may be prosecuted to the fullest extent of the law. Unless otherwise stated the results shown in this test report refer only to the sample(s) tested.

Attention: To check the authenticity of testing /inspection report & certificate, please contact us at telephone: (86-755) 8307 1443, or email: CN.Doccheck@sgs.com

Test Report

No. CANEC2218227001

Date: 30 Aug 2022

Page 3 of 8

<u>Test Item(s)</u>	<u>Limit</u>	<u>Unit</u>	<u>MDL</u>	<u>001</u>
Pentabromodiphenyl ether	-	mg/kg	5	ND
Hexabromodiphenyl ether	-	mg/kg	5	ND
Heptabromodiphenyl ether	-	mg/kg	5	ND
Octabromodiphenyl ether	-	mg/kg	5	ND
Nonabromodiphenyl ether	-	mg/kg	5	ND
Decabromodiphenyl ether	-	mg/kg	5	ND
Dibutyl phthalate (DBP)	1000	mg/kg	50	ND
Butyl benzyl phthalate (BBP)	1000	mg/kg	50	ND
Bis (2-ethylhexyl) phthalate (DEHP)	1000	mg/kg	50	ND
Diisobutyl Phthalates (DIBP)	1000	mg/kg	50	ND

Notes :

- (1) The maximum permissible limit is quoted from RoHS Directive (EU) 2015/863.
- (2) IEC 62321 series is equivalent to EN 62321 series
- (3) ▼= a. The sample is positive for CrVI if the CrVI concentration is greater than 0.13 µg/cm². The sample coating is considered to contain CrVI
 b. The sample is negative for CrVI if CrVI is ND (concentration less than 0.10 µg/cm²). The coating is considered a non-CrVI based coating
 c. The result between 0.10 µg/cm² and 0.13 µg/cm² is considered to be inconclusive - unavoidable coating variations may influence the determination
 Information on storage conditions and production date of the tested sample is unavailable and thus Cr(VI) results represent status of the sample at the time of testing.

Perfluorooctanoic acid (PFOA) and its salts & Perfluorooctane sulfonates (PFOS) and its derivatives

Test Method : With reference to CEN/TS15968:2010, analysis was performed by LC-MS or LC-MS/MS.

<u>Test Item(s)</u>	<u>CAS NO.</u>	<u>Unit</u>	<u>MDL</u>	<u>001</u>
Perfluorooctanoic acid (PFOA) and its salts+	335-67-1	mg/kg	0.010	ND
Perfluorooctane sulfonates (PFOS) ^	1763-23-1	mg/kg	0.010	ND
Perfluorooctane Sulfonamide (PFOSA)	754-91-6	mg/kg	0.010	ND
N-methylperfluoro-1-octanesulfonamide(MeFOSA)	31506-32-8	mg/kg	0.010	ND
N-ethylperfluoro-1-octanesulfonamide (EtFOSA)	4151-50-2	mg/kg	0.010	ND
2-(N-methylperfluoro-1-octanesulfonamido)-ethanol(MeFOSE)	24448-09-7	mg/kg	0.010	ND
2-(N-ethylperfluoro-1-octanesulfonamido)-ethanol(EtFOSE)	1691-99-2	mg/kg	0.010	ND
Perfluorooctane sulfonates (PFOS) and its derivatives	-	mg/kg	-	ND

Notes :



Unless otherwise agreed in writing, this document is issued by the Company subject to its General Conditions of Service printed overleaf, available on request or accessible at <http://www.sgs.com/en/Terms-and-Conditions.aspx> and, for electronic format documents, subject to Terms and Conditions for Electronic Documents at <http://www.sgs.com/en/Terms-and-Conditions/Terms-e-Documents.aspx>. Attention is drawn to the limitation of liability, indemnification and jurisdiction issues defined therein. Any holder of this document is advised that information contained hereon reflects the Company's findings at the time of its intervention only and within the limits of Client's instructions, if any. The Company's sole responsibility is to its Client and this document does not exonerate parties to a transaction from exercising all their rights and obligations under the transaction documents. This document cannot be reproduced except in full, without prior written approval of the Company. Any unauthorized alteration, forgery or falsification of the content or appearance of this document is unlawful and offenders may be prosecuted to the fullest extent of the law. Unless otherwise stated the results shown in this test report refer only to the sample(s) tested.

Attention: To check the authenticity of testing /inspection report & certificate, please contact us at telephone: (86-755) 8307 1443, or email: CN.Doccheck@sgs.com

- (1) + PFOA and its salts including PFOA-Na (CAS No.: 335-95-5), PFOA-K (CAS No.: 2395-00-8), PFOA-Ag (CAS No.: 335-93-3), PFOA-F (CAS No.: 335-66-0) and APFO (CAS No.: 3825-26-1);
- (2) ^ PFOS including PFOS-K (CAS No.: 2795-39-3), PFOS-Li (CAS No.: 29457-72-5), PFOS-NH₄ (CAS No.: 29081-56-9), PFOS-NH(OH)₂ (CAS No.: 70225-14-8), PFOS-N(C₂H₅)₄ (CAS No.: 56773-42-3), PFOS-DDA(CAS No.:251099-16-8) and POSF (CAS No.: 307-35-7)

Unless otherwise stated, the decision rule for conformity reporting is based on Binary Statement for Simple Acceptance Rule ($w=0$) stated in ILAC-G8:09/2019.



Unless otherwise agreed in writing, this document is issued by the Company subject to its General Conditions of Service printed overleaf, available on request or accessible at <http://www.sgs.com/en/Terms-and-Conditions.aspx> and, for electronic format documents, subject to Terms and Conditions for Electronic Documents at <http://www.sgs.com/en/Terms-and-Conditions/Terms-e-Documents.aspx>. Attention is drawn to the limitation of liability, indemnification and jurisdiction issues defined therein. Any holder of this document is advised that information contained hereon reflects the Company's findings at the time of its intervention only and within the limits of Client's instructions, if any. The Company's sole responsibility is to its Client and this document does not exonerate parties to a transaction from exercising all their rights and obligations under the transaction documents. This document cannot be reproduced except in full, without prior written approval of the Company. Any unauthorized alteration, forgery or falsification of the content or appearance of this document is unlawful and offenders may be prosecuted to the fullest extent of the law. Unless otherwise stated the results shown in this test report refer only to the sample(s) tested.

Attention: To check the authenticity of testing / inspection report & certificate, please contact us at telephone: (86-755) 8307 1443, or email: CN.Doccheck@sgs.com

ATTACHMENTS

Pb/Cd/Hg/Cr⁶⁺/PBBs/PBDEs Testing Flow Chart

1) These samples were dissolved totally by pre-conditioning method according to below flow chart. (Cr⁶⁺ and PBBs/PBDEs test method excluded).

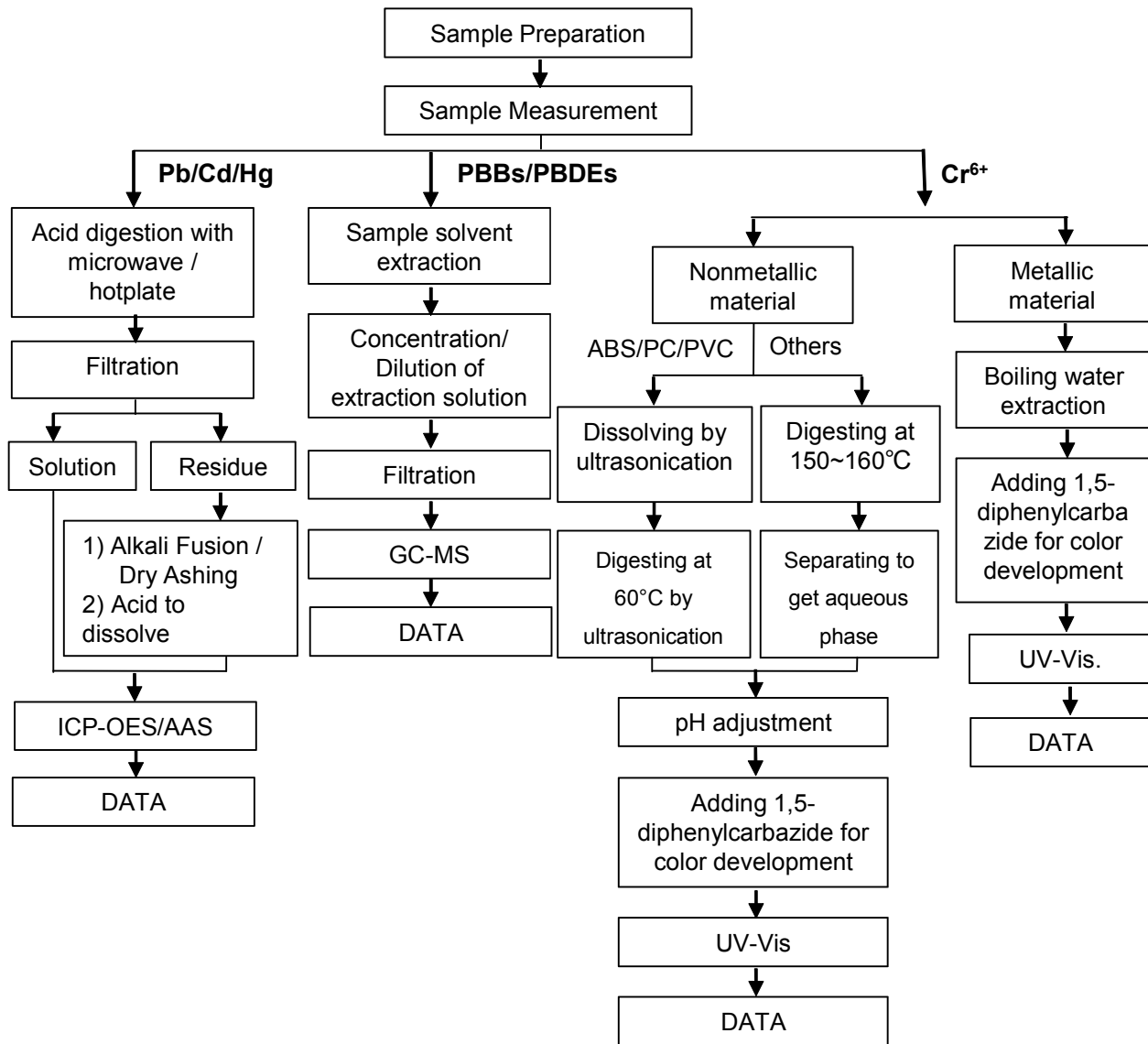

ATTACHMENTS

Phthalates Testing Flow Chart

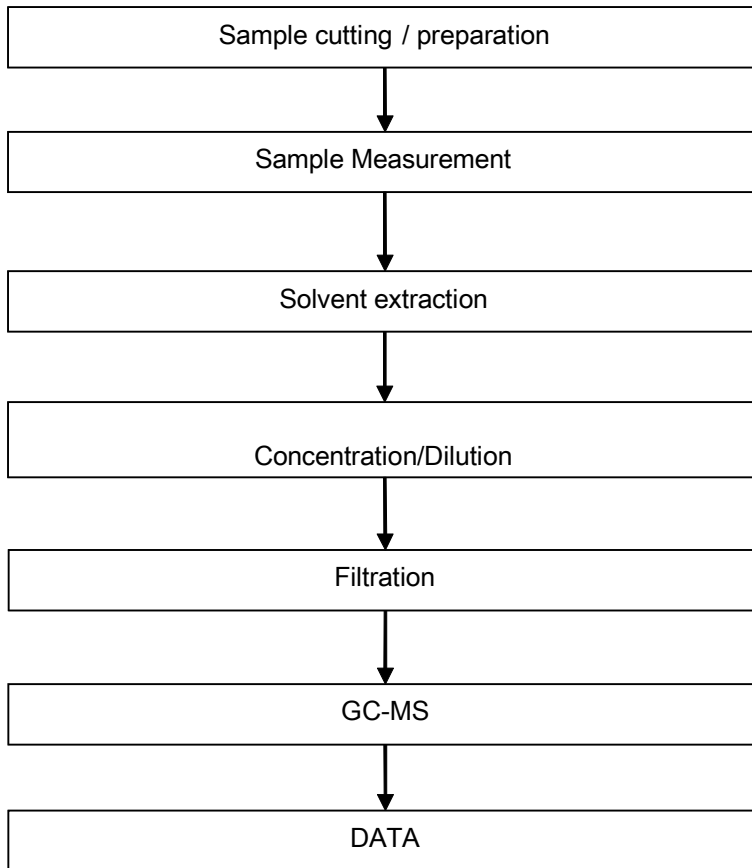

Unless otherwise agreed in writing, this document is issued by the Company subject to its General Conditions of Service printed overleaf, available on request or accessible at <http://www.sgs.com/en/Terms-and-Conditions.aspx> and, for electronic format documents, subject to Terms and Conditions for Electronic Documents at <http://www.sgs.com/en/Terms-and-Conditions/Terms-e-Document.aspx>. Attention is drawn to the limitation of liability, indemnification and jurisdiction issues defined therein. Any holder of this document is advised that information contained hereon reflects the Company's findings at the time of its intervention only and within the limits of Client's instructions, if any. The Company's sole responsibility is to its Client and this document does not exonerate parties to a transaction from exercising all their rights and obligations under the transaction documents. This document cannot be reproduced except in full, without prior written approval of the Company. Any unauthorized alteration, forgery or falsification of the content or appearance of this document is unlawful and offenders may be prosecuted to the fullest extent of the law. Unless otherwise stated the results shown in this test report refer only to the sample(s) tested.

Attention: To check the authenticity of testing / inspection report & certificate, please contact us at telephone: (86-755) 8307 1443, or email: CN.Doccheck@sgs.com

ATTACHMENTS

PFOA / PFOS Testing Flow Chart

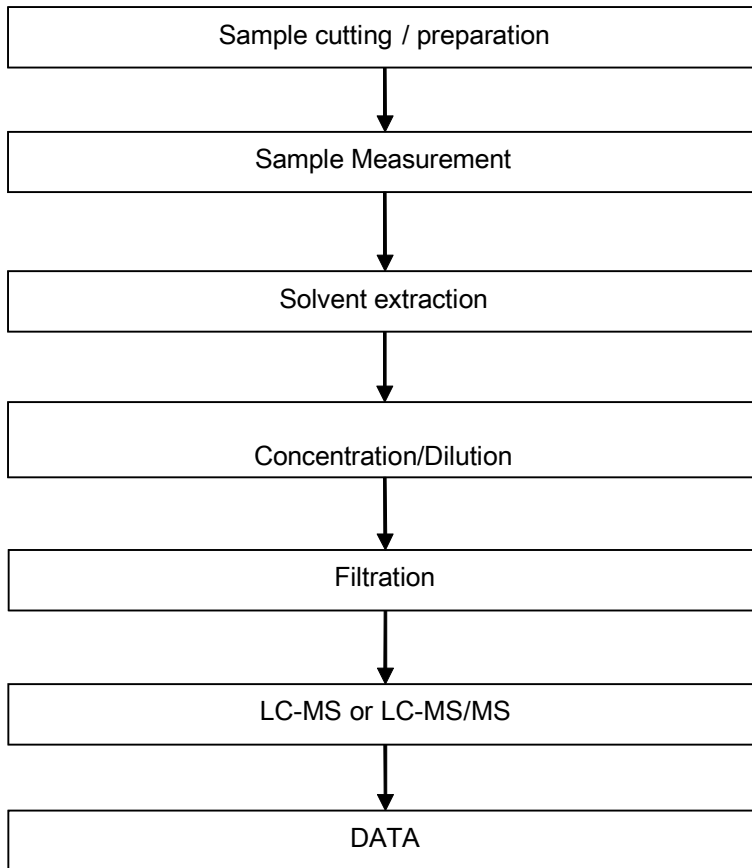

Unless otherwise agreed in writing, this document is issued by the Company subject to its General Conditions of Service printed overleaf, available on request or accessible at <http://www.sgs.com/en/Terms-and-Conditions.aspx> and, for electronic format documents, subject to Terms and Conditions for Electronic Documents at <http://www.sgs.com/en/Terms-and-Conditions/Terms-e-Document.aspx>. Attention is drawn to the limitation of liability, indemnification and jurisdiction issues defined therein. Any holder of this document is advised that information contained hereon reflects the Company's findings at the time of its intervention only and within the limits of Client's instructions, if any. The Company's sole responsibility is to its Client and this document does not exonerate parties to a transaction from exercising all their rights and obligations under the transaction documents. This document cannot be reproduced except in full, without prior written approval of the Company. Any unauthorized alteration, forgery or falsification of the content or appearance of this document is unlawful and offenders may be prosecuted to the fullest extent of the law. Unless otherwise stated the results shown in this test report refer only to the sample(s) tested.

Attention: To check the authenticity of testing / inspection report & certificate, please contact us at telephone: (86-755) 8307 1443, or email: CN.Doccheck@sgs.com

Sample photo:



SGS authenticate the photo on original report only

*** End of Report ***



Test Report

No. CANEC2218227003

Date: 30 Aug 2022

Page 1 of 8

Client Name : SHENZHEN CITY TONGHUA INDUSTRY CO.,LTD

Client Address : TONGHUA MANSIN TONGLE XINBU VILLANG TOWN SHENZHEN CITY CHINA

Sample Name : Bright Tin(SN)

The above sample(s) and information were provided by the client.

SGS Job No. : CP22-047169 - SZ
 Date of Sample Received : 25 Aug 2022
 Testing Period : 25 Aug 2022 - 30 Aug 2022
 Test Requested : Selected test(s) as requested by the client.
 Test Method(s) : Please refer to next page(s).
 Test Result(s) : Please refer to next page(s).

Result Summary :

Test Requested	Conclusion
EU RoHS Directive (EU) 2015/863 amending Annex II to Directive 2011/65/EU- Lead, Mercury, Cadmium, Hexavalent chromium, Polybrominated biphenyls (PBBs), Polybrominated diphenyl ethers (PBDEs), Bis(2-ethylhexyl) phthalate (DEHP), Butyl benzyl phthalate (BBP), Dibutyl phthalate (DBP) and Diisobutyl phthalate (DIBP)	PASS
Perfluorooctanoic acid (PFOA) and its salts & Perfluorooctane sulfonates (PFOS) and its derivatives	See Results

Signed for and on behalf of
 SGS-CSTC Standards Technical Services Co., Ltd. Guangzhou Branch

Dongyu Xie

Dongyu Xie
 Approved Signatory

scan to see the report



87F8007D



Test Report

No. CANEC2218227003

Date: 30 Aug 2022

Page 2 of 8

Test Result(s) :

Test Part Description :

Specimen No.	SGS Sample ID	Description
SN1	CAN22-182270.003	Silver-gray plated metal

Remarks :

- (1) 1 mg/kg = 0.0001%
- (2) MDL = Method Detection Limit
- (3) ND = Not Detected (< MDL)
- (4) "-" = Not Regulated

EU RoHS Directive (EU) 2015/863 amending Annex II to Directive 2011/65/EU- Lead, Mercury, Cadmium, Hexavalent chromium, Polybrominated biphenyls (PBBs), Polybrominated diphenyl ethers (PBDEs), Bis(2-ethylhexyl) phthalate (DEHP), Butyl benzyl phthalate (BBP), Dibutyl phthalate (DBP) and Diisobutyl phthalate (DIBP)

Test Method : With reference to IEC 62321-4:2013+A1:2017, IEC 62321-5:2013, IEC 62321-7-1:2015 , IEC 62321-6:2015 and IEC 62321-8:2017, analyzed by ICP-OES , UV-Vis and GC-MS .

Test Item(s)	Limit	Unit	MDL	003
Cadmium (Cd)	100	mg/kg	2	ND
Lead (Pb)	1000	mg/kg	2	44
Mercury (Hg)	1000	mg/kg	2	ND
Hexavalent Chromium (Cr(VI))▼	-	µg/cm ²	0.10	ND
Sum of PBBs	1000	mg/kg	-	ND
Monobromobiphenyl	-	mg/kg	5	ND
Dibromobiphenyl	-	mg/kg	5	ND
Tribromobiphenyl	-	mg/kg	5	ND
Tetrabromobiphenyl	-	mg/kg	5	ND
Pentabromobiphenyl	-	mg/kg	5	ND
Hexabromobiphenyl	-	mg/kg	5	ND
Heptabromobiphenyl	-	mg/kg	5	ND
Octabromobiphenyl	-	mg/kg	5	ND
Nonabromobiphenyl	-	mg/kg	5	ND
Decabromobiphenyl	-	mg/kg	5	ND
Sum of PBDEs	1000	mg/kg	-	ND
Monobromodiphenyl ether	-	mg/kg	5	ND
Dibromodiphenyl ether	-	mg/kg	5	ND
Tribromodiphenyl ether	-	mg/kg	5	ND
Tetrabromodiphenyl ether	-	mg/kg	5	ND



Unless otherwise agreed in writing, this document is issued by the Company subject to its General Conditions of Service printed overleaf, available on request or accessible at <http://www.sgs.com/en/Terms-and-Conditions.aspx> and, for electronic format documents, subject to Terms and Conditions for Electronic Documents at <http://www.sgs.com/en/Terms-and-Conditions/Terms-e-Documents.aspx>. Attention is drawn to the limitation of liability, indemnification and jurisdiction issues defined therein. Any holder of this document is advised that information contained hereon reflects the Company's findings at the time of its intervention only and within the limits of Client's instructions, if any. The Company's sole responsibility is to its Client and this document does not exonerate parties to a transaction from exercising all their rights and obligations under the transaction documents. This document cannot be reproduced except in full, without prior written approval of the Company. Any unauthorized alteration, forgery or falsification of the content or appearance of this document is unlawful and offenders may be prosecuted to the fullest extent of the law. Unless otherwise stated the results shown in this test report refer only to the sample(s) tested.

Attention: To check the authenticity of testing /inspection report & certificate, please contact us at telephone: (86-755) 8307 1443, or email: CN.Doccheck@sgs.com

Test Report

No. CANEC2218227003

Date: 30 Aug 2022

Page 3 of 8

<u>Test Item(s)</u>	<u>Limit</u>	<u>Unit</u>	<u>MDL</u>	<u>003</u>
Pentabromodiphenyl ether	-	mg/kg	5	ND
Hexabromodiphenyl ether	-	mg/kg	5	ND
Heptabromodiphenyl ether	-	mg/kg	5	ND
Octabromodiphenyl ether	-	mg/kg	5	ND
Nonabromodiphenyl ether	-	mg/kg	5	ND
Decabromodiphenyl ether	-	mg/kg	5	ND
Dibutyl phthalate (DBP)	1000	mg/kg	50	ND
Butyl benzyl phthalate (BBP)	1000	mg/kg	50	ND
Bis (2-ethylhexyl) phthalate (DEHP)	1000	mg/kg	50	ND
Diisobutyl Phthalates (DIBP)	1000	mg/kg	50	ND

Notes :

- (1) The maximum permissible limit is quoted from RoHS Directive (EU) 2015/863.
- (2) IEC 62321 series is equivalent to EN 62321 series
- (3) ▼= a. The sample is positive for CrVI if the CrVI concentration is greater than 0.13 $\mu\text{g}/\text{cm}^2$. The sample coating is considered to contain CrVI
 b. The sample is negative for CrVI if CrVI is ND (concentration less than 0.10 $\mu\text{g}/\text{cm}^2$). The coating is considered a non-CrVI based coating
 c. The result between 0.10 $\mu\text{g}/\text{cm}^2$ and 0.13 $\mu\text{g}/\text{cm}^2$ is considered to be inconclusive - unavoidable coating variations may influence the determination
 Information on storage conditions and production date of the tested sample is unavailable and thus Cr(VI) results represent status of the sample at the time of testing.

Perfluorooctanoic acid (PFOA) and its salts & Perfluorooctane sulfonates (PFOS) and its derivatives

Test Method : With reference to CEN/TS15968:2010, analysis was performed by LC-MS or LC-MS/MS.

<u>Test Item(s)</u>	<u>CAS NO.</u>	<u>Unit</u>	<u>MDL</u>	<u>003</u>
Perfluorooctanoic acid (PFOA) and its salts+	335-67-1	mg/kg	0.010	ND
Perfluorooctane sulfonates (PFOS) ^	1763-23-1	mg/kg	0.010	ND
Perfluorooctane Sulfonamide (PFOSA)	754-91-6	mg/kg	0.010	ND
N-methylperfluoro-1-octanesulfonamide(MeFOSA)	31506-32-8	mg/kg	0.010	ND
N-ethylperfluoro-1-octanesulfonamide (EtFOSA)	4151-50-2	mg/kg	0.010	ND
2-(N-methylperfluoro-1-octanesulfonamido)-ethanol(MeFOSE)	24448-09-7	mg/kg	0.010	ND
2-(N-ethylperfluoro-1-octanesulfonamido)-ethanol(EtFOSE)	1691-99-2	mg/kg	0.010	ND
Perfluorooctane sulfonates (PFOS) and its derivatives	-	mg/kg	-	ND

Notes :



Unless otherwise agreed in writing, this document is issued by the Company subject to its General Conditions of Service printed overleaf, available on request or accessible at <http://www.sgs.com/en/Terms-and-Conditions.aspx> and, for electronic format documents, subject to Terms and Conditions for Electronic Documents at <http://www.sgs.com/en/Terms-and-Conditions/Terms-e-Document.aspx>. Attention is drawn to the limitation of liability, indemnification and jurisdiction issues defined therein. Any holder of this document is advised that information contained hereon reflects the Company's findings at the time of its intervention only and within the limits of Client's instructions, if any. The Company's sole responsibility is to its Client and this document does not exonerate parties to a transaction from exercising all their rights and obligations under the transaction documents. This document cannot be reproduced except in full, without prior written approval of the Company. Any unauthorized alteration, forgery or falsification of the content or appearance of this document is unlawful and offenders may be prosecuted to the fullest extent of the law. Unless otherwise stated the results shown in this test report refer only to the sample(s) tested.

Attention: To check the authenticity of testing /inspection report & certificate, please contact us at telephone: (86-755) 8307 1443, or email: CN.Doccheck@sgs.com

- (1) + PFOA and its salts including PFOA-Na (CAS No.: 335-95-5), PFOA-K (CAS No.: 2395-00-8), PFOA-Ag (CAS No.: 335-93-3), PFOA-F (CAS No.: 335-66-0) and APFO (CAS No.: 3825-26-1);
 (2) ^ PFOS including PFOS-K (CAS No.: 2795-39-3), PFOS-Li (CAS No.: 29457-72-5), PFOS-NH₄ (CAS No.: 29081-56-9), PFOS-NH(OH)₂ (CAS No.: 70225-14-8), PFOS-N(C₂H₅)₄ (CAS No.: 56773-42-3), PFOS-DDA (CAS No.: 251099-16-8) and POSF (CAS No.: 307-35-7)

Unless otherwise stated, the decision rule for conformity reporting is based on Binary Statement for Simple Acceptance Rule ($w=0$) stated in ILAC-G8:09/2019.



Unless otherwise agreed in writing, this document is issued by the Company subject to its General Conditions of Service printed overleaf, available on request or accessible at <http://www.sgs.com/en/Terms-and-Conditions.aspx> and, for electronic format documents, subject to Terms and Conditions for Electronic Documents at <http://www.sgs.com/en/Terms-and-Conditions/Terms-e-Document.aspx>. Attention is drawn to the limitation of liability, indemnification and jurisdiction issues defined therein. Any holder of this document is advised that information contained hereon reflects the Company's findings at the time of its intervention only and within the limits of Client's instructions, if any. The Company's sole responsibility is to its Client and this document does not exonerate parties to a transaction from exercising all their rights and obligations under the transaction documents. This document cannot be reproduced except in full, without prior written approval of the Company. Any unauthorized alteration, forgery or falsification of the content or appearance of this document is unlawful and offenders may be prosecuted to the fullest extent of the law. Unless otherwise stated the results shown in this test report refer only to the sample(s) tested.

Attention: To check the authenticity of testing / inspection report & certificate, please contact us at telephone: (86-755) 8307 1443, or email: CN.Doccheck@sgs.com

ATTACHMENTS

Pb/Cd/Hg/Cr⁶⁺/PBBs/PBDEs Testing Flow Chart

1) These samples were dissolved totally by pre-conditioning method according to below flow chart. (Cr⁶⁺ and PBBs/PBDEs test method excluded).

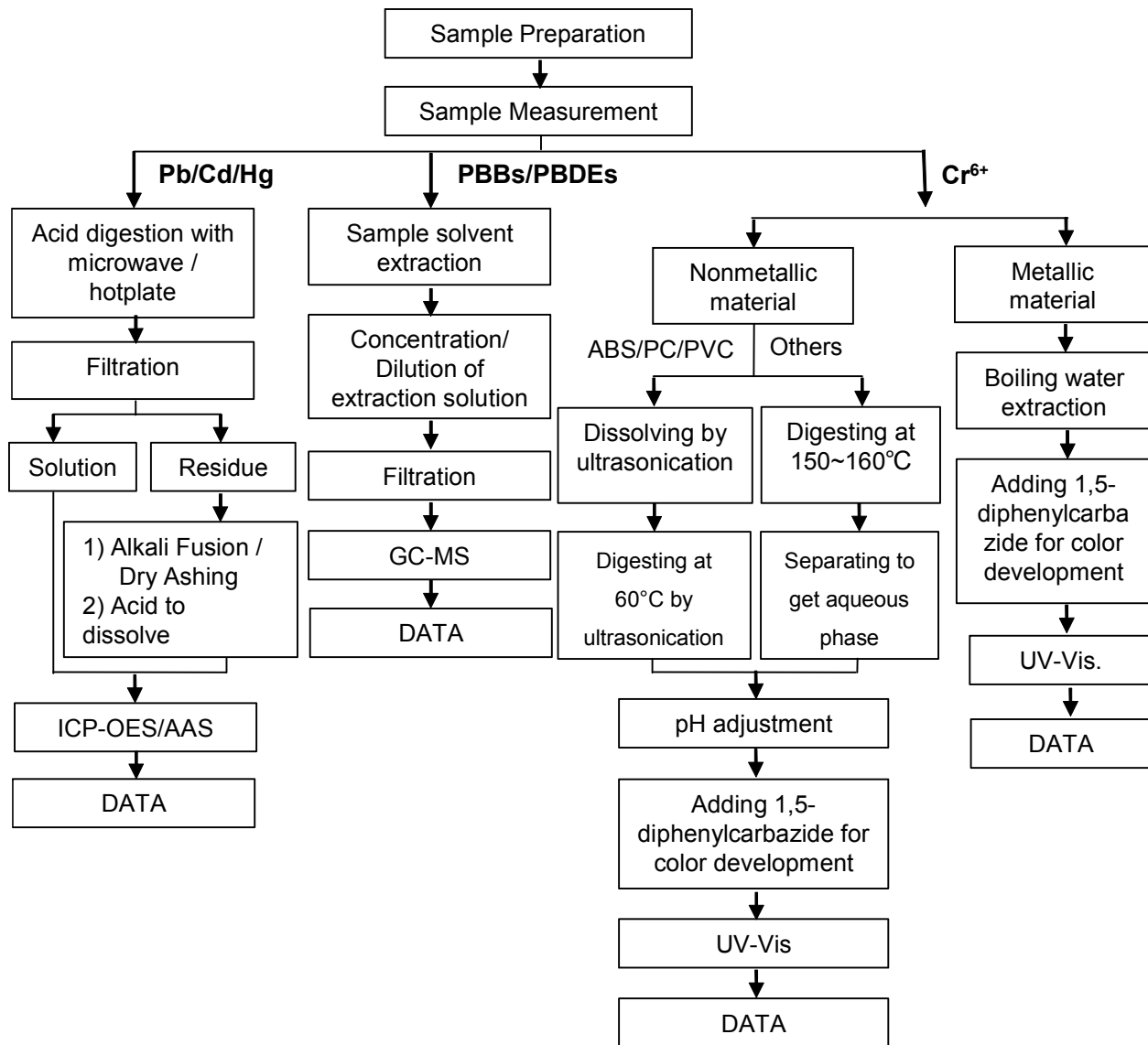

ATTACHMENTS

Phthalates Testing Flow Chart

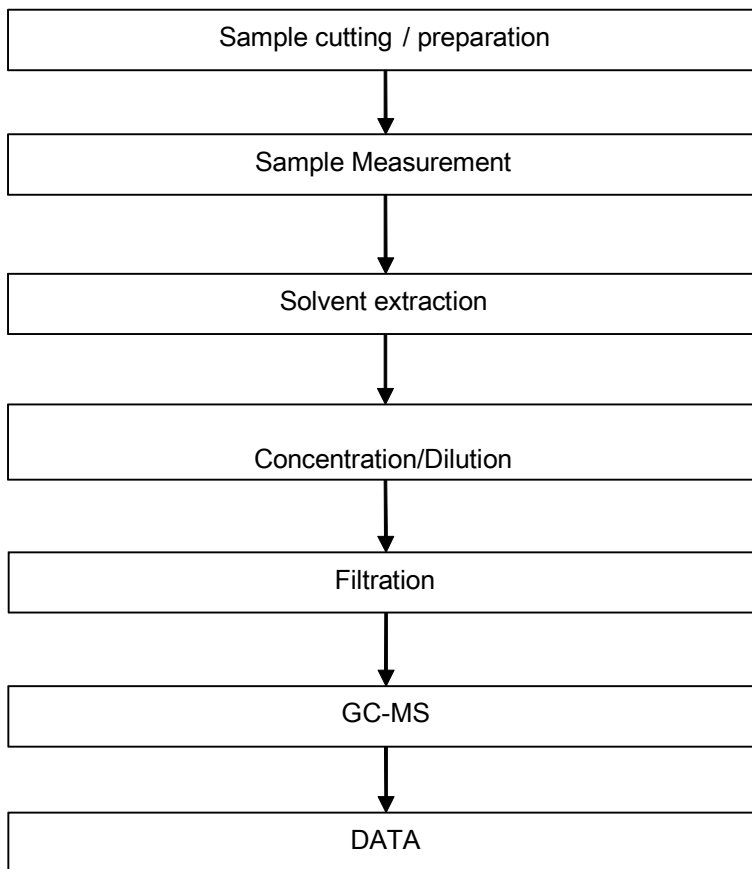

Unless otherwise agreed in writing, this document is issued by the Company subject to its General Conditions of Service printed overleaf, available on request or accessible at <http://www.sgs.com/en/Terms-and-Conditions.aspx> and, for electronic format documents, subject to Terms and Conditions for Electronic Documents at <http://www.sgs.com/en/Terms-and-Conditions/Terms-e-Document.aspx>. Attention is drawn to the limitation of liability, indemnification and jurisdiction issues defined therein. Any holder of this document is advised that information contained hereon reflects the Company's findings at the time of its intervention only and within the limits of Client's instructions, if any. The Company's sole responsibility is to its Client and this document does not exonerate parties to a transaction from exercising all their rights and obligations under the transaction documents. This document cannot be reproduced except in full, without prior written approval of the Company. Any unauthorized alteration, forgery or falsification of the content or appearance of this document is unlawful and offenders may be prosecuted to the fullest extent of the law. Unless otherwise stated the results shown in this test report refer only to the sample(s) tested.

Attention: To check the authenticity of testing / inspection report & certificate, please contact us at telephone: (86-755) 8307 1443, or email: CN_Doccheck@sgs.com

ATTACHMENTS

PFOA / PFOS Testing Flow Chart

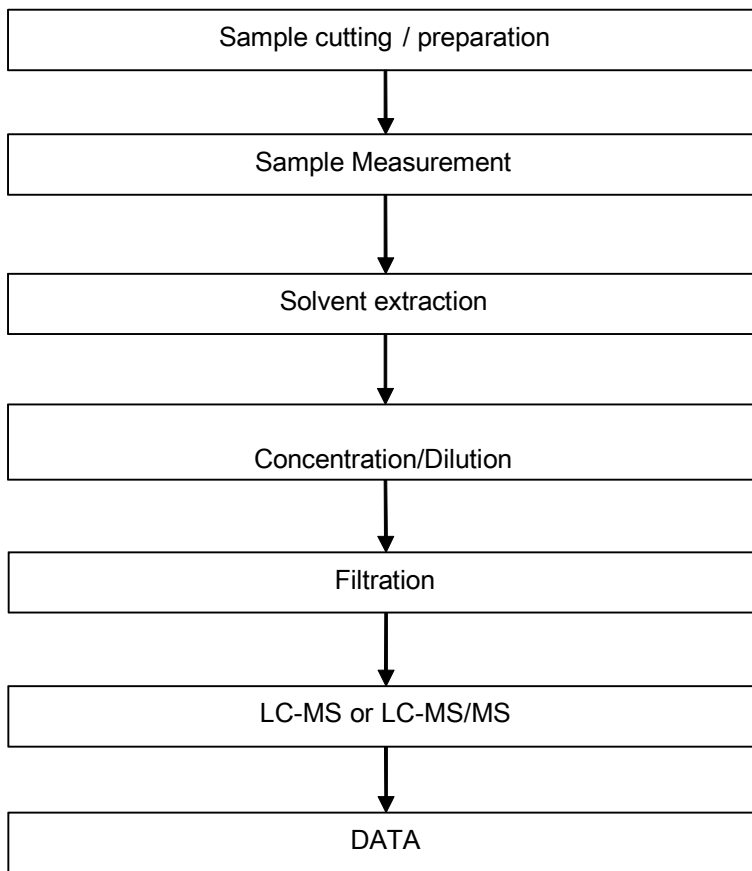

Unless otherwise agreed in writing, this document is issued by the Company subject to its General Conditions of Service printed overleaf, available on request or accessible at <http://www.sgs.com/en/Terms-and-Conditions.aspx> and, for electronic format documents, subject to Terms and Conditions for Electronic Documents at <http://www.sgs.com/en/Terms-and-Conditions/Terms-e-Document.aspx>. Attention is drawn to the limitation of liability, indemnification and jurisdiction issues defined therein. Any holder of this document is advised that information contained hereon reflects the Company's findings at the time of its intervention only and within the limits of Client's instructions, if any. The Company's sole responsibility is to its Client and this document does not exonerate parties to a transaction from exercising all their rights and obligations under the transaction documents. This document cannot be reproduced except in full, without prior written approval of the Company. Any unauthorized alteration, forgery or falsification of the content or appearance of this document is unlawful and offenders may be prosecuted to the fullest extent of the law. Unless otherwise stated the results shown in this test report refer only to the sample(s) tested.

Attention: To check the authenticity of testing / inspection report & certificate, please contact us at telephone: (86-755) 8307 1443, or email: CN.Doccheck@sgs.com

Sample photo:



SGS authenticate the photo on original report only

*** End of Report ***



Test Report

No. CANEC2218227002

Date: 30 Aug 2022

Page 1 of 8

Client Name : SHENZHEN CITY TONGHUA INDUSTRY CO.,LTD

Client Address : TONGHUA MANSIN TONGLE XINBU VILLANG TOWN SHENZHEN CITY CHINA

Sample Name : Gold (AU)

The above sample(s) and information were provided by the client.

SGS Job No. : CP22-047169 - SZ
 Date of Sample Received : 25 Aug 2022
 Testing Period : 25 Aug 2022 - 30 Aug 2022
 Test Requested : Selected test(s) as requested by the client.
 Test Method(s) : Please refer to next page(s).
 Test Result(s) : Please refer to next page(s).

Result Summary :

Test Requested	Conclusion
EU RoHS Directive (EU) 2015/863 amending Annex II to Directive 2011/65/EU- Lead, Mercury, Cadmium, Hexavalent chromium, Polybrominated biphenyls (PBBs), Polybrominated diphenyl ethers (PBDEs), Bis(2-ethylhexyl) phthalate (DEHP), Butyl benzyl phthalate (BBP), Dibutyl phthalate (DBP) and Diisobutyl phthalate (DIBP)	PASS
Perfluorooctanoic acid (PFOA) and its salts & Perfluorooctane sulfonates (PFOS) and its derivatives	See Results

Signed for and on behalf of
 SGS-CSTC Standards Technical Services Co., Ltd. Guangzhou Branch

Dongyu Xie

Dongyu Xie
 Approved Signatory

scan to see the report



9B230D54



Unless otherwise agreed in writing, this document is issued by the Company subject to its General Conditions of Service printed overleaf, available on request or accessible at <http://www.sgs.com/en/Terms-and-Conditions.aspx> and, for electronic format documents, subject to Terms and Conditions for Electronic Documents at <http://www.sgs.com/en/Terms-and-Conditions/Terms-e-Documents.aspx>. Attention is drawn to the limitation of liability, indemnification and jurisdiction issues defined therein. Any holder of this document is advised that information contained hereon reflects the Company's findings at the time of its intervention only and within the limits of Client's instructions, if any. The Company's sole responsibility is to its Client and this document does not exonerate parties to a transaction from exercising all their rights and obligations under the transaction documents. This document cannot be reproduced except in full, without prior written approval of the Company. Any unauthorized alteration, forgery or falsification of the content or appearance of this document is unlawful and offenders may be prosecuted to the fullest extent of the law. Unless otherwise stated the results shown in this test report refer only to the sample(s) tested.

Attention: To check the authenticity of testing /inspection report & certificate, please contact us at telephone: (86-755) 8307 1443, or email: CN.Doccheck@sgs.com

Test Report

No. CANEC2218227002

Date: 30 Aug 2022

Page 2 of 8

Test Result(s) :

Test Part Description :

Specimen No.	SGS Sample ID	Description
SN1	CAN22-182270.002	Gold plated metal

Remarks :

- (1) 1 mg/kg = 0.0001%
- (2) MDL = Method Detection Limit
- (3) ND = Not Detected (< MDL)
- (4) "-" = Not Regulated

EU RoHS Directive (EU) 2015/863 amending Annex II to Directive 2011/65/EU- Lead, Mercury, Cadmium, Hexavalent chromium, Polybrominated biphenyls (PBBs), Polybrominated diphenyl ethers (PBDEs), Bis(2-ethylhexyl) phthalate (DEHP), Butyl benzyl phthalate (BBP), Dibutyl phthalate (DBP) and Diisobutyl phthalate (DIBP)

Test Method : With reference to IEC 62321-4:2013+A1:2017, IEC 62321-5:2013, IEC 62321-7-1:2015 , IEC 62321-6:2015 and IEC 62321-8:2017, analyzed by ICP-OES , UV-Vis and GC-MS .

Test Item(s)	Limit	Unit	MDL	002
Cadmium (Cd)	100	mg/kg	2	ND
Lead (Pb)	1000	mg/kg	2	50
Mercury (Hg)	1000	mg/kg	2	ND
Hexavalent Chromium (Cr(VI))▼	-	µg/cm ²	0.10	ND
Sum of PBBs	1000	mg/kg	-	ND
Monobromobiphenyl	-	mg/kg	5	ND
Dibromobiphenyl	-	mg/kg	5	ND
Tribromobiphenyl	-	mg/kg	5	ND
Tetrabromobiphenyl	-	mg/kg	5	ND
Pentabromobiphenyl	-	mg/kg	5	ND
Hexabromobiphenyl	-	mg/kg	5	ND
Heptabromobiphenyl	-	mg/kg	5	ND
Octabromobiphenyl	-	mg/kg	5	ND
Nonabromobiphenyl	-	mg/kg	5	ND
Decabromobiphenyl	-	mg/kg	5	ND
Sum of PBDEs	1000	mg/kg	-	ND
Monobromodiphenyl ether	-	mg/kg	5	ND
Dibromodiphenyl ether	-	mg/kg	5	ND
Tribromodiphenyl ether	-	mg/kg	5	ND
Tetrabromodiphenyl ether	-	mg/kg	5	ND



Unless otherwise agreed in writing, this document is issued by the Company subject to its General Conditions of Service printed overleaf, available on request or accessible at <http://www.sgs.com/en/Terms-and-Conditions.aspx> and, for electronic format documents, subject to Terms and Conditions for Electronic Documents at <http://www.sgs.com/en/Terms-and-Conditions/Terms-e-Documents.aspx>. Attention is drawn to the limitation of liability, indemnification and jurisdiction issues defined therein. Any holder of this document is advised that information contained hereon reflects the Company's findings at the time of its intervention only and within the limits of Client's instructions, if any. The Company's sole responsibility is to its Client and this document does not exonerate parties to a transaction from exercising all their rights and obligations under the transaction documents. This document cannot be reproduced except in full, without prior written approval of the Company. Any unauthorized alteration, forgery or falsification of the content or appearance of this document is unlawful and offenders may be prosecuted to the fullest extent of the law. Unless otherwise stated the results shown in this test report refer only to the sample(s) tested.

Attention: To check the authenticity of testing / inspection report & certificate, please contact us at telephone: (86-755) 8307 1443, or email: CN.Doccheck@sgs.com

Test Report

No. CANEC2218227002

Date: 30 Aug 2022

Page 3 of 8

<u>Test Item(s)</u>	<u>Limit</u>	<u>Unit</u>	<u>MDL</u>	<u>002</u>
Pentabromodiphenyl ether	-	mg/kg	5	ND
Hexabromodiphenyl ether	-	mg/kg	5	ND
Heptabromodiphenyl ether	-	mg/kg	5	ND
Octabromodiphenyl ether	-	mg/kg	5	ND
Nonabromodiphenyl ether	-	mg/kg	5	ND
Decabromodiphenyl ether	-	mg/kg	5	ND
Dibutyl phthalate (DBP)	1000	mg/kg	50	ND
Butyl benzyl phthalate (BBP)	1000	mg/kg	50	ND
Bis (2-ethylhexyl) phthalate (DEHP)	1000	mg/kg	50	ND
Diisobutyl Phthalates (DIBP)	1000	mg/kg	50	ND

Notes :

- (1) The maximum permissible limit is quoted from RoHS Directive (EU) 2015/863.
- (2) IEC 62321 series is equivalent to EN 62321 series
- (3) ▼= a. The sample is positive for CrVI if the CrVI concentration is greater than 0.13 µg/cm². The sample coating is considered to contain CrVI
 b. The sample is negative for CrVI if CrVI is ND (concentration less than 0.10 µg/cm²). The coating is considered a non-CrVI based coating
 c. The result between 0.10 µg/cm² and 0.13 µg/cm² is considered to be inconclusive - unavoidable coating variations may influence the determination
 Information on storage conditions and production date of the tested sample is unavailable and thus Cr(VI) results represent status of the sample at the time of testing.

Perfluorooctanoic acid (PFOA) and its salts & Perfluorooctane sulfonates (PFOS) and its derivatives

Test Method : With reference to CEN/TS15968:2010, analysis was performed by LC-MS or LC-MS/MS.

<u>Test Item(s)</u>	<u>CAS NO.</u>	<u>Unit</u>	<u>MDL</u>	<u>002</u>
Perfluorooctanoic acid (PFOA) and its salts+	335-67-1	mg/kg	0.010	ND
Perfluorooctane sulfonates (PFOS) ^	1763-23-1	mg/kg	0.010	ND
Perfluorooctane Sulfonamide (PFOSA)	754-91-6	mg/kg	0.010	ND
N-methylperfluoro-1-octanesulfonamide(MeFOSA)	31506-32-8	mg/kg	0.010	ND
N-ethylperfluoro-1-octanesulfonamide (EtFOSA)	4151-50-2	mg/kg	0.010	ND
2-(N-methylperfluoro-1-octanesulfonamido)-ethanol(MeFOSE)	24448-09-7	mg/kg	0.010	ND
2-(N-ethylperfluoro-1-octanesulfonamido)-ethanol(EtFOSE)	1691-99-2	mg/kg	0.010	ND
Perfluorooctane sulfonates (PFOS) and its derivatives	-	mg/kg	-	ND

Notes :



Unless otherwise agreed in writing, this document is issued by the Company subject to its General Conditions of Service printed overleaf, available on request or accessible at <http://www.sgs.com/en/Terms-and-Conditions.aspx> and, for electronic format documents, subject to Terms and Conditions for Electronic Documents at <http://www.sgs.com/en/Terms-and-Conditions/Terms-e-Document.aspx>. Attention is drawn to the limitation of liability, indemnification and jurisdiction issues defined therein. Any holder of this document is advised that information contained hereon reflects the Company's findings at the time of its intervention only and within the limits of Client's instructions, if any. The Company's sole responsibility is to its Client and this document does not exonerate parties to a transaction from exercising all their rights and obligations under the transaction documents. This document cannot be reproduced except in full, without prior written approval of the Company. Any unauthorized alteration, forgery or falsification of the content or appearance of this document is unlawful and offenders may be prosecuted to the fullest extent of the law. Unless otherwise stated the results shown in this test report refer only to the sample(s) tested.

Attention: To check the authenticity of testing /inspection report & certificate, please contact us at telephone: (86-755) 8307 1443, or email: CN.Doccheck@sgs.com

- (1) + PFOA and its salts including PFOA-Na (CAS No.: 335-95-5), PFOA-K (CAS No.: 2395-00-8), PFOA-Ag (CAS No.: 335-93-3), PFOA-F (CAS No.: 335-66-0) and APFO (CAS No.: 3825-26-1);
- (2) ^ PFOS including PFOS-K (CAS No.: 2795-39-3), PFOS-Li (CAS No.: 29457-72-5), PFOS-NH₄ (CAS No.: 29081-56-9), PFOS-NH(OH)₂ (CAS No.: 70225-14-8), PFOS-N(C₂H₅)₄ (CAS No.: 56773-42-3), PFOS-DDA(CAS No.:251099-16-8) and POSF (CAS No.: 307-35-7)

Unless otherwise stated, the decision rule for conformity reporting is based on Binary Statement for Simple Acceptance Rule ($w=0$) stated in ILAC-G8:09/2019.



Unless otherwise agreed in writing, this document is issued by the Company subject to its General Conditions of Service printed overleaf, available on request or accessible at <http://www.sgs.com/en/Terms-and-Conditions.aspx> and, for electronic format documents, subject to Terms and Conditions for Electronic Documents at <http://www.sgs.com/en/Terms-and-Conditions/Terms-e-Documents.aspx>. Attention is drawn to the limitation of liability, indemnification and jurisdiction issues defined therein. Any holder of this document is advised that information contained hereon reflects the Company's findings at the time of its intervention only and within the limits of Client's instructions, if any. The Company's sole responsibility is to its Client and this document does not exonerate parties to a transaction from exercising all their rights and obligations under the transaction documents. This document cannot be reproduced except in full, without prior written approval of the Company. Any unauthorized alteration, forgery or falsification of the content or appearance of this document is unlawful and offenders may be prosecuted to the fullest extent of the law. Unless otherwise stated the results shown in this test report refer only to the sample(s) tested.

Attention: To check the authenticity of testing / inspection report & certificate, please contact us at telephone: (86-755) 8307 1443, or email: CN.Doccheck@sgs.com

ATTACHMENTS

Pb/Cd/Hg/Cr⁶⁺/PBBs/PBDEs Testing Flow Chart

1) These samples were dissolved totally by pre-conditioning method according to below flow chart. (Cr⁶⁺ and PBBs/PBDEs test method excluded).

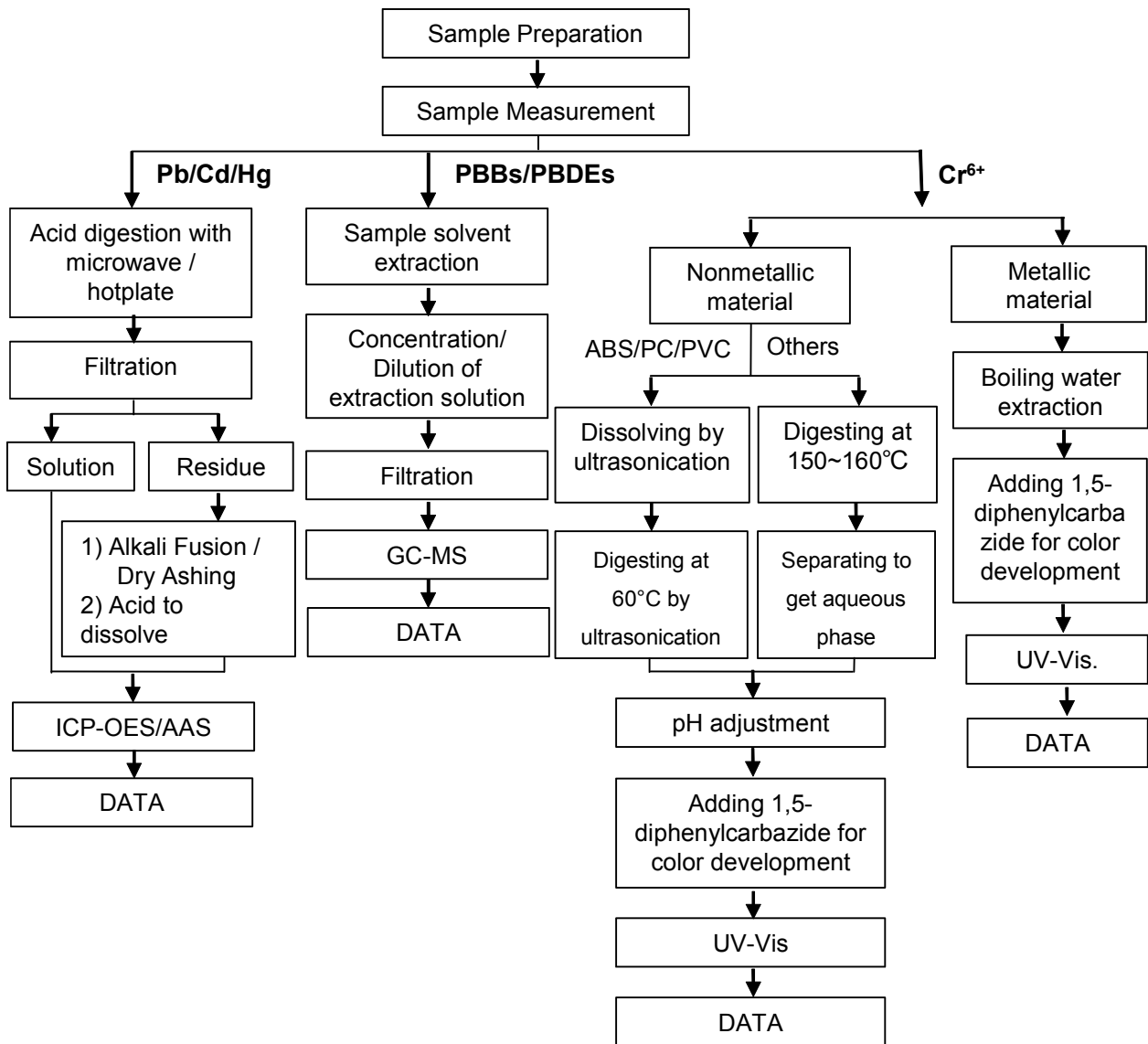

ATTACHMENTS

Phthalates Testing Flow Chart

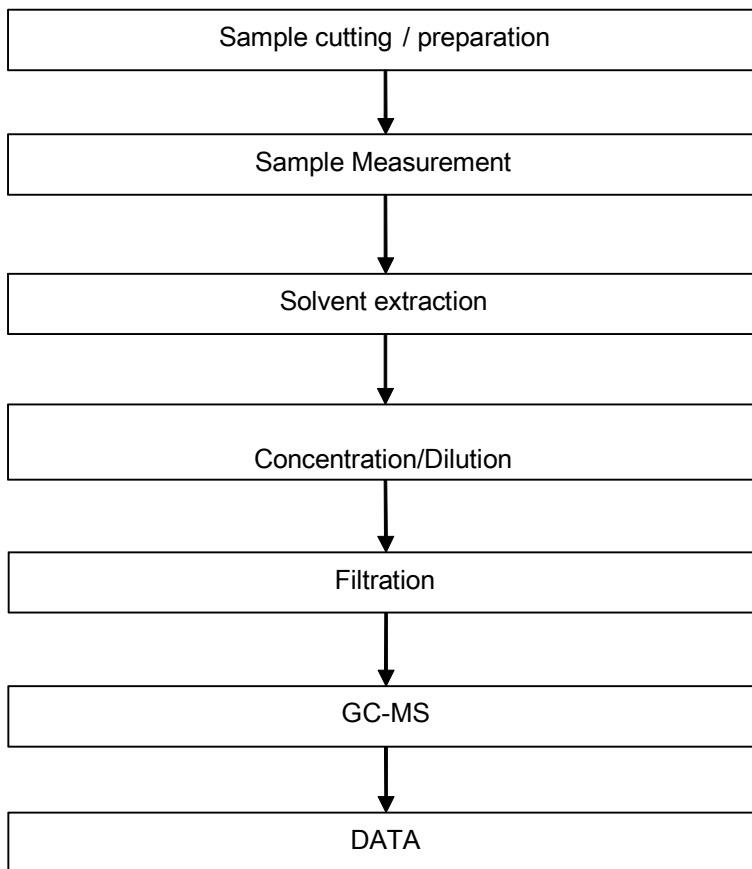

Unless otherwise agreed in writing, this document is issued by the Company subject to its General Conditions of Service printed overleaf, available on request or accessible at <http://www.sgs.com/en/Terms-and-Conditions.aspx> and, for electronic format documents, subject to Terms and Conditions for Electronic Documents at <http://www.sgs.com/en/Terms-and-Conditions/Terms-e-Document.aspx>. Attention is drawn to the limitation of liability, indemnification and jurisdiction issues defined therein. Any holder of this document is advised that information contained hereon reflects the Company's findings at the time of its intervention only and within the limits of Client's instructions, if any. The Company's sole responsibility is to its Client and this document does not exonerate parties to a transaction from exercising all their rights and obligations under the transaction documents. This document cannot be reproduced except in full, without prior written approval of the Company. Any unauthorized alteration, forgery or falsification of the content or appearance of this document is unlawful and offenders may be prosecuted to the fullest extent of the law. Unless otherwise stated the results shown in this test report refer only to the sample(s) tested.

Attention: To check the authenticity of testing / inspection report & certificate, please contact us at telephone: (86-755) 8307 1443, or email: CN_Doccheck@sgs.com

ATTACHMENTS

PFOA / PFOS Testing Flow Chart

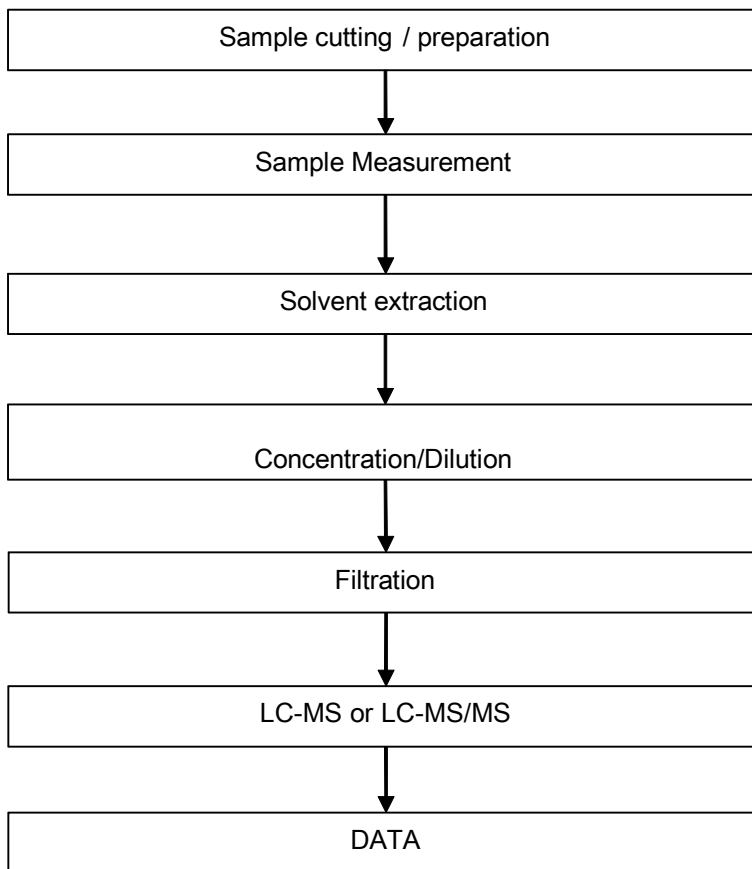

Sample photo:



SGS authenticate the photo on original report only

*** End of Report ***

