

承 认 书

Approval Sheet

客户 (Customer): /

客户料号 (Cus .P/N): /

华联威料号 (HLW P/N): 216104-1091-G63018

品名规格 (PronameSpec): FPC 高度2.0 间距 0.8 32PIN

送样日期 (Delivery Date): 2022/03/21

承认日期 (Acknowledge Date): 2022/03/21

Approved No:		客 户 Customer	
采 购 部 Purchasing Dept	品 质 部 QC Dept	工 程 部 Engineering Dept	确 认 Approved By
深 圳 市 华 联 威 电 子 科 技 有 限 公 司 SHEN ZHEN SHI HUA LIAN WEI ELECTRONICS TECHNOLOGY CO; LTD.			
业 务 部 Sales Dept	品 管 部 QC Dept	工 程 部 Engineering Dept	核 准 Checked By
万金菊	欠必锋	魏红	唐竹君

地址: 深圳市龙华区观澜街道桂香社区观澜桂花路 307 号

TEL: 0755-28888886 28888866

hua@hlwconn.com

[Http://www.hlwconn.com](http://www.hlwconn.com)

目 录

Contents

图纸.....	Page03
产品规格书.....	Page04-05
产品检测报告.....	Page06-07
尺寸测试报告.....	Page08
电镀报告.....	Page09
盐雾报告.....	Page10
材质证明.....	Page11-12
SGS.....	Page13-46

REV.	ECN.NO.	APPD.
A	XXXXXXXXXX	yangguifeng

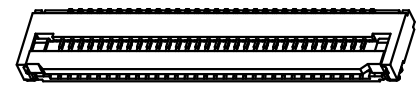
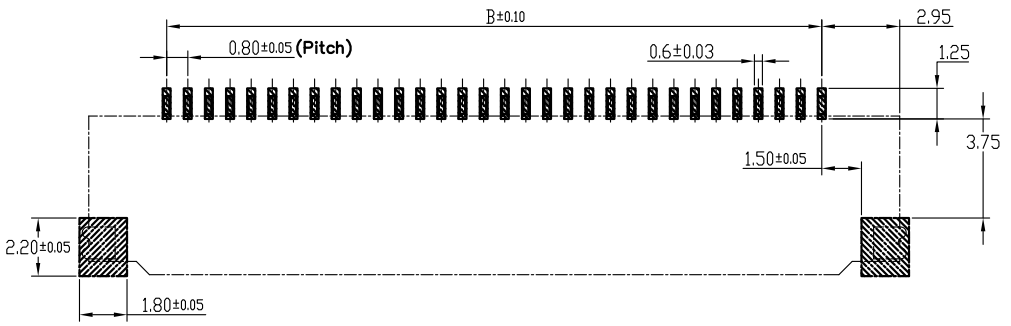
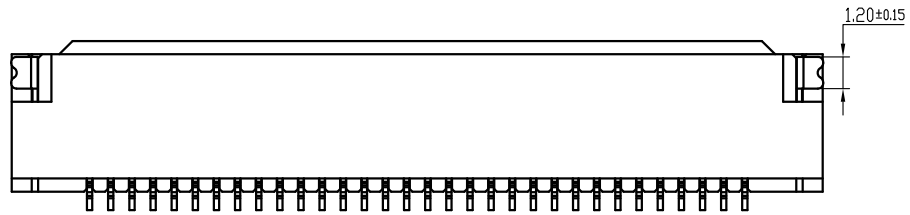
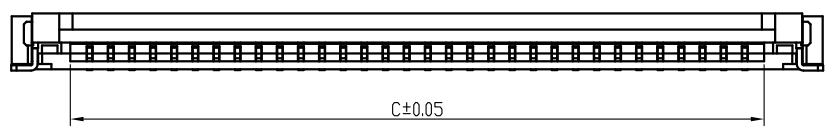
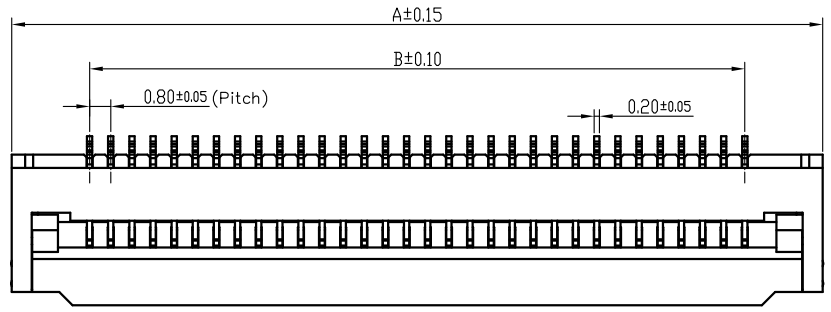

- Specifications:
1. Rated Voltage : 125V AC/DC
 2. Rated Current : 1A AC,DC
 3. Withstand Voltage : 200V AC/minute
 4. Contact Resistance : 50mΩ(MAX.)
 5. Insulation Resistance : 100MΩ(MIN.)
 6. Storage Temperature Range: -40°C~+85°C;
 7. Operation Temperature Range: -25°C~+70°C;

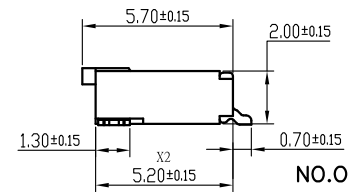

216104-1091-G63018
 G: 半金G/Fu 1: 吸塑盒
 6: LCP 3: 米黄色

NO.OF CONTACTS:(04Pin~60Pin)

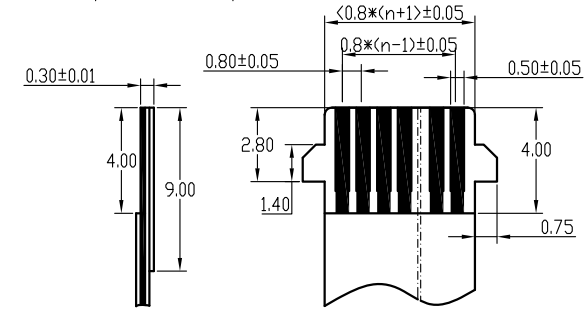

APPLICABLE FPC

No. of Contacts	DIM.		
	A	B	C
12	14.70	8.80	10.45
28	27.50	21.60	23.25
30	29.10	23.20	24.85
32	30.70	24.80	26.45
36	33.90	28.00	29.65

TOLERANCE UNLESS OTHERWISE SPECIFIED	
.XXX ±0.10	.X ±3'
.XX ±0.20	.XX ±2'
.X ±0.30	

FLW 深圳市华联威电子科技有限公司
 HUA LIAN WEI TECHNOLOGY ELECTRONICS CO;LTD.

APPROVED		PART NAME:	FPC 高度2.0间距0.8 32PIN			
CHECKED		PART No:	216104-1091-G63018	C		
DRAWN	yangguifeng	PROJECTION:	UNIT:	SCALE:	SHEET:	REV.:
DATE	2021.12.01		mm	1:1	1 OF 1	A

FPC系列產品SPEC

TEST ITEM		REQUIREMENT	PROCEDURE
1	Examination of Product	Meets requirements of product drawing. No physical damage.	Visual inspection.
2	Operating Temperature	-25°C ~+85°C	
3	Storage Temperature :	-25°C ~+85°C	
ELECTRICAL REQUIREMENT			
4	Rating Voltage	50V AC max	
5	Rating Current	0.5Amperes max	
6	Contact Resistance	[40]Milliohms Max.(Initial) [60]Milliohms Max.(Final)	Subject mated contacts assembled in housing to 40mV Max open circuit at 1A Max.
7	Dielectric withstanding Voltage	No creeping discharge or flashover shall occur.Current leakage: 0.5mA Max.	200V AC for 1minute Test between adjacent circuits of unmated connector.
8	Insulation Resistance	500M Ohm Min	Impressed voltage 200 VDC.Test between adjacent circuits of unmated connector.
Mechanical Requirement			
9	Connector Withdrawal Force	F(N)= P x 0.39 MIN (P: Number of Contacts) (With Black Slider) F(N)= P x 0.27 MIN (P: Number of Contacts) (With Brown Slider)	Operation Speed: 25mm/min.Measure the force required to mate connector.
10	Terminal & Solder Peg Retention Force	Test method complies with EIA-364-29	200gf MIN
11	Durability	See Note	Operation Speed : 200cycle/Hour.Durability Cycles : 20Cycles
12	Vibration	No electrical discontinuity greater than 1 μ sec shall occur.	Measure change in contact resistance after 2 hours of vibration in reach of the X,Y and Z directions. Frequency varying in 1 Minutes sweeping as 10~55~10 Hz with 1.5mm
13	Thermal Shock	5 Cycles - 55°C \pm 3°C for 30 minutes. +85°C \pm 2°C The connectors under test must be mated. There shall be no evidence of damage.	It shall be subjected to temperature cycle at the following condition 1 cycle consists of - 55°C \pm 3°C for 30 minutes. +85°C \pm 2°C for 30minutes . Time of cycles: 5 cycles. Test method complies with EIA-364-32
ENVIRONMENTAL REQUIREMENTS			
14	Solder ability	Wet solder coverage:95%Min	Solder Temperature : 260 \pm 5°C, Duration:5 \pm 0.5sec.
15	Resistance to Wave Soldering Heat	No physical damage shall occur.	Solder Temp. : 260 \pm 5°C, 10 \pm 1sec.

16	Salt spray test	Visual Inspection-No physical damageLLCR-60 mΩ max per contact	Mated connector expose to 5% salt concentration for 48 hours at temperature 35±2 °C .After the test specimens shall be washed with running water and dried naturally
----	-----------------	--	--

Product Qualification and Requalification test										
Test or Examination	Test Group									
	A	B	C	D	E	F	G	H	I	J
	Test Sequence (a)									
Examination of Product	1, 7	1, 9	1, 6	1, 5	1, 5	1, 5	1, 5	1, 3	1, 3	1, 3
Contact Resistance		2, 8	2, 5	2, 4	2, 4	2, 4	2, 4			
Dielectric withstanding	3, 6									
Insulation Resistance	2, 5									
Temperature Rising								2		
Mating Force		3, 7								
Unmating Force		4, 6								
Durability		5								
Vibration			3							
Mechanical Shock			4							
Solderability										2
Resistance to Soldering									2	
Thermal Shock				3						
Humidity Temperature	4				3					
Temperature Life						3				
Salt Spray							3			
備注	無客戶指定增加測試項目外，依照此標準進行產品可靠性評估。									

核准：唐竹君

制作人：魏紅

7	耐久性	测试速度：每分钟15个循环，测试次数：100次循环最少	插拔力計	不得发生物理损坏。	OK	OK	OK	OK	OK	V	
---	-----	-----------------------------	------	-----------	----	----	----	----	----	---	--

三. 环境特性测试 ENVIRONMENTAL TEST

序號 NO	測試項目 Testing Item	測試條件 Testing Conditions	測試設備 Testing Equipment	規格 SPEC	測試記錄Testing Result					判定 Judge	
					1	2	3	4	5	OK	NG
9	冷热冲击	温度-40±3℃ 温度105±3℃ 持续时间0.5H	高低温试验箱	不得发生物理损坏。	OK	OK	OK	OK	OK	V	
10	湿温循环	温度85℃±5℃， 持续时间:250H	湿温循环机	最大接触阻抗20mΩ	OK	OK	OK	OK	OK	V	
11	盐雾试验	温度:35±2℃ 12小时	盐雾试验箱	最大接触阻抗20mΩ	OK	OK	OK	OK	OK	V	
12	可焊性	焊锡温度: 260±5℃	熔锡炉	沾锡面积达90%以上	OK	OK	OK	OK	OK	V	
13	焊接耐热试验	260±5℃ 10秒	工业烘烤箱	不得发生物理损坏	OK	OK	OK	OK	OK	V	

綜合判定 TEST JUDGMENT	<input checked="" type="checkbox"/> 合格 (Acceptable) <input type="checkbox"/> 不合格 (Reject)										
-----------------------	---	--	--	--	--	--	--	--	--	--	--

核准(Approver): 欠必鋒 測試(Tester): 但芬



深圳市华联威电子科技有限公司

檢驗報告

首件檢驗
 入庫檢驗
 出貨檢驗
 客退檢驗
 退料檢驗
 其他
 2022年03月21日 版次:A1

料號	216104-1091-G63018	制令單號	/					送檢單位	工程	首件製作者	裝配		
品名	FPC 高度2.0间距0.8 32 PIN	客戶代號	/					批 量	/	送檢時間	/		
								數 量	5PCS	確認時間	/		
抽樣標準		<input checked="" type="checkbox"/> 單次 <input type="checkbox"/> 雙次					抽樣數	AQL	CRI:0	MAJ:0.4	MIN:0.6		
MIL-STD-105E(II)		<input checked="" type="checkbox"/> 正常 <input type="checkbox"/> 加嚴 <input type="checkbox"/> 減量					(5PCS)	ACC/RE.	0	/	/		
不良數:		CRI (/)		MAJ (/)		MIN (/)		不良率(%)		/			
NO.	檢驗項目 單位:MM/G	檢測 儀器	檢 驗 記 錄					品管判定		CRI	MAJ	MIN	備注
			1	2	3	4	5	AC	RE				
	30.70±0.15	D	30.72	30.75	30.73	30.75	30.72	√					
尺 寸 測 量	24.80±0.20	D	24.83	24.85	24.86	24.85	24.83	√					
	29.65±0.05	D	29.67	29.68	29.65	29.63	29.65	√					
	1.20±0.15	D	1.23	1.21	1.22	1.19	1.20	√					

檢驗依據: 《工程圖紙》 《檢驗規範》 《承認書》 樣品 其它

檢測儀器:A游標卡尺 B千分尺 C厚薄儀 D投影鏡 E放大鏡 F顯微鏡 G錫爐 H插拔力器 I間位尺 J其它

品保判定: 合格Accept 退貨Reject 特采Waive 挑選Sort

核准: 欠必鋒

審核: 李娟

檢驗員: 但芬

品名:FPC 高度2.0间距0.8 32PIN (端子)					
电镀规格:Ni40u", Sn40u", Au G/Fu"		日期:2021-12-20	页次:1/1		
厂商:同华					
测试设备:CMI X-射线膜厚测试仪					
1、底层电镀测试 (Ni)					
数据	测试标准	实测值	判定	测试日期	测试时间
1	40u"MIN	50.5u"	OK	2021/12/20	10:20:15
2	40u"MIN	56.3u"	OK	2021/12/20	10:20:17
3	40u"MIN	67.5u"	OK	2021/12/20	10:20:19
4	40u"MIN	62.4u"	OK	2021/12/20	10:20:21
2、表层电镀测试 (Sn)					
数据	测试标准	实测值	判定	测试日期	测试时间
1	40u"MIN	65.3u"	OK	2021/12/20	10:25:10
2	40u"MIN	74.7u"	OK	2021/12/20	10:25:12
3	40u"MIN	75.9u"	OK	2021/12/20	10:25:14
4	40u"MIN	70.4u"	OK	2021/12/20	10:25:16
3、表层电镀测试 (Au)					
数据	测试标准	实测值	判定	测试日期	测试时间
1	0.5u"MIN	0.56u"	OK	2021/12/20	10:30:32
2	0.5u"MIN	0.54u"	OK	2021/12/20	10:30:34
3	0.5u"MIN	0.57u"	OK	2021/12/20	10:30:36
4	0.5u"MIN	0.55u"	OK	2021/12/20	10:30:38

核准: 欠必锋

审核: 李娟

检验员: 但芬

盐水喷雾实验报告

试验方法	盐水喷雾腐蚀试验法	参考资料	MIL-STD-1216
METHOD	NEUTRL SALT SPRAY CORROSION TEST	REF	
客户	/	试验起始日期	2022年03月18日 20:00 时起
		DATE	2022年03月19日 08:00 时止
样品名称	FPC 高度2.0间距0.8 32PIN	试验数量	5PCS
P/N	216104-1091-G63018		

试验条件 (TEST CONDITION)

- 1、盐水溶解 (SALT SOLUTION: 浓度 $50 \pm 10\text{g/L}$, PH值6.5-7.2).
- 2、试验室温度 (TEMP. IT THE SPRAY DHAMBR): $35 \pm 1^\circ\text{C}$.
- 3、盐水桶温度 (TEMP. OF SALE SOL' N TANK): $35 \pm 1^\circ\text{C}$.
- 4、压力桶温度 (TEMP. OF SAR SUPPLIERY): $47 \pm 1^\circ\text{C}$.
- 5、试验室相对湿度 (R. H IN THE CHAMBER) 85%.
- 6、压缩空气压力 (COMPRESSED AIR PRESSURE): $1.00 \pm 0.01\text{Kg/cm}^2$.
- 7、样品放置位置 (SPECIMEN SUPPORTED ANGLE): 尼龙绳吊挂 $70^\circ - 90^\circ$.
- 8、喷雾收集量 (COLLECT RATE OF SALT SOL' N) $1-2\text{mL}/(8 \text{ cm}^2\text{hr})$.
- 9、盐雾测试时间: 12小时 (H)

判定方法 (ADFUSGD METHOD)

试验后以20倍放大镜观察、无蓝、绿色腐蚀物之现象 (不包含折弯处), 即判定合格. (Inspext the ecimen at 20 xmagnification no blue or green corrosion products are acceptable)

样品序号	试验后现象	判定
	PHENOMENON AFTER TEST	COMMENT
1	无蓝、绿色腐蚀物之现象	OK
2	无蓝、绿色腐蚀物之现象	OK
3	无蓝、绿色腐蚀物之现象	OK
4	无蓝、绿色腐蚀物之现象	OK
5	无蓝、绿色腐蚀物之现象	OK

核准: 欠必锋

审核: 李娟

试验员: 但芬

鉅鼎銅材廠檢驗報告單

公司名稱 Customer	鉅鼎銅材廠檢驗報告單				重量 Weight(kg)	1078	出貨日期 Date	2021/11/23		
品名 Article	標準 Standard No				尺寸 Dimension		狀態 Tenper	銅卷編號 Coil No		
C2680	JISH3100:2017				0.18*400		EH	1021-C-08		
化學成分Chemical Compositions(%)										
元素 Element	Cu %	Zn%	Pb%	Fe%	\	\	\	\	化學成分	雜質
規範 Spec	64.0-68.0	餘量	<0.05	<0.05	\	\	\	\	合格	合格
實測 Actual	64.32	餘量	0.0036	0.0136	\	\	\	\	合格	合格
機械性質Mechanical Properties										
項目 Item	結晶粒度 Grain Size Mm	硬度 Hardness Hv	抗拉強度 TensionStrength Mpa	伸長度 Elongation %	導電率 Electrical Conduc %IACS	彎曲試驗 Bending Test 180	表面粗度 Surface Roughness Ra(u m)	彎曲度 Camber mm/n		
規範MAX Spec	\	170-190	490-610	\	\	\	\	\		
實測 Actual	\	178	574	5	\	\	\	\		

品質部



东莞市海嵘兴塑胶有限公司

LCP材质分析报告

品 名	比 例	用 途
杜邦LCP树脂	0.68	构成材料主要成份
抗氧剂	0.003	抗氧化
日本住友TAP	0.002	润滑及增加流动性
大洋安定剂	0.005	稳定机械性能, 方便重复使用
玻纤	0.30	增强
色母	0.01	着色

注：以上数据真实可靠，但并非绝对值，并不做任何商业依据。

